

**Megapixel**

1280 x 960  
software zoom

**30 Frames/s**

VGA (640 x 480)  
10 F/s Mega

-22°F ... +140°F

**Weatherproof**

-30°C to +60°C, IP65  
no heating necessary

IEEE 802.3af

**PoE**

Power over Ethernet  
even in the Winter

Microphone & speaker

**Audio**

bi-directional via IP  
variable framerates

Video SIP Client

**IP Telephony**

alarm notify,  
cam remote control

**Video motion**

multiple windows  
precision pixel-based

Realtime audio

**Recording**

event-ringbuffer  
30 cams each 25 fps

**Live viewing**

30 cams at 25 fps  
all on one screen

**Backlight**

safe using CMOS  
without mechanical iris

Concealed cabling

**Wall bracket**

with cable cover  
for RJ45 wall outlet

**Robust**

no moving parts  
fiber glass housing

# Software Camera Manual

## Part 2

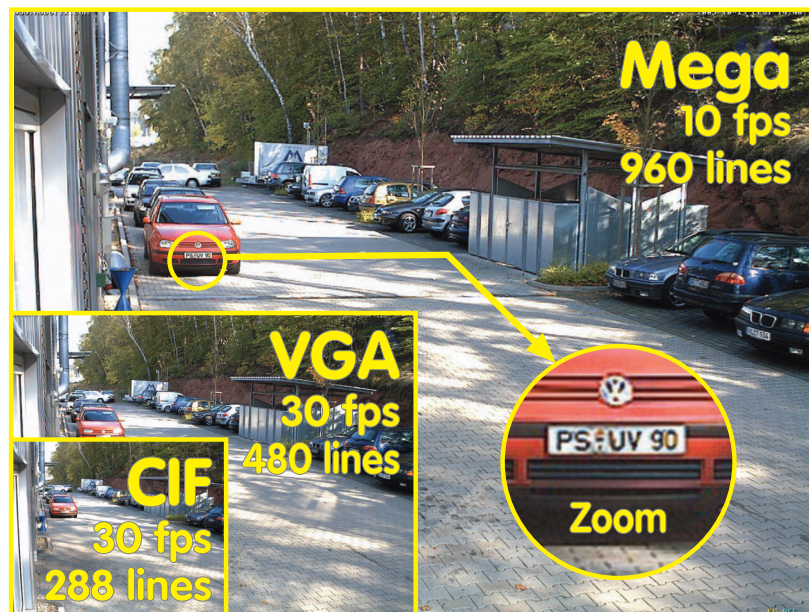

**Complete Integration for Web and Security**

Current PDF File:

[www.mobotix.com](http://www.mobotix.com) > Services > Manuals

MOBOTIX AG • Security-Vision-Systems • Made in Germany

[www.mobotix.com](http://www.mobotix.com) • [sales@mobotix.com](mailto:sales@mobotix.com) • 10.10.2006

Security-Vision-Systems

**MOBOTIX**.AG

**MOBOTIX ... the new face of IP video**

## Software Camera Manual Part 2

### MOBOTIX ... the new face of IP video

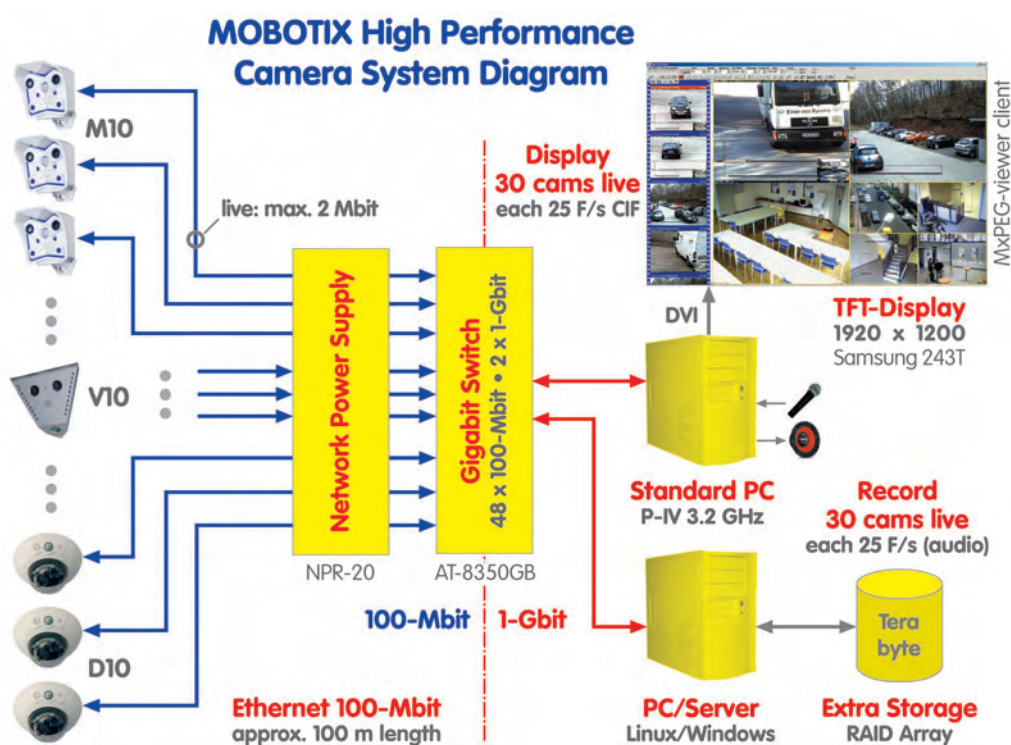

**Note:** MOBOTIX offers seminars that include a workshop and practical exercises:

**Basic Seminar** 2 days, **Advanced Seminar** 2 days.

For more information, see [www.mobotix.com](http://www.mobotix.com)

#### Note

Chapters 1 to 3 can be found in the *Camera Manual Part 1* for your camera.

<b>INTRODUCTION</b>	<b>6</b>
<b>4 CAMERA USER INTERFACE</b>	<b>8</b>
<b>4.1 The First Image in the Browser</b>	<b>8</b>
4.1.1 Additional Information	9
4.1.2 Camera Screens in the Browser	10
<b>4.2 The First Image in MxViewer</b>	<b>11</b>
<b>4.3 The Live Screen in the Browser</b>	<b>15</b>
4.3.1 Controls	15
4.3.2 Image Settings	22
4.3.3 Browser Settings, Operating Mode	24
4.3.4 Saving the Settings	25
4.3.5 JPEG, MxPEG and Audio	26
4.3.6 Background Information on JPEG, MxPEG and Audio	28
<b>4.4 The Playback Screen in the Browser</b>	<b>30</b>
4.4.1 Controls	30
4.4.2 Events and Storage Options	32
4.4.3 Recording Modes	34
4.4.4 Image Search Using Date & Time	36
4.4.5 Archiving	36
<b>4.5 The MultiView Screen in the Browser</b>	<b>37</b>
4.5.1 Controls	37
4.5.2 Defining Cameras	38
4.5.3 Configuring Image Areas	39
4.5.4 Creating Customized Screens	41
<b>4.6 PDA Screen</b>	<b>42</b>
4.6.1 Accessing the PDA Screen	42
4.6.2 Controls and Event List	42
<b>4.7 Guest Screen</b>	<b>44</b>
<b>4.8 Browser Settings</b>	<b>46</b>
<b>4.9 Configuring the Softbuttons</b>	<b>48</b>
4.9.1 Configuring a Softbutton	48
4.9.2 Managing Softbutton Functions	49
<b>4.10 Fast Video Streaming</b>	<b>51</b>
4.10.1 Overview	51
4.10.2 MOBOTIX Camera	51
4.10.3 Browser	52
4.10.4 MxViewer	53
4.10.5 Installing and Starting MxViewer	54
4.10.6 Windows Processes	55
<b>4.11 Operating Multiple Cameras</b>	<b>56</b>
4.11.1 Overview	56
4.11.2 Simultaneously Displaying Several Cameras with High Image Rates	57

<b>5</b>	<b>GENERAL CAMERA CONFIGURATION</b>	<b>60</b>
<b>5.1</b>	<b>Overview</b>	<b>60</b>
5.1.1	The Admin Menu	61
5.1.2	The Setup Menu	62
<b>5.2</b>	<b>Quick Installation</b>	<b>64</b>
5.2.1	Overview	64
5.2.2	Quick Installation Pages in Detail	66
<b>5.3</b>	<b>Connection Test</b>	<b>80</b>
<b>5.4</b>	<b>Basic Settings</b>	<b>82</b>
5.4.1	Users, User Groups, Passwords, Supervisor Mode	82
5.4.2	Date and Time / Time Zones and Time Server	92
5.4.3	LED Signals and LED Configuration	96
5.4.4	Language and Entry Page	100
5.4.5	Microphone and Speaker	102
<b>5.5</b>	<b>Image Controls</b>	<b>104</b>
5.5.1	Overview	104
5.5.2	General Image Settings	104
5.5.3	Text Settings	108
5.5.4	Placeholders and Variables in the Comment Field	110
5.5.5	Examples for Placeholders and Variables in the Comment Field	111
5.5.6	Compression Format and Image Quality	112
5.5.7	Color Settings (Color Profile and Saturation)	114
<b>5.6</b>	<b>Logos</b>	<b>116</b>
5.6.1	Overview	116
5.6.2	Managing Image Files	116
5.6.3	Logo Profiles	118
<b>5.7</b>	<b>Exposure Settings</b>	<b>122</b>
5.7.1	Overview	122
5.7.2	Automatic Exposure	122
5.7.3	Backlight Correction	123
5.7.4	Automatic Exposure Setting Parameters	124
5.7.5	Exposure Setting Options	124
5.7.6	Exposure Windows	125
5.7.7	Setting the Exposure Windows	126
5.7.8	Custom Exposure Windows (Extra)	128
5.7.9	Exclusion Windows	129
<b>5.8</b>	<b>Day &amp; Night Modes</b>	<b>130</b>
5.8.1	Overview	130
5.8.2	Reduction of Dark Noise	131
5.8.3	Configuration Hints	131
<b>5.9</b>	<b>Managing Settings</b>	<b>132</b>
5.9.1	Overview	132
5.9.2	The Configuration File	132
5.9.3	Loading Configuration Files	134
5.9.4	Copying Configuration Files to Other Cameras	135



<b>6</b>	<b>SOFTWARE UPDATES</b>	<b>136</b>
6.1	Overview	136
6.2	Preparatory Steps	136
6.3	Updating the Camera Software	137
6.4	Update Checklist	139
<b>7</b>	<b>EVENTS, ACTIONS AND MESSAGES</b>	<b>140</b>
7.1	Overview	140
7.2	Functional Overview	142
7.3	General Procedure	143
7.4	Screen Display of Event Settings in Live Image	144
7.5	Arming	146
7.6	Events	151
7.6.1	Event Selection	151
7.6.2	Video Motion Detection	159
7.6.3	Event Filter (EC Event)	166
7.6.4	Event Logic (EL Event)	167
7.7	Actions and Messaging, Action and Messaging Profiles	169
7.7.1	Signal Out (Action SO)	172
7.7.2	File Transfer (Action FT)	173
7.7.3	Visual Alarm (Action VA)	174
7.7.4	Sound on Event (Message SD)	174
7.7.5	E-Mail Action (Message EM)	175
7.7.6	Phone Call-Out (Message CL)	175
7.7.7	IP Notify (Message IP)	175
7.8	Working with Profiles	176
7.8.1	Overview	176
7.8.2	FTP Profiles	177
7.8.3	E-Mail Profiles	180
7.8.4	Phone Profiles	183
7.8.5	IP Notify Profiles	186
7.8.6	Time Tables	189
7.8.7	Image Profiles	192
7.8.8	Logo Profiles	195
7.9	Time Tasks	198
7.9.1	Overview	198
7.9.2	Time Tasks	198
7.9.3	Scheduled Tasks Using the Time Task Event (TT)	202
<b>8</b>	<b>RECORDING</b>	<b>204</b>
8.1	Overview	204

<b>8.2</b>	<b>Recording Modes</b>	<b>208</b>
8.2.1	Configuring the Recording Modes	208
8.2.2	General Settings of the Recording Modes	209
8.2.3	Settings of Snap Shot Recording	210
8.2.4	Settings of Event Recording	212
8.2.5	Settings of Continuous Recording	214
8.2.6	Settings of History Recording	216
<b>8.3</b>	<b>Recording Types</b>	<b>218</b>
8.3.1	Recording in the MOBOTIX Camera	218
8.3.2	Recording on External File Servers	219
8.3.3	Recording on a Windows Computer	220
8.3.4	Recording on a Linux/UNIX Computer	226
8.3.5	Recording on a Mac OS X Computer	230
8.3.6	Notes on the Storage Folder Structure	234
<b>9</b>	<b>TELEPHONY FEATURES</b>	<b>236</b>
<b>9.1</b>	<b>Overview</b>	<b>236</b>
<b>9.2</b>	<b>VoIP Settings for IP Telephony</b>	<b>238</b>
<b>9.3</b>	<b>Camera Phone (Listen, Speak and Intercom Modes)</b>	<b>241</b>
<b>9.4</b>	<b>Phone Profiles: Outbound Phone Calls</b>	<b>242</b>
<b>9.5</b>	<b>Phone Call-In: Inbound Phone Calls</b>	<b>245</b>
<b>9.6</b>	<b>Remotely Controlling the Camera Using a Phone</b>	<b>248</b>
<b>9.7</b>	<b>Sample Configurations for IP Telephony via Internet</b>	<b>252</b>
9.7.1	Overview	252
9.7.2	Configuring a MOBOTIX Camera	253
9.7.3	Setting up an IP Phone	257
9.7.4	Setting up a Softphone	259
<b>9.8</b>	<b>Sample Configurations for IP Telephony via LAN</b>	<b>260</b>
9.8.1	Overview	260
9.8.2	Configuring a MOBOTIX Camera	261
9.8.3	Setting up an IP Phone	265
9.8.4	Setting up a Softphone	267
<b>9.9</b>	<b>Video Telephony</b>	<b>268</b>
9.9.1	Overview	268
9.9.2	Remotely Controlling the Camera Using a Softphone	269
9.9.3	Video Telephony Example: Intercom System	270
9.9.4	Configuring a MOBOTIX Camera for Video Telephony	272
9.9.5	Configuring a Softphone for Video Telephony	273
	<b>INDEX</b>	<b>274</b>

**The following chapters of the manual are still under development! Download the PDF file from [www.mobotix.com](http://www.mobotix.com)**

## 10 MOBOTIX CAMERAS ON THE WEB

- 10.1 Overview
- 10.2 Displaying Cameras on the Web
- 10.3 Configuring Routers and Firewalls
- 10.4 Configuring DynDNS
- 10.5 Updating Web Pages

## 11 SOFTWARE INTERFACES

- 11.1 Overview
- 11.2 Accessing Live Images
- 11.3 Accessing the Second Image Channel
- 11.4 Video Streaming
- 11.5 The HTTP API

## 12 TROUBLESHOOTING

- 12.1 Overview
- 12.2 Troubleshooting Checklist
- 12.3 Diagnostic Tools of the Camera
- 12.4 Monitoring Tools of the Camera
- 12.5 Other Problems
- 12.6 Additional Information
- 12.7 Sending Back the Camera
- 12.8 Warranty

### Note

Download the newest version of this document as a PDF file from [www.mobotix.com](http://www.mobotix.com).

More information:  
[www.mobotix.com](http://www.mobotix.com)

**Technical information subject to change without notice!**  
**No part of this manual may be reproduced by any means without our written approval!**  
**Copyright © MOBOTIX AG, Kaiserslautern, Germany**

## INTRODUCTION

### One Camera, Two Manuals

The accompanying documentation of a MOBOTIX camera consists of **two manuals**: The **Camera Manual Part 1**, which is different for each camera model and the **Camera Software Manual Part 2**, which is the same for all cameras.

Apart from this **Introduction**, the **Camera Manual Part 1** contains instructions for **Installing** and **Operating** the corresponding MOBOTIX camera (**M22**, **D12**, **M12**, etc.) as well as information on the hardware features and other information, e.g. the drilling templates for each model.

The model-specific **Camera Manual Part 1** is structured as follows:

- 1 **Introduction**
- 2 **Mounting the Camera**
- 3 **Operating the camera**

This **Camera Software Manual Part 2** describes the software features of all models and model variants; it should guide you through the numerous features that are inherent to MOBOTIX cameras.

### Model Feature List

The **Camera Software Manual Part 2** describes **all** software features of all MOBOTIX camera models and model variants.

The adjacent icon indicates all sections of the manuals, where differences in the **software functionality of the different models and model variants** are present. In this case, you should consult the *Software Features of all Models* table on the opposite page to see if your model has the corresponding feature.

As the features are constantly updated, you should consult the **Products > Feature Overview** file on [www.mobotix.com](http://www.mobotix.com) for the most recent information on the software features of your model.

## Typographic Conventions

### User Input

If the user is supposed to enter information, the corresponding text is shown using the `Courier` or **Courier bold** fonts.

### Controls of the User Interface

Controls and labels of the user interface are shown in **bold** print.

### Cross References

Cross references to other chapters or sections are shown in *italics*.

To download the newest version of these manuals as PDF files, open [www.mobotix.com](http://www.mobotix.com), **Services > Manuals**.

This icon indicates sections, where different models have different software features

Kameramodel	
X	-
X	-
-	X
-	X



	<b>Basic Models</b>	<b>Web Models</b>	<b>IT Models</b>	<b>Secure Models</b>
<b>Software Features (All Models)</b>				
Digital zoom (2x, 4x) with panning		X		X
Motion JPEG/MxPEG video streaming	X/X	X/X	X/X	X/X
Custom exposure windows	X	X	X	X
Video Motion Detector	X	X	X	X
Time and event control (FTP, email, logos)	X	X	X	X
Time tables definable	X	X	X	X
Web functionality (FTP, email)	X	X	X	X
Quad/MultiView in browser	X	X	X	X
Recording/Playback in browser	X	X	X	X
Logo generator, animated		X	X	X
Single image recording (pre-/post-alarm images)	3	3	10	50
Terabyte ring buffer (Win/Lin/Mac) via network			X	X
Continuous video/audio recording, 0.2 to 30 fps			X	X
Video/audio recording (event-triggered)			X	X
Event-controlled frame rate with continuous sound			X	X
Flexible event logic				X
Master/Slave arming by one camera				X
Scheduled privacy zones, several areas				X
Bidirectional audio (IP) from/to browser			X	X
Customized voice messages			X	X
VoIP telephony (Audio/Video, SIP)			X	X
Alarm calls to softphones (SIP) e.g. Xten			X	X
Remote alarm notification (via TCP/IP, IP Notify)			X	X
RS232 Data Logger/Terminal			X	X
Programming interface/HTTP API			X	X
<b>Model Limitations</b>				
Image size	VGA	Mega	VGA	Mega
Image sensor (color / B/W)	Color	Color	Color & BW	Color & BW
Standard lens for software version	L43	L43	L22	L22
Audio support (Microphone/Speaker)	-/S	-/S	M/S	M/S

This chapter contains valuable information! Read carefully!

## 4 CAMERA USER INTERFACE

Once the Ethernet connection has been established (see section 3.4.1 of the *Camera Manual, Preparing the Ethernet Connection*), you have the following possibilities to see **the first image of the camera**:

- **Direct access using a browser** (section 4.1, *The First Image in the Browser*)
- **Display the camera using MxViewer** (free Windows client for MOBOTIX cameras; section 4.2, *The First Image in MxViewer*)

Open the browser-based user interface of the camera to **complete the remaining configuration tasks** (see section 4.3, *The Live Screen in the Browser*).

### 4.1 The First Image in the Browser

Now that you have successfully started the camera for the first time, you can access the camera using your preferred browser to see the live video stream and the user interface.

Internet Explorer, Mozilla, Firefox, Safari, Camino or any other graphical browser with activated JavaScript is suitable. The operating system is of no importance, even PDAs can be used without any problems.

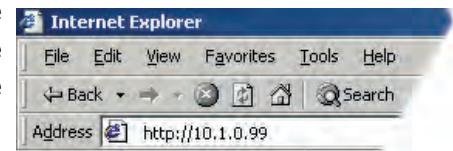

Camera access:

http://10.1.0.99 (example IP)

The factory IP address is printed on the sticker on the camera

Administration menu:

User name: **admin**

Password: **meinsm**

Softbuttons are **freely configurable**

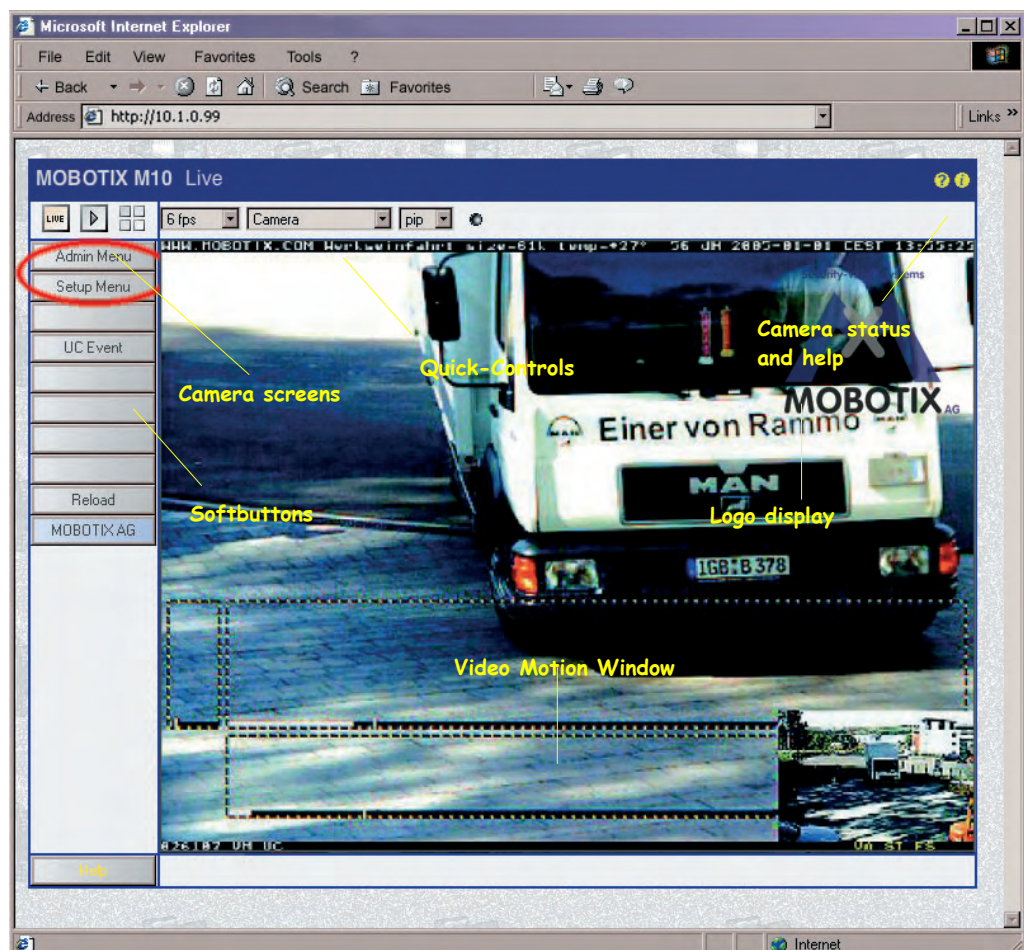

After entering the camera's IP address in the browser address bar (e.g. <http://10.1.0.99>), you will see the Live screen of the MOBOTIX camera with its user interface controls, such as **softbuttons**, buttons for the different **camera screens**, **pull-down menus** (*Quick Controls*), icons for accessing the **online help** and the **camera status**, as well as status information elements above and below the live image.

#### Note

**Factory Defaults:** Every MOBOTIX camera has its individual factory IP address (e.g. [10.1.0.99](http://10.1.0.99)). If you have started the camera using DHCP or you have set the IP address manually, use the new IP address (e.g. [192.168.0.99](http://192.168.0.99)) instead of the factory IP address. Pressing the **"R" key** of the camera will prompt the camera to announce its current IP address over the speaker. For additional information on this topic, see section 3.5, *Starting the Camera With an Automatic IP Address (DHCP)*, in the corresponding *Camera Manual*.

**Troubleshooting:** If your web browser does not show the camera's Live screen after you have entered the IP address, you should try to locate and resolve the error as described in chapter 12, *Troubleshooting*.

**MxViewer:** In order to see the live image of the camera, you can also use other applications or the integrated programming interface of the MOBOTIX camera. **MxViewer** for Windows is such an application and is provided **free of charge** by MOBOTIX. Besides its ability to display fast live video of up to **30 cameras with 30 fps each** on one PC, MxViewer also allows recording and playing back video clips with real-time audio via the network and can control pan/tilt heads using a joystick or the mouse. Download the newest version of MxViewer from the MOBOTIX website. The website contains more information on MOBOTIX systems as well as the MxViewer help.

Changing the factory IP address: Admin Menu > Ethernet Interface

Free download:  
[www.mobotix.com](http://www.mobotix.com)

#### 4.1.1 Additional Information

For more information on this topic, see the **News** and **Functional Overview** pages in the online help of the camera's browser interface. Click on the yellow  icon in the top right corner to open the camera's online help.

In order to get more information on the camera and its current configuration, open the **Camera Status** dialog by clicking on the yellow  icon in the top right corner of the camera's browser interface.

Another source of information on all dialogs and parameters of the MOBOTIX camera is the **Reference Manual** that you can download from [www.mobotix.com](http://www.mobotix.com).

 Camera Help

 Camera Status



Use the Administration menu to set the camera screen that should appear initially when accessing the camera IP address (**Admin Menu > Language and Entry Page**)



<http://10.1.0.99/pda> opens the PDA screen

**Live/Playback/MultiView:** Click on  to open the online help pages for the camera screens

#### 4.1.2 Camera Screens in the Browser

By factory default, the MOBOTIX camera first shows the **Live** screen. You can set a different entry page in order to prevent others from changing settings; you can assign user names and passwords to prevent unauthorized access or you can restrict access to the current live image only, by setting the **Guest** screen as entry page.

##### The following screens are available:

- **Guest** screen: Only shows the current live image with reduced frame rate.
-  **Live** screen: Shows the current live image and allows changing the image and event settings of the camera.
-  **Playback** screen: Shows all recorded images or video clips with extended functions for searching and downloading images, regardless of where the images are stored (in the internal or the external ring buffer on a file server or PC).
-  **MultiView** screen: Shows multiple cameras or the last events in a freely definable layout.
- **PDA** screen and **PDA Event List**: Both screens are optimized for PDAs with a focus on fast data transmission with low bandwidth requirements (GSM, GPRS) on devices with small displays (PDAs, mobile phones, sub notebooks). The PDA Event List in particular gives a quick overview of the last events since the live image of the camera is not transferred.

##### Note

Open **Admin Menu > Language and Entry Page** to set a different start page when accessing the camera.

Open **Admin Menu > Users and Passwords** and **Admin Menu > Group Access Control Lists** to set user rights and to prevent unauthorized access to certain screens (see section 5.4.1, *Users, User Groups, Passwords, Supervisor Mode*).

For more information on camera screens, see the **online help** of the camera's browser interface. Click on the yellow  icon in the top right corner of the Live screen to open the corresponding page of the online help.



## 4.2 The First Image in MxViewer

The **MOBOTIX MxViewer** is a free Windows application that allows displaying **multiple MOBOTIX cameras** on one computer and provides alarm management functions. It can easily handle displaying **30 cameras with CIF resolution (320x240 pixels)** at **30 fps each** in **MxPEG** format on one standard PC with Intel Pentium 4 and 3 GHz.

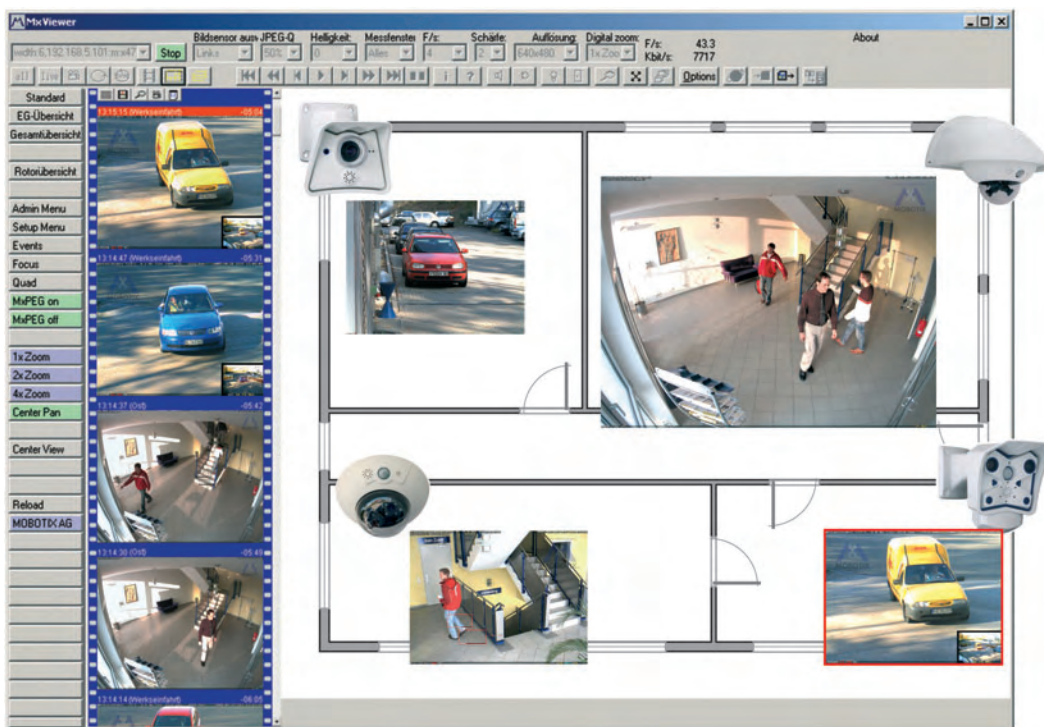

MxViewer can do quite a bit more than simply display the video and audio data from MOBOTIX cameras. The unique features of the **MOBOTIX MxViewer** with one or more MOBOTIX cameras create a full-featured security system with intelligent alarm handling, extensive possibilities of arranging the cameras on layouts (MultiView screens), ability to display cameras that are sending alarm notifications and integrated camera management functions.

Download MxViewer  
free of charge from  
[www.mobotix.com](http://www.mobotix.com)

**MxViewer** Windows client  
with background image  
and freely positionable  
cameras

Free download of  
MxViewer!

### Installing and Starting MxViewer

Follow these steps to install MxViewer:

- Download the newest version of MxViewer:  
[www.mobotix.com/services/software\\_downloads/](http://www.mobotix.com/services/software_downloads/)
- Download and install the **MSI** file (Windows Installer file).

You can also download the **EXE** file for manual installation:

- Download the **EXE** file to a suitable folder.
- Create a shortcut by right-clicking on **MxViewer.exe** in this folder.
- Copy the shortcut to the desktop.

Double-click the shortcut or the program file itself to start MxViewer.

### Defining Video Sources

If you start MxViewer for the first time on a computer without having defined any video sources (MOBOTIX cameras) before, the **MxViewer Video Sources** dialog will appear.

Depending on the task at hand, select the appropriate option in the **Select video sources** group:

- **Scan network for MOBOTIX cameras** (default): Click on **OK** to open the **Scan Network for MOBOTIX Cameras** dialog. The camera will automatically scan the subnet for MOBOTIX cameras and will display the list of camera IP addresses.

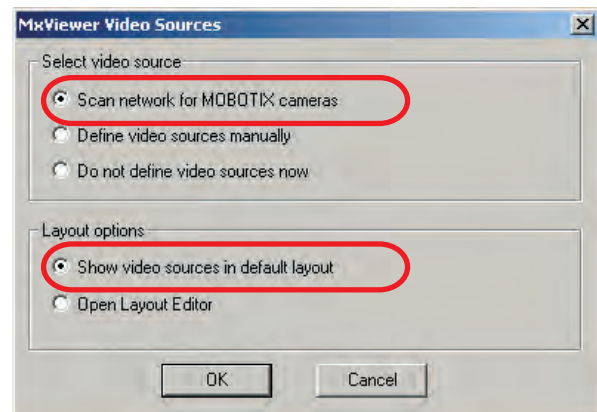

- **Define video sources manually**: Click on **OK** to open the **Define Video Sources Manually** dialog and manually add the cameras.

In the **Layout options** group, select **Show video sources in default layout**. This will prompt MxViewer to automatically generate a standard layout that comprises all video sources (i.e. cameras) once they have been defined either automatically or manually.

You should always let the camera search automatically for other MOBOTIX cameras

**Automatically Searching MOBOTIX Cameras in the Same Subnet**

MxViewer displays the **Scan network for MOBOTIX cameras** dialog:

- Click on the **Subnet** dropdown list and select the desired subnet.
- Click on **Scan** to start the camera search.

If MxViewer finds only one subnet, the scanning process will start automatically.

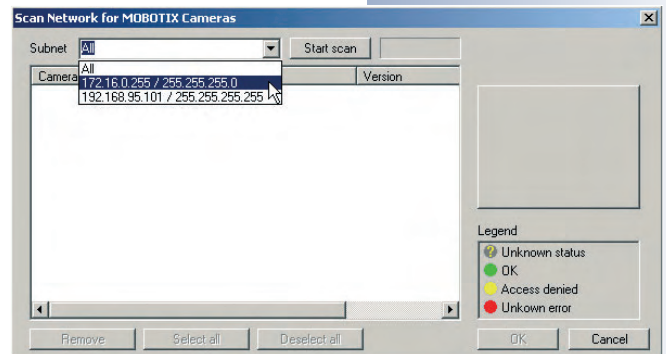

In the first pass, MxViewer searches the selected subnet for MOBOTIX cameras and in the second pass, MxViewer verifies if it can access the cameras.

MxViewer then highlights all cameras in the list, which have a status of *OK* or *Access denied*:

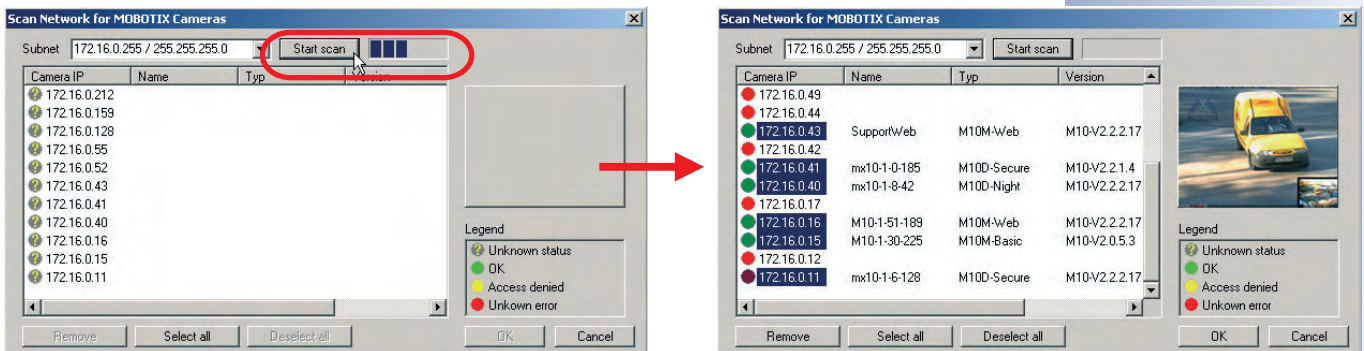

**Using the Highlighted Cameras**

Click on **OK** to use the *highlighted* cameras and to include them in the default layout generated by MxViewer:

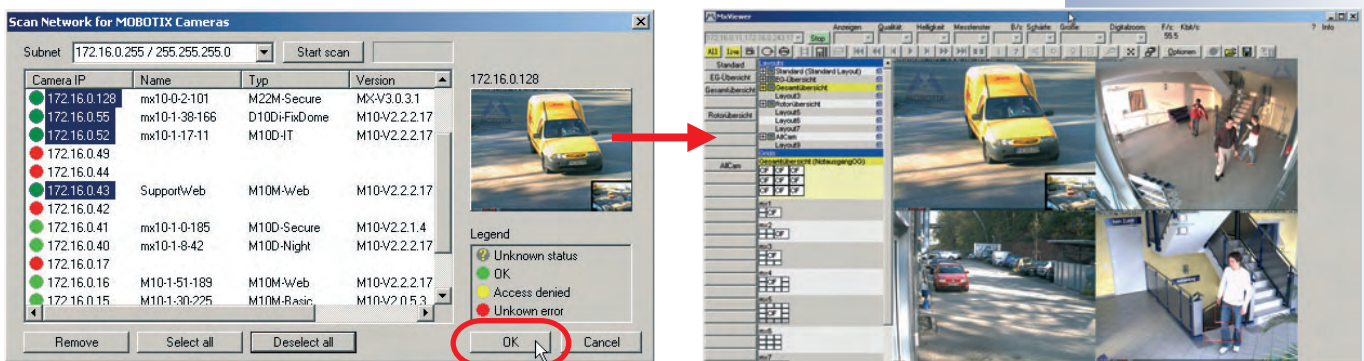



Enhanced search features

### Automatically Searching MOBOTIX Cameras in all Subnets

Future versions of MxViewer will be able to search MOBOTIX cameras not only in the current subnet of the computer, but also in all subnets, which can be reached within the same physical network (e.g. not closed off by routers or other mechanisms).

This means that MxViewer can find cameras with factory IP address (e.g. 10.1.0.99 as in our sample), although the computer is in a different subnet (e.g. 172.16.0.0).

**MxViewer can thus find MOBOTIX cameras automatically and without changing the computer configuration if the camera has been plugged into the same switch as the computer, for example.**

### Manually Defining MOBOTIX Cameras

If you have selected the **Define video sources manually** option in the **MxViewer Video Sources** dialog, you can manually add the IP addresses or DNS names of the MOBOTIX cameras.

- **Add:** Add the IP address or DNS name of the MOBOTIX camera you entered to the list.

If possible, MxViewer shows the image of the last camera you added in the preview window. Click on **OK** to use *all* cameras in the list and to include them in the default layout generated by MxViewer:

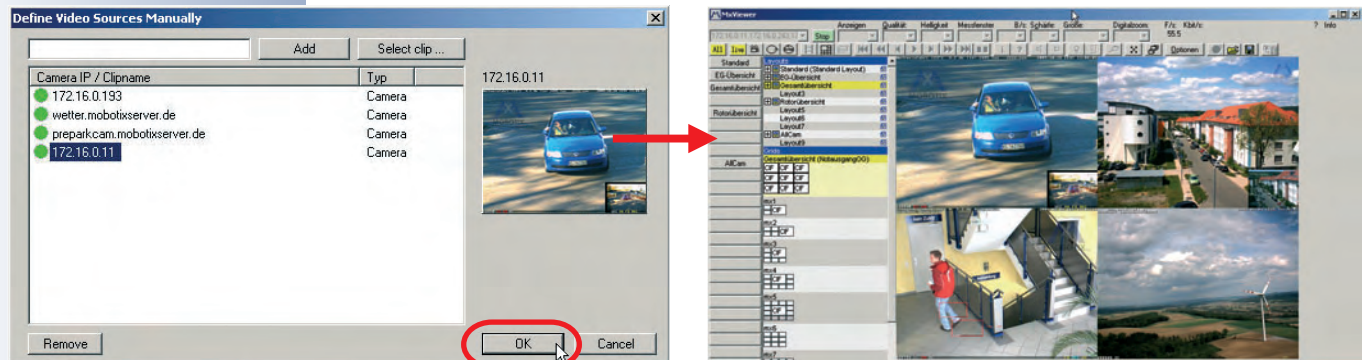

MxViewer can show multiple MxPEG clips at once!

### Displaying MxPEG Video Clips

MxPEG video clips represent the files that contain the video and audio data stored by either MOBOTIX cameras or MxViewer. These clips can be displayed in MxViewer just like the camera images. In order to display one or more MxPEG video clips, activate the **Layout Editor**, right-click the desired camera windows of the layout one by one and select the **Load Clip** command.

To download sample MxPEG video clips, open the MOBOTIX website [www.mobotix.com](http://www.mobotix.com).



### 4.3 The Live Screen in the Browser

#### 4.3.1 Controls

 The Live screen shows the camera's live image using the selected image resolution (size). This screen allows setting the most prominent image parameters, executing important functions and getting specific camera information. Icons, displayed text, the status bar, the Quick Controls above the Live image and other display elements within the Live image help getting the required information.

**Screen selection:**

- Live
- Player
- Multiview

**Quick Controls** (can be disabled):

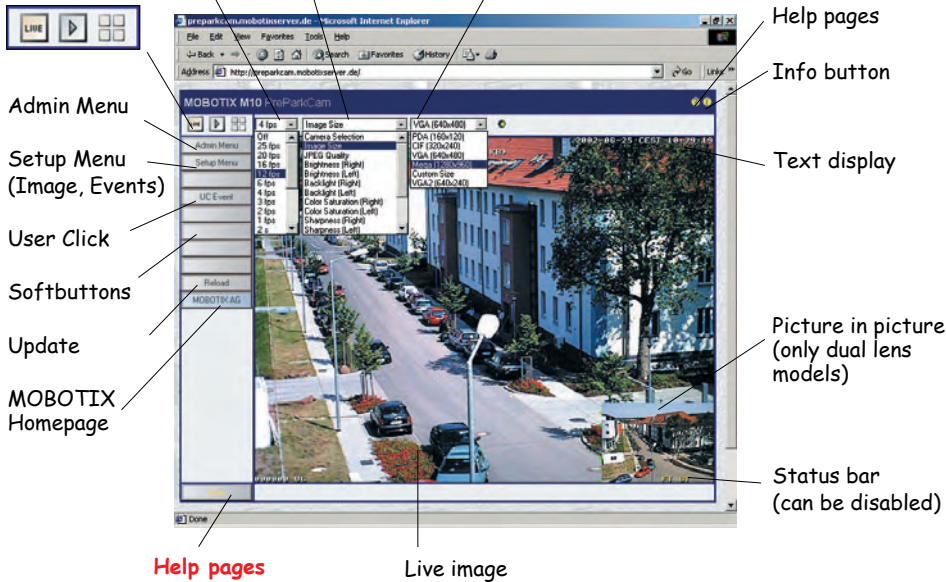

Frame rate Image settings Parameters





Quick Control  
**Manage Settings >**  
**Store Complete Configuration** to store the settings permanently

The help pages contain links to more information and hints on certain topics

#### Icons

The three **screen icons** in the upper left corner allow switching between the **Live**, **Playback**, and **MultiView** screens. The  icon will open the camera's online help, the  icon displays information about the camera's operating parameters.

-  Online help
-  Camera status

#### Text Display

The **text** displayed in the upper left corner of the live image can be customized and positioned freely anywhere in the image, or it can be hidden (**Setup Menu > Text & Display Settings**). In order to improve readability, you can select different background colors (with adjustable transparency) for the text in the live image. The text itself can also be displayed in different colors. Apart from simple texts, the camera can display status information using variables, e.g. camera IP address, image size in bytes, time of the last event, frame rate, text transferred from external devices using the serial interface, etc. For additional information on this topic, read section 5.5.4, *Placeholders and Variables in the Comment Field*, as well as *Placeholders for Dynamic Image Text* in the camera help and the reference manual.

Kameramodell	X	-
Kameramodell	X	-
Kameramodell	-	X
Kameramodell	-	X

## Event Symbols:

UC: User Click

VM: Video motion  
detection

## Action Symbols:

VA: Visual Alarm

REC: Recording

FS: File Server

FT: FTP file transfer

Softbuttons can be customized to execute specific functions.

## Administration menu:

User name: **admin**Password: **meinsm**

## Status Bar

The **event status bar** at the bottom of the live image displays the event control and the recording status, the number of stored events (alarms) as well as other messages (e.g. when actions or messages cannot be executed). Like the regular text, the event status bar can also be hidden (**Setup Menu > Text and Display Settings**). For additional information on this topic (camera symbols and the corresponding events, actions, messages and recording modes), see the **camera help** and the **reference manual**.

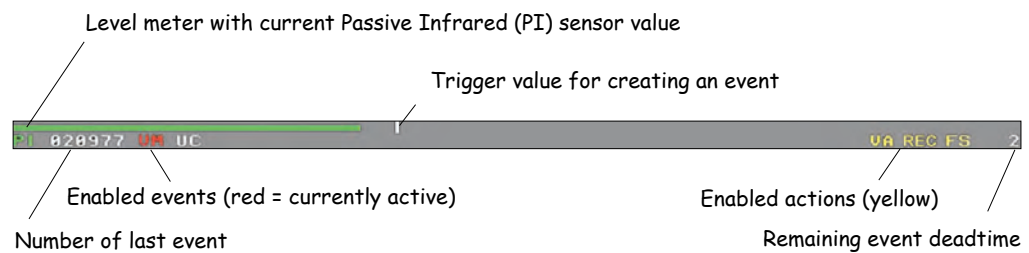

## Softbuttons

The **softbuttons** on the left side of the **Live**, **Player** and **MultiView** screens allow executing various camera functions and configuration tasks with one click. These buttons can be adapted to execute customized functions and to show different button background colors. For your convenience, the factory configuration of the user interface displays several preset softbuttons. For additional information on this topic, see chapter 4.9, *Configuring the Softbuttons*.

- **Admin Menu:** Clicking this button will open the administration menu, which controls the settings for Ethernet, ISDN, FTP, e-mail, external ring buffer (file server), the serial interface (RS232), telephony and other hardware parameters. This screen is only accessible for users, which belong to the **admins** user group.

**Note:** You can remove the **Admin Menu** button ([Shift]-click the softbutton); after that, accessing the Admin menu is only possible using the direct link: **http://10.1.0.99/admin**.

- **Setup Menu:** This menu allows changing the recording parameters, the image settings and the event control settings, e.g. activating events or assigning actions and messages to events takes place in the dialogs of this menu.

**Note:** You can remove the **Setup Menu** button ([Shift]-click the softbutton); after that, accessing the Admin menu is only possible using the direct link: **http://10.1.0.99/control**.

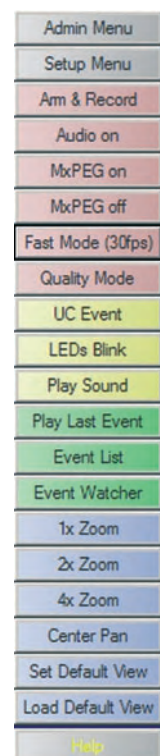

Expanded Softbuttons

- Arm & Record:** This button opens the **Arm and Record** dialog. Clicking on the **Yes** button will set the most important parameters that are required to arm the camera and to record the alarm images. The dialog itself contains a list of the settings that will be changed.

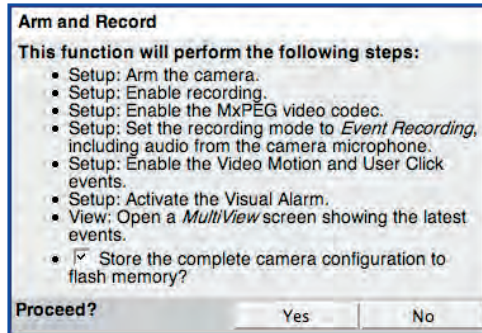

- Audio on:** This button opens the **Enable Audio** dialog. Clicking on the **Yes** button will set the parameters that are required to transmit the sound from the camera microphone to the browser. You will then hear the audio channel of the camera microphone on your PC speaker.

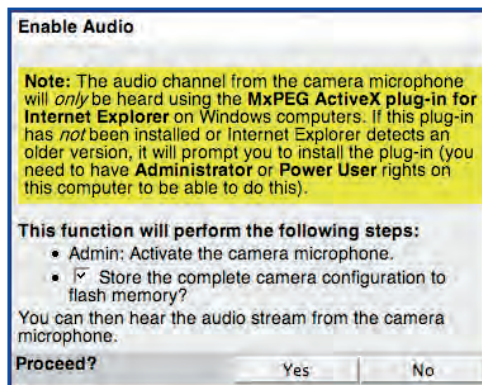

**Note:** This feature is only available when using an ActiveX-capable browser (Internet Explorer under Windows).

- MxPEG on** and **MxPEG off:** These buttons activate the MxPEG codec (*MxPEG on*) or the JPEG codec (*MxPEG off*) for generating images. For additional information on this topic, see sections 4.3.5 and 4.3.6 of this manual.

- Fast Mode (30 fps):** This button opens the **Fast Mode (30fps)** dialog. Clicking on the **Yes** button will set the parameters that are required to obtain the fastest possible frame rate in the browser window, while maintaining an acceptable image quality. The dialog itself contains a list of the settings that will be changed.

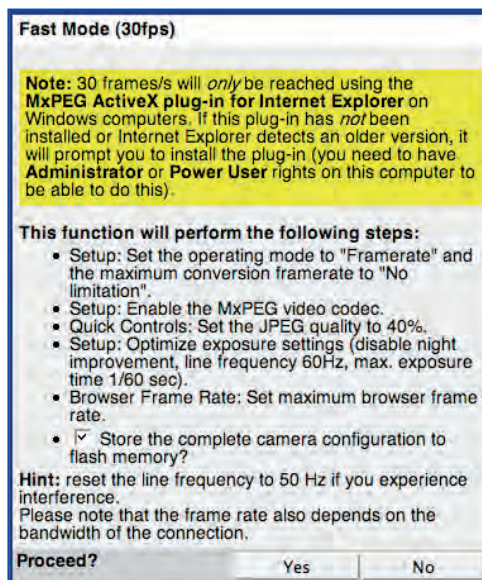

This dialog may contain other steps as shown here, e.g. if the ActiveX plug-in has already been installed.

Expanded softbuttons:

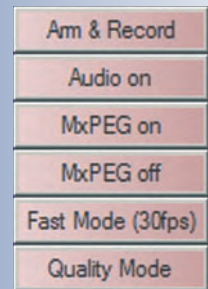

Activate audio:

Sound in the browser only when using Internet Explorer on Windows and with installed **MxPEG ActiveX plug-in**

**Fast video streaming:** Preferably using Internet Explorer on Windows and with installed **MxPEG ActiveX plug-in**





**Quality Mode:**

Optimizes the display in the browser to obtain the best image quality

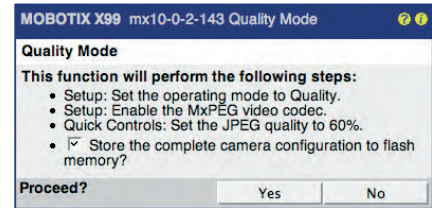
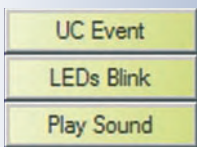

- **Quality Mode:** This button opens the **Quality Mode** dialog. Clicking on the **Yes** button will set the parameters that are required to obtain the best possible image quality while showing the video in the browser window using a medium to fast frame rate. You should select this setting if image quality is more important than a high frame rate.

**Action Softbuttons:****Action Softbuttons**

- **UC Event:** This predefined softbutton uses the **User Click (UC)** event to trigger the storage of an image or video clip. The stored images can then be played back in the Playback screen. Make sure that the **User Click (UC)** event is activated in **Setup Menu > Event Settings**; the camera displays the **UC** event symbol in the bottom left corner of the live image.

This softbutton is perfectly suited to test the camera recording or for manually storing an event image or video clip. If recording has been configured properly, the camera will increment the event counter in the bottom left corner of the live image.

- **LEDs Blink:** This button will let the camera LEDs blink several times at one-second intervals.

This feature can help identifying the camera of a large installation currently shown in the browser, e.g. if it is to be repositioned.

Note that LEDs need to be activated (**Admin Menu > LED Setup**).

- **Play Sound:** This button will play back the default voice message on the speaker of the MOBOTIX camera ("*This is your MOBOTIX camera calling*")

Using this button can also help identifying the camera of a large installation currently shown in the browser, e.g. if it is to be repositioned.

Make sure that the speaker is activated in the **Admin Menu > Loudspeaker and Microphone** dialog.

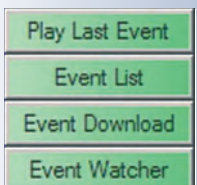
**Event Softbuttons:****Event Softbuttons**

- **Play Last Event:** This button activates the **Playback** screen and automatically plays back the last event video clip the camera recorded.



- Event List:** This button opens the **Event List** dialog. The dialog displays the last twenty events and other information, e.g. total events stored, storage space used internally or on the file server. Clicking a sequence number will show the corresponding video clip on the Player screen. To find the events that occurred around a specific point in time, simply enter the desired date and time and click the **Search** button.

For additional information on this topic, see section 4.4.4, *Image Search Using Date & Time*.

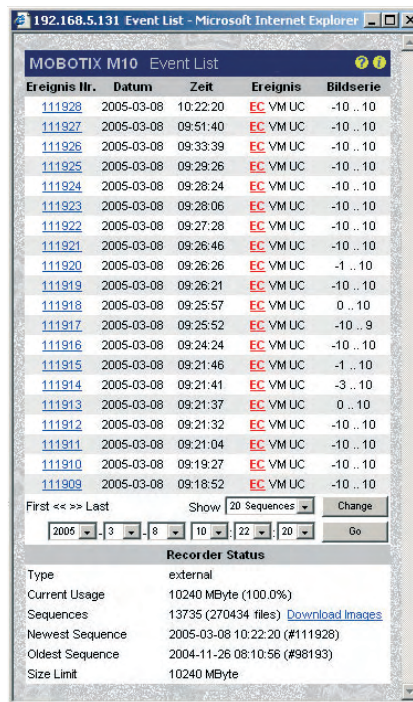

**Event list:**

Event information, searching for events, finding events around a certain point in time

- Event Download:** This button opens the **Download** dialog, which allows downloading all event images/video clips or those within the specified time frame as one TAR archive file or one MxPEG streaming file. The TAR file also contains an HTML index file that can play back the image sequences in the browser, independent of the MOBOTIX camera.

For additional information on this topic, see section 4.4.5, *Archiving*.

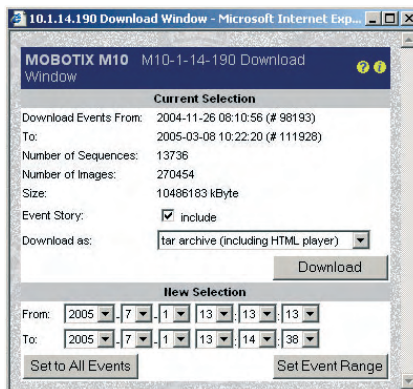

**Downloading events:**

Download all events or the events within a specific date/time range

- Event Watcher:** This button opens the **Event Watcher** Dialog, which shows the last event image and the corresponding information. The event is highlighted in red (*An event has occurred!*), as long as the user has not clicked on the **Acknowledge** link. This feature can be used to acknowledge the alarms, if **MxViewer** cannot be used (see section 4.10.4, *MxViewer*).



**Event Watcher:**

Visual warning and alarm acknowledgement on computers, which cannot run MxViewer

Zoom softbuttons:

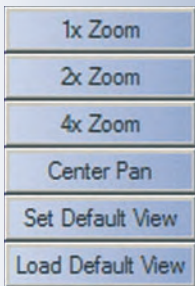

**Zoom feature:**

- Click on the desired spot in the Live image
- Click on the Zoom button (1x, 2x, 4x)

### Zoom Softbuttons

- **1x Zoom, 2x Zoom and 4x Zoom:** The **1x Zoom, 2x Zoom** and **4x Zoom** buttons allow zooming into or out of the image with 2x and 4x enlargement. Zooming is handled completely by the camera software. When used on a MOBOTIX Dual camera with wide-angle and tele lenses, the range of focal lengths available covers 38 mm to about 540 mm (compared to 35mm camera).

In zoom levels 2x and 4x, clicking with the mouse near the borders of the image will move the image within the standard image in that direction (panning). Clicking on **Set Default View** will save the current view; clicking **Load Default View** will restore the view, even when a different zoom level or panning position had been set in the meantime. The **Center Pan** button centers the zoomed view.

These functions are also available from the **Zoom Control Quick Control** (see also *Quick Controls* in the next section).

#### Notes

Some browsers do not properly show the colors of the **softbuttons of the browser interface** (e.g. Safari or Camino on Mac OS X). Firefox, Mozilla and Internet Explorer support the colored softbuttons. In order to display the button colors in Internet Explorer on Windows XP, you need to deactivate the visual effects in the **enhanced Internet options** of Internet Explorer. Section 4.8, *Browser Settings (Colored Buttons)*, contains more information on this topic.

### Quick Controls

Using the **Quick Controls** above the live image, you can set the most important image parameters of the MOBOTIX camera. These settings can also be changed in the Setup Menu.

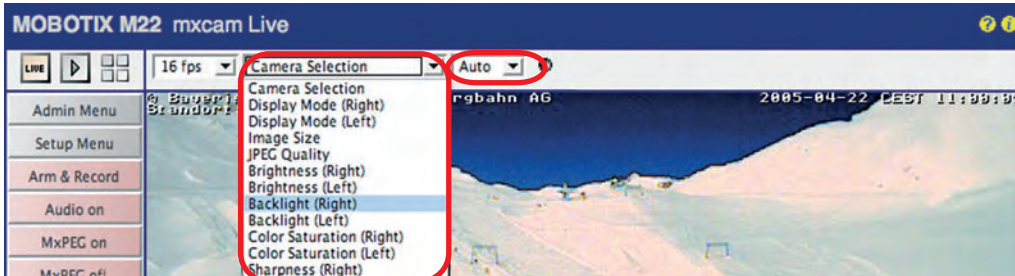

Quick Controls provide fast access to often-used image settings

### Browser frame rate

Use this dropdown list to set the rate for updating the live image in the browser. Note that this setting does not have any influence on the internal image conversion and storage rates (internal or external ring buffer).

### Quick Controls, image settings

These controls comprise the most important image settings. Select the setting you would like to change in the left pull-down menu (e.g. *Camera Selection* on Dual cameras), then change the parameter in the **Set Quick Control value** dropdown list (e.g. *Right, Left, Both, RiL, LiR, Auto*).

The Quick Controls also allow setting the desired values for resolution and display mode, JPEG quality, brightness, backlight, color saturation, exposure windows, zoom control and the browser mode (server push, JScript, Java, ActiveX).

Use the **Manage Settings** item to store the current settings in the Flash memory (*Store Complete Configuration*), to load the factory defaults (*Load Image Factory Defaults*) or to restore the settings last stored to flash memory (*Restore Image Settings*).

For additional information on this topic, see sections 4.3.2, *Image Settings*, and 5.5, *Image Controls*.

#### Note

If you have changed image settings using the Quick Controls, you should also save the changes permanently to the MOBOTIX camera's flash so that the new settings are reloaded after the next reboot (Quick Control **Manage Settings > Store Complete Configuration**). Make sure that you are a member of the **admins** group to execute this function.

**Deactivating** Quick Controls: Admin Menu > Language and Entry Page

### Elements Displayed in the Live Image: Video Motion Detection, Logos

The dotted rectangles in the live image show the **video motion detection windows**. The MOBOTIX camera automatically stores images or video clips if one or more motion detection windows detect a change within the window. If a video motion window detects movement, its frame turns red and it triggers an event.

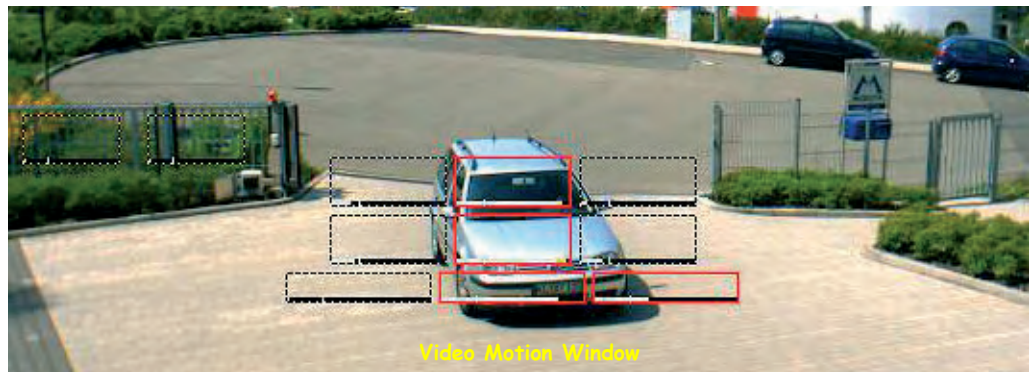

Rather set **several small** Video Motion windows than one or two large ones

#### Logo features:

- Animated
- Transparent
- Freestyle

The camera can also display **Logos** within the live image; these logos may be partially transparent (watermark) and have transparent areas. On top, the camera can rotate several logos and can even play simple animations (**Admin Menu > Logo Profiles**). The graphic files of the logos can be stored in the camera or can be retrieved automatically from external web or FTP servers (**Admin Menu > Manage Image Files**).



### 4.3.2 Image Settings

Use the following Quick Controls for easily setting the most important image parameters:

- **Browser frame rate:** Use this dropdown list to set the rate for updating the live image in the browser. Note that this setting does not have any influence on the internal image conversion and storage rates (internal or external ring buffer).
- **Camera Selection:** Select the sensor (left or right) to be used for the live image if your camera is a dual lens model. Selecting the *Both* option on a Dual model will create a side-by-side image from both image sensors. The *RiL* option displays a miniature version of the right sensor within the image of the left sensor. *LiR* displays a miniature version of the left sensor within the image of the right sensor.

Selecting the *Auto* setting in a MOBOTIX **Night model** causes the camera to automatically switch from the right (color) to the left sensor (B/W) when the illumination falls below the value set for **Camera Night Switch (DY/NI)**. In a

Kameramodell	X	-
X	-	-
X	-	-
-	X	X
-	X	X

#### Camera Selection:

- Right
- Left
- Both
- RiL
- LiR
- Auto



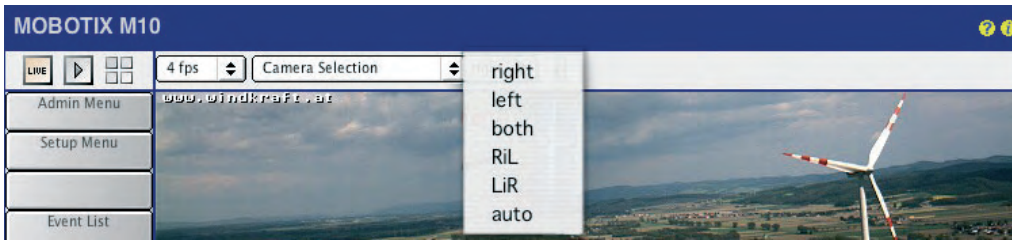

MOBOTIX **Dual model**, combining the *Auto* option with a Time Table profile will let the camera switch sensors automatically at the preset times. When the Time Table profile is active, the camera uses the right sensor; otherwise, the left sensor will be used. For additional information on this topic, see chapter 7.8.6, *Time Tables*.

- **Display Mode:** This Quick Control is preset to *Full Image*; selecting the *EiP* option (Event in Picture) will show the last event as a small image in the bottom right corner of the live image. The *PiZ* (Picture in Zoom) option will show the full image as a small image in the bottom right corner of the zoomed image (2x, 4x).
- **Resolution:** This control sets the image size of the live image. You can choose from the following resolutions: *Mega (1280x960)*, *VGA (640x480)*, *CIF (320x240)*, *PDA (160x120)*, *D-1 PAL (768x576)* and *Custom Size*.
- **JPEG Quality, Brightness, Backlight, Color Saturation, Sharpness:** Using these controls will change the camera's live image immediately, allowing you to see the result on the spot.
- **Exposure Windows:** Use this control to set the predefined exposure measurement windows. The *All* option (default setting) uses the entire image area to determine the correct exposure. The *Hide Windows/Show Windows* options allow controlling if the measurement windows are displayed in the live image (green frames). The *Extra* option uses the custom exposure window. For additional information on this topic, see section 5.7.6, *Exposure Windows* and the following sections.
- **Zoom Control:** This control allows setting the desired zoom factor of the live image (*1x Zoom*, *2x Zoom* and *4x Zoom*). A zoomed (and maybe also panned) image section can be stored using the *Set Default View* option. Use the *Load Default View* option to move the visible image area to the same position. The *Center Pan* button centers the zoomed view.
- **Browser:** Use this Quick Control to set the operating mode for showing the live image in the browser window. For additional information on this topic, see the following section 4.3.3, *Browser Settings, Operating Mode*.
- **Manage Settings:** Among other functions, this control allows storing the current settings in the permanent (Flash) memory of the camera. For additional information on this topic, see section 4.3.4, *Saving the Settings*.

For additional information on the image settings, see section 5.5.2, *General Image Settings*.

Night models automatically switch between day and night lenses!





### 4.3.3 Browser Settings, Operating Mode

The maximum frame rate that can be displayed by the browser is dependent on several factors. Depending on the computer's performance and the operating system, the one or the other operating mode can lead to improved results and higher frame rates in the browser. Set the desired operating mode using the **Image Settings > Browser** quick control.

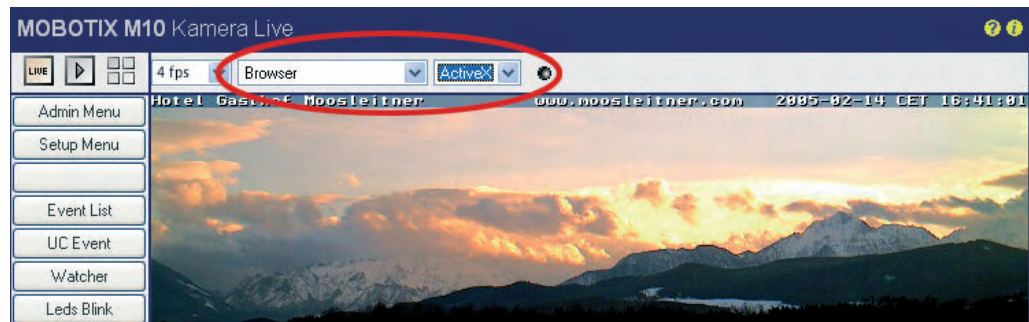

The following **operating modes** are available:

- **Server Push**
- **JScript**
- **Java**
- **ActiveX** (only available for Internet Explorer on Windows computers)

By factory default, the camera uses either **Server Push** or **JScript** (depending on the browser and the operating system).

#### Server Push, JScript

**Server Push** has many advantages over **JScript**, but is not supported by all browsers on all operating systems. When using *Server Push*, **the MOBOTIX camera itself sends (pushes) new images to the browser**, while *JScript* uses JavaScript code and instructs the browser to **pull new images from the MOBOTIX camera**.

#### Java

The **Java** operating mode can be used if problems occur with all other operating modes. In practice, you should never have to select this mode.

#### ActiveX

This is the ideal operating mode for the MOBOTIX camera. However, it only runs in Internet Explorer on Windows computers. **ActiveX** uses an image control developed by MOBOTIX that delivers **high frame rates** when viewing a MOBOTIX camera—either in the browser window or in customized computer programs. The ActiveX plug-in is stored directly in the MOBOTIX camera and will be installed automatically when you select the *ActiveX* operating mode for the first time (provided you agree to its installation). Once the ActiveX plug-in has been installed on the computer, this operating mode can be used with any MOBOTIX camera and this computer without having to install the plug-in again. **The ActiveX operating mode can**

**Server Push** => fast image display for Mozilla, Firefox, and Netscape browsers

**ActiveX** => Audio in Internet Explorer

also transmit the sound from the camera's microphone to the browser (see also section 4.3.5, *JPEG, MxPEG and Audio*).

#### Note

In order to **install the ActiveX plug-in**, you need to have administrator or power user rights under Windows (from version 2000) and you need to agree to the installation. Depending on your settings, you may have to add the IP address of the camera to the list of trusted sites in Internet Explorer (**Tools > Internet Options > Security > Trusted Sites**)!

If you cannot use the ActiveX plug-in, it is recommended to keep the operating mode that the camera automatically selected (Server Push or JScript). For additional information on this topic, see section 4.10, *Fast Video Streaming*.

#### 4.3.4 Saving the Settings

If you would like to keep changed configuration settings, you should store the new configuration into flash memory. This will guarantee that the new configuration is present even after rebooting the camera. Open the **Image Settings** quick control and select **Manage Settings > Store Complete Configuration** to store the new settings in the permanent flash memory.

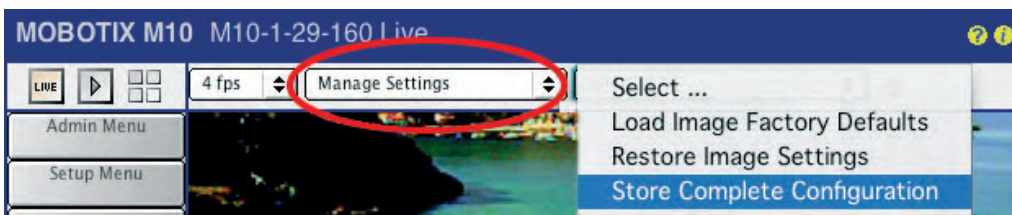

If you are making changes to settings in dialogs of the **Setup Menu** or the **Admin Menu**, you should activate the changes by clicking on **Set**, then store the settings permanently by clicking on **Close** (see figure). Both buttons are located at the bottom of the dialogs.



#### Caution

Closing the dialog box using a key combination (e.g. Alt-F4) or by clicking on the Close symbol in the top right corner of the dialog **will not store the settings permanently**. The settings are lost when rebooting the camera.

Open **Admin Menu > Language and Entry Page** to set the default operating mode. The factory default setting is **Server Push**

Settings are only **temporary**; make sure to store the settings permanently using Quick Controls or **Admin Menu > Store current configuration** into flash memory

MOBOTIX offers two compression standards:

- JPEG
- MxPEG

Simultaneously provides MxPEG and JPEG

#### 4.3.5 JPEG, MxPEG and Audio

The MOBOTIX camera provides two internal compression methods to show the live images in the web browser:

- **JPEG** for creating single images without audio support
- **MxPEG** for fast audio and video streaming

The JPEG operating mode works with almost any graphical browser and **does not require any plug-ins**. Similarly, displaying live video from single JPEG images (**motion JPEG**) with JScript works on almost any JavaScript-capable browser **without** plug-ins.

The highly compressed and fast MxPEG video streaming with sound, on the other hand, requires an ActiveX-capable browser (Internet Explorer on Windows) or the MOBOTIX MxViewer for Windows (see section 4.10, *Fast Video Streaming*).

Every compression method of the camera has certain advantages and disadvantages regarding the frame rate and the quality of the transferred images (see also section 5.5.6, *Compression Format and Image Quality*). It is important to understand, however, that even though the camera runs on MxPEG, you can still view and save JPEG images from a browser without plug-ins.

**The camera will always deliver images to a standard browser without Java or ActiveX plug-ins, independent of the selected compression method.**

The MOBOTIX camera thus has the unique advantage that it can produce a fast live video stream in MxPEG format, but it can also save single images in regular JPEG format for FTP transmission or e-mails. Furthermore, you may set recording to use either MxPEG video format or single JPEG images. Finally, the camera can provide single images or image sequences (motion JPEG) to any standard PC or PDA without any software installation or plug-ins. The MOBOTIX camera can thus provide video streams as MxPEG, JPEG and Motion JPEG **simultaneously**.

Selecting MxPEG, however, has a certain influence on the single images as these are not shot as individual images at a specific point in time, but are combined from several images that have been shot one after another. In principle, MxPEG will only transfer those parts of an image that have been changed compared to the last image, i.e. where movement has been detected.

#### Note

In order to reduce the changes in the images to a minimum, most of the video compression methods use slow exposure control. This is why exposure in single images from an image stream cannot be controlled as well and as quickly as with single JPEG images. When exposure changes quickly, MxPEG video streaming may briefly produce overexposed or underexposed video.

**Note**

For high-quality **web applications**, the camera should thus be set to **JPEG** mode. The camera can still display and record video sequences. It is using the standard motion JPEG process that displays single JPEG image in rapid succession. This, however, reduces the frame rate and requires more storage space.

**Image quality** is directly dependent on the compression level and is displayed as a percentage value. Using a compression of 60% will usually deliver good-quality images for most purposes. Compression below 20% will produce jagged corners in the image; compression above 70% produces images that are hardly different from the original. File size is further dependent on the image contents, i.e. an image with fine details and structure will require more storage space than an image of a country scene with little contrast.

JPEG Quality	160x120 PDA	320x240 CIF	640x480 VGA	1280x960 MEGA
20% (low)	5 kB	10 kB	20 kB	56 kB
40% (medium)	6 kB	15 kB	31 kB	90 kB
60% (high)	8 kB	19 kB	41 kB	136 kB
80% (highest)	10 kB	30 kB	64 kB	213 kB

If **audio** should be obtained from the camera as well, both compression modes are possible. Using MxPEG compression will deliver the highest frame rates and the lowest storage requirements. In order to hear the sound in the browser, you have to select the *ActiveX* operating mode in the quick controls. This operating mode is only available when using Microsoft Internet Explorer under Windows. Note that you have to permit ActiveX in the browser settings. If other browsers or PDAs are used, MxPEG mode will only deliver images, no sound.

When using the ActiveX operating mode in Internet Explorer under MS Windows, you can activate the sound from the camera by **right-clicking directly into the live image in the browser**. Click on **Audio** in the context menu that appears.

The MOBOTIX **MxViewer** for Windows is another possibility to show fast live video simultaneously from many cameras (including sound). It can display around 30 cameras in CIF format (320x240) with 30 frames per second on a standard PC (P4 with 3.0 GHz). Download the newest version of MxViewer free-of-charge from the MOBOTIX website. Section 4.3.6, *Background Information on JPEG, MxPEG and Audio*, will give a more detailed overview of the compression methods.

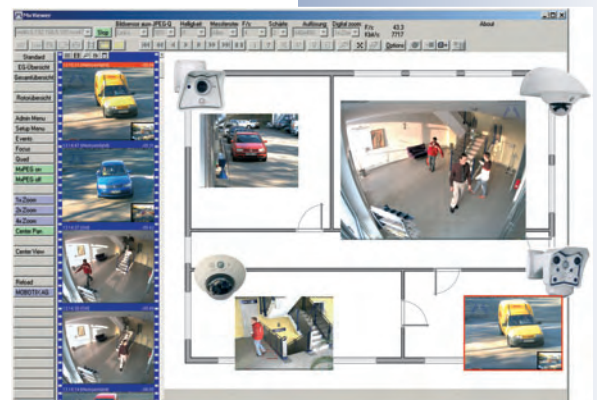

Web applications => JPEG image mode

Fast video streaming: ActiveX operating mode uses MxPEG video compression

Default setting: 60%



**Audio in the Browser?**  
Browser > ActiveX, then right-click in the live image > Audio



### 4.3.6 Background Information on JPEG, MxPEG and Audio

An uncompressed mega pixel image (e.g. as BMP file) would require about 4 MB storage space and would be much too large for efficient storage and transmission. Even on a 100 Mbps network, transferring the file would take about 1/2 second. This means that the image data has to be compressed already in the camera. Several possibilities can be used for this purpose:

#### JPEG

The most common method for compressing single images is **JPEG compression**. This compression method reduces the file size (depending on the quality setting) from 1/20th to 1/50th of its original size.

#### Motion JPEG

If the single images are shown in rapid succession, they appear as live video if the frame rate is 12 frames per second or higher. This process is called **Motion JPEG** since the individual images are JPEG-encoded images.

#### MPEG

Usually, the changes between two images are minor, i.e. many areas of the images are retransmitted, although nothing has changed. This has led to the development of video encoding schemes such as **MPEG**, since it eliminates (redundant) retransmission of identical image areas.

Motion JPEG and MPEG, however, have distinct disadvantages for live cameras. They have been developed for compressing movies but are not optimized for live cameras. How long it takes to encode a movie for a DVD is of no importance – image quality and level of compression are the key factors. A live camera, on the other hand, needs to show the scene on a monitor as quickly as possible (*scene-to-screen* time). The second problem of regular encoding schemes such as MPEG is that moving objects are encoded with lower quality and resolution, since the human eye cannot recognize details of a moving car in a video sequence, for example. For security purposes, however, the moving objects are the most important ones and they have to be transferred to the monitor in good quality and as quickly as possible.



**MxPEG**

In order to circumvent these disadvantages (long delays, low quality of moving objects), MOBOTIX has developed **MxPEG** compression, which is based on individual JPEG images.

In principle, MxPEG will only transfer those parts of an image that have been changed compared to the last image. Improving the compression was not one of the goals. Compared to Motion JPEG, MxPEG reduces the bandwidth requirement by a factor of three to five. Video transmission at 25 fps in CIF format (320x240 pixels) is reduced to only 1 Mbps bandwidth.

MxPEG drastically reduces bandwidth requirements

Realtime audio transmission using MxPEG

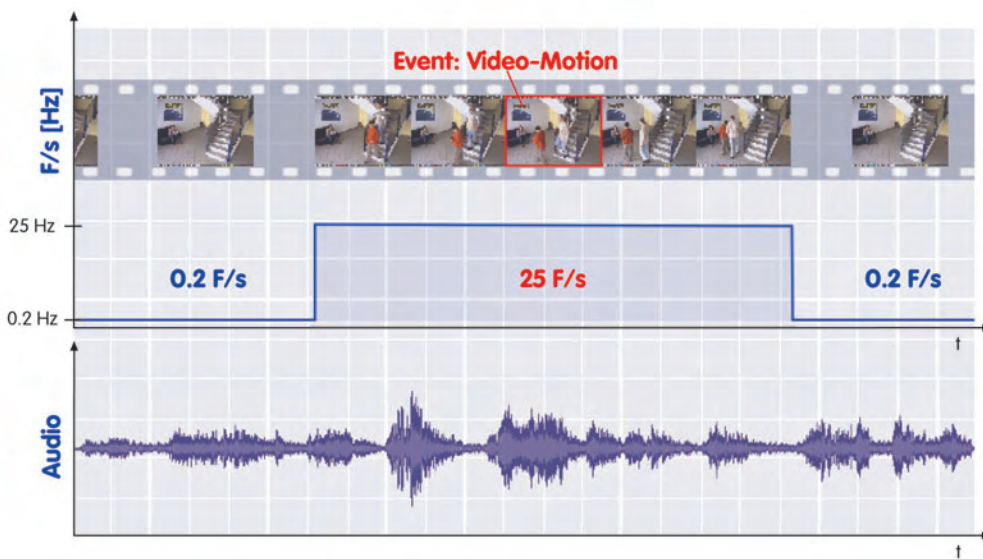

Kameramodell	X	-
...	X	-
...	-	X
...	-	X

Another huge advantage of the MOBOTIX camera with MxPEG video encoding is the audio channel that is transmitted and played back **realtime** independent of the frame rate. This way, the user may adapt the frame rate to the bandwidth of the current connection, while still hearing the full audio channel.

The next advantage is the **multi-channel** capability of the MOBOTIX camera, which means that several users can see video with differing frame rates but with synchronous sound. This becomes a decisive edge if **long-term storage** is involved, since the camera can provide fast live video with 30 fps for a user (and in case of an event), while storing video with 0.2 fps (one image every five seconds) requires very little storage capacity compared to other methods.

MOBOTIX cameras are multi-channel devices



## 4.4 The Playback Screen in the Browser

### 4.4.1 Controls

 The MOBOTIX camera can record image sequences and video clips either triggered by events or continuously. In addition, the camera can save images before and after an event has been triggered.

**Screen selection:**

- Live
- Player
- Multiview



**Softbuttons:**

Admin Menu

Setup Menu (Image, Events)

User Click (UC)

(Buttons can execute almost any camera functions)

Reload

MOBOTIX Homepage

**Player Menu:**

Image control (FF, Rewind, ...) (i) Image info (?) Query Window (time, event)

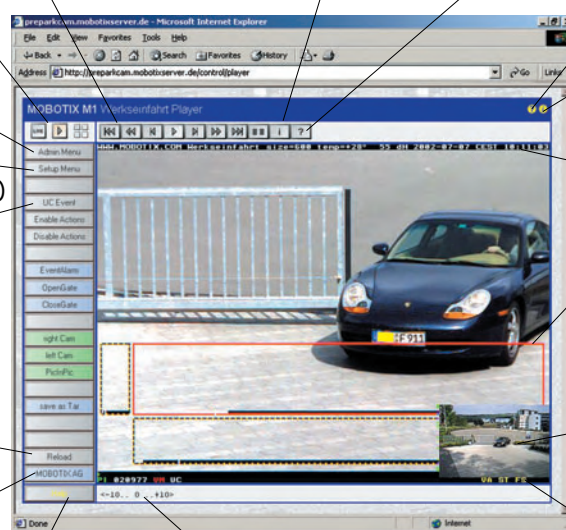

Help pages

Info button

Text display

Video Motion window (freely definable)

Picture in picture (only dual lens models)

Status bar (can be disabled)

**Help pages** **Event Story:** Number of pre- and post-alarm images

Setup Menu > Event Settings to change event settings

You can define several Video Motion windows with different parameters

By factory default, event images are stored automatically in the internal image storage when clicking on the **UC Event** button or when the video motion detection windows (dotted frames on the Live screen) detect movements.

Click on the Player button to open the Playback screen if you would like to play back the recorded images or video clips. Note: It is of no importance if the images reside in the camera's internal storage or on an external file server.

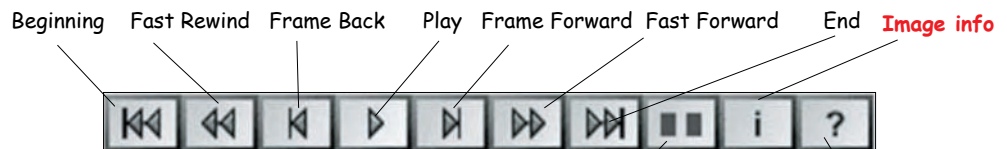

**Player Mode:** Events only / events with stories / single event with story **Image search/Download**

Player controls:  
As simple as a DVD player!

Click on the **Player Mode** button to switch between displaying only event images, event images with story (pre- and post-alarm images) or only one single event with story. When combined with the Fast Forward button, this provides for efficient event search. The Playback screen's footer displays information on the event itself and the event story, i.e. the number of images before and after the event and the current image. For example: for an event with ten images before and six images after, the footer would look like this for the third pre-alarm image: "-10.. -8 ..6".

Clicking on the Image Info  button displays the camera's status at the time when the image had been recorded. This window displays the date and time, camera IP, software version, image and exposure settings and all other sensor data. The data is not stored separately, but is available as JPEG comment in each image.

The Event List (Event List softbutton or  button) shows a link list of the last 20 events that you can browse forward and backward (see section 4.4.4, Image Search Using Date & Time).

Open the **Download** dialog (**Event List** softbutton) to download the recorded video clips as a **compressed tar file** (expand using tar, WinZip, Stuffit, PowerArchiver, etc.) from the camera to your local computer (see section 4.4.5, *Archiving*).

#### Note

Using the Player screen to view event images will not disrupt the recording of new events. However, new event images will only be displayed after the Player window has been reloaded. You can reload the Player window by updating the page in the browser or by clicking on the **Go** button in the Event List.

If the camera's **ring buffer** is full, older events will be deleted to make room for new events. In this case, you will also have to reload the Player screen using one of the methods described above to see the new events.

#### Softbuttons

While the upper part of the softbutton bar is more or less identical to the Live screen (see section 4.3, *The Live Screen*), the lower part features the **Recording off** and **Recording on** softbuttons.

- **Recording off:** Deactivates the recording feature of the camera. The **REC** symbol in the live image will be displayed in gray: **REC**.
- **Recording on:** Activates the recording feature of the camera. The **REC** symbol in the live image will be displayed in yellow: **REC**.

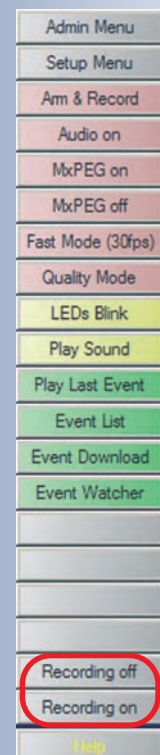
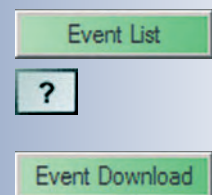



4.4.2 Events and Storage Options

The common way to store images or video clips of an event had been to use the **FTP protocol** to transfer the files to a server (see section 7.8.2, *FTP Profiles*). This transmission protocol should rather be used when saving an image every once in a while and not for storing video sequences in ring buffers; its main purpose is to refresh live images on web sites.

When using FTP, the MOBOTIX camera can automatically create date/time-based folder structures and file names. Moreover, the camera can also send images and video sequences via **e-mail**.

Storing and transmitting images or video via FTP or e-mail can be initiated either

- **event-controlled** or
- **time-controlled**

The events can be triggered by the camera sensors or by external signals, such as the signal input or a network message. The camera's internal sensors include video motion detection, microphone, passive infrared sensor, temperature and other signals (see section 7.6.1, *Event Selection*). Additionally, you can engage periodic recording (**Periodic Event (PE)**) or recording at specific points in time (minute, hour, weekday, month) using **Time Tasks (TT)** (see section 7.9, *Time Tasks*).

Sensor Events
Video Motion window
Passive Infrared sensor
Signal Input
Microphone
Temperature
Illumination

Time-Related Events
Periodic Event
Time Task event
Random event

User Events
User Click (softbutton)
Camera buttons
IR remote control

**Note**

**Setup Menu > Event Settings** contains all sensors of the camera that can be activated, including the corresponding options.

This section and the next are dedicated to one of the most important concepts of the MOBOTIX camera, i.e. **direct ring buffer storage** on a PC or server on the same network. This means that every camera can manage its own storage space in a separate folder on the PC/server **without installing any additional software** on that PC/server. The maximum storage space for the long-term ring buffer storage on the PC/server can be up to several hundred GB and is set in the camera software. The camera automatically deletes old recordings to make room for new video clips or if the allotted life time for a recording has expired. The MOBOTIX camera supports PCs and servers with UNIX, Linux and Windows (from 2000) as well as Mac OS X operating systems (from version 10.3).

Independent of the recording mode chosen, the MOBOTIX camera **always** stores the recorded video clips in the internal ring buffer (see figure *Ring Buffer Synchronization* below). This means that the camera can bridge network failures and main-

Event- or time-controlled recording



No software installation for image archiving on a file server required, since the video management functions are already integrated into the camera

tenance of network components without losing images. It also means that you can replace or restart the recording PC/server without losing recorded video. The MOBOTIX camera thus has a decisive **security advantage** as opposed to the commonly used centralized recording that is controlled by PC software.

Cameras can also monitor each other as well as the recording PC/server and they can send error notifications to the camera administrator using e.g. e-mail or phone calls. Even a total loss of the recording PC/server is not a problem any more as the cameras automatically switch to a backup PC/server (feature currently under development).

The Playback screen allows searching for and displaying the recorded events, independent of where the video clips have been stored (either internally or in a ring buffer on a PC/server). No user interaction is required, regardless of where the images are stored. The administration menu of the MOBOTIX camera contains the **Event Storage** dialog for setting the network address and the maximum storage capacity on the recording PC/server (see chapter 8, *Recording*).

The MOBOTIX camera automatically recognizes and reports **file server outages**

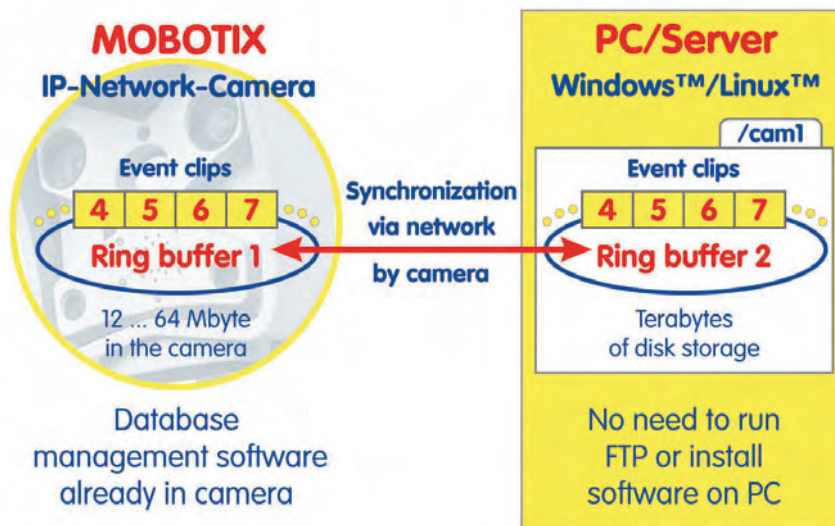

### 4.4.3 Recording Modes

If required, MOBOTIX cameras can control image and video storage using the integrated **weekly time tables** as set in the browser interface of the camera (see section 7.8.6, *Time Tables*). The time tables can also be combined with e.g. a key switch and the camera's signal input. Recording can then be:

- started
- stopped or
- extended (retriggered).

This allows e.g. a door switch to start a recording of predefined length using the camera's signal input, while recording is extended as long as the camera recognizes movement in the image. As an additional feature, the camera can filter the number of events over time, so that an alarm is only triggered, if more than x events occur in the specified time frame. This flexibility for event selection and filtering can reduce the number of false alarms (and recordings) drastically.

Arming can be controlled to the minute using the weekly time table profiles (see section 7.8.6, *Time Tables*). Every weekday can have a different setting with several periods per day in which the camera is armed. On top, MOBOTIX cameras can handle **custom days** for including or excluding freely definable days or vacation times.

The MOBOTIX cameras offer four different recording modes:

- **Snap Shot Recording** with pre- and post-alarm images (JPEG), but without sound
- **Event Recording:** with variable frame rate and sound (MxPEG)
- **Continuous Recording:** with audio and reduced frame rate that is automatically increased to the maximum frame rate on events (MxPEG)
- **History Recording:** recording of additional images at pre-defined intervals (JPEG)

The recording modes are independent of the selected encoding type (JPEG, MxPEG). Using MOBOTIX' own MxPEG encoding, however, will result in the highest frame rates and the lowest storage requirements.

Besides the event-controlled recording, the camera can store **history images** at regular intervals and independent of the other recording options. If required, the image format can be different from the format of the live images. This provides for storing a single megapixel image every 10 minutes parallel to the event-controlled video/audio recording with pre- and post-alarm images in VGA format.

**Snap Shot Recording** will record the event image as a single JPEG image in a separate file. You may set up to 50 pre- and post-alarm images that will also be saved in single JPEG files at a fixed interval (Basic and Web

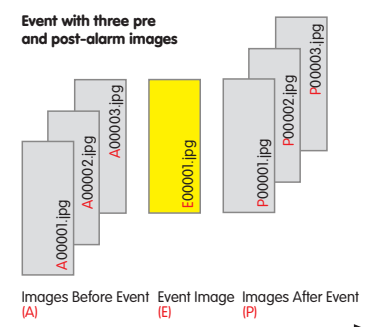

Kameramodal		
X	-	
X	-	
-	X	
-		X

Kameramodal		
X	-	
X	-	
-	X	
-		X

History images!

Single images for high-quality shots and long-term recording with low storage requirements

models: max. 3 pre- and post-alarm images, IT models up to 10 pre- and post-alarm images). These images (files) will be stored in one folder that has the event number as name.

The **advantages of snap shot recording** are the low storage space requirements for the images and the possibility of setting the interval between the pre- and post-alarm images to up to ten minutes. Since the images are stored as individual JPEG files, you may use the integrated playback features of the browser interface to view the recorded images or you can access the files directly on the file server—by using other applications that have been designed for that purpose. On the other hand, snap shot recording has the disadvantage that many events with many pre- and post-alarm images will use more server performance than the two MxPEG-based recording modes (Event and Continuous Recording).

Basic/Web: max. 3 pre- and post-alarm images  
IT: max. 10 pre- and post-alarm images

### Recording Using Integrated Camera Functions

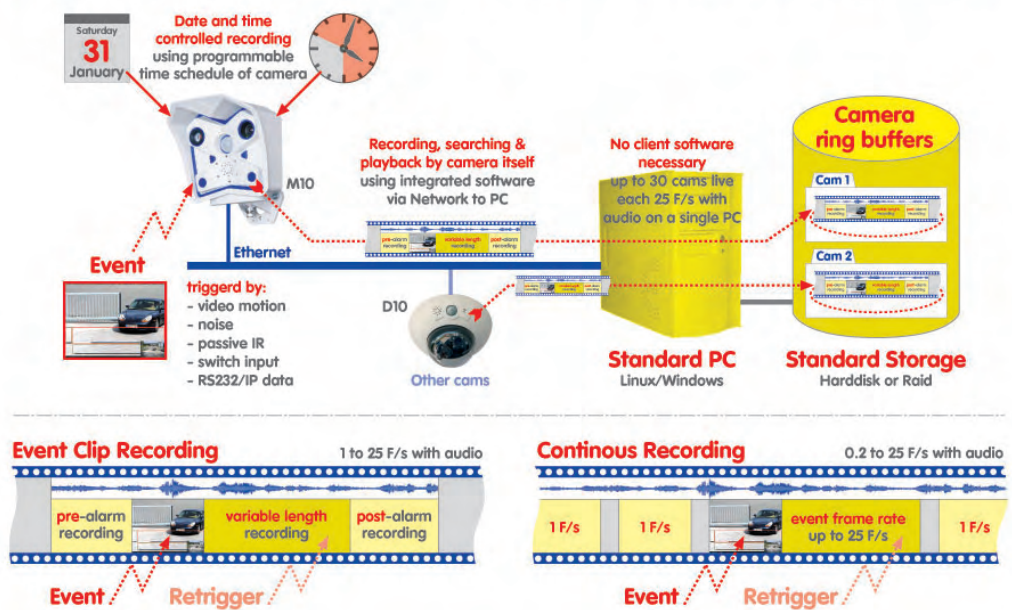

**Event Recording** stores a combined video and audio sequence of **variable length**. The frame rate can be set to a maximum of 30 frames per second. This recording mode is the default mode used in security applications and will only start recording if the camera detects events, such as movements in the camera's video motion windows of the live image. As up to ten seconds of pre-event time can be recorded, the camera can also record the development **leading up to** the event. Independent of the frame rate set for the Live screen, the recording frame rate can be set to meet the application's requirements and the storage space at hand.

Kameramodel	X	-
	X	-
	X	-
	-	X
	-	X

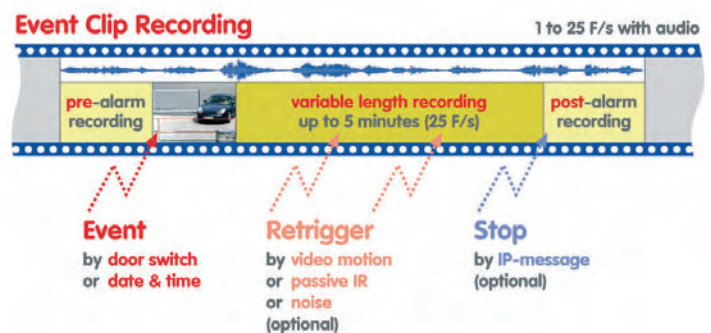

The video sequences are stored on the PC or server as clip files that contain up to ten seconds of video and audio. This approach drastically reduces the number of files as compared to snap shot recording with pre- and post-alarm images. The efficiency of the PC or server used for recording increases by a factor of ten.

Event clips for efficient recording of event images **with audio**





Continuous recording with reduced frame rate and permanent audio recording



**Continuous Recording** allows storing a continuous audio/video stream using a variable frame rate between 0.2 to 30 fps. Moreover, the camera can automatically **increase the frame rate when the camera detects an event**. You could, for example, set continuous recording to one image every five seconds (0.2 fps), and have the camera switch to 30 frames per second for recording once the camera detects an event.

The video stream will be stored in the ring buffer in clip files of up to ten seconds in length. This highly efficient recording mode makes it possible for **30 cameras to record a live video/audio stream with 30 frames per second** on a standard PC (P4 with 3.0 GHz).

If your application requires more cameras, adding more cameras and more servers is easily accomplished. If high-performance server PCs and Raid file systems are used, the number of cameras per server can be further increased. Especially when high frame rates are required, the MOBOTIX approach is clearly superior to the more traditional approach of centralized event detection and storage using a PC application.

#### 4.4.4 Image Search Using Date & Time

The event list (Event List softbutton or [OBJEKT] button) contains a list of the last 20 events recorded by the camera. If you enter a specific date and time in the past and click on the **Search** button, the focus of the event list will be moved to the selected point in time. The event that is closest to the selected point in time is highlighted by a yellow background. The highly efficient binary search algorithm of the MOBOTIX camera results in short response times even when millions of images are stored in an external ring buffer on a PC or server. This is the same for searches conducted over a slow connection (e.g. ISDN) as the camera itself performs the search, not the browser.

#### 4.4.5 Archiving

Clicking on the **Event Download** softbutton or the **Download Images** link in the event list dialog allows downloading the recorded event images and video sequences as a compressed TAR file (expand using tar, WinZip, Stuffit, PowerArchiver, ...) or as MxPEG streaming file from the camera to any storage device. The TAR archive also contains an HTML index file that can play back the image sequences in a browser, independent of the MOBOTIX camera. The recorded images and video sequences can

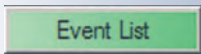
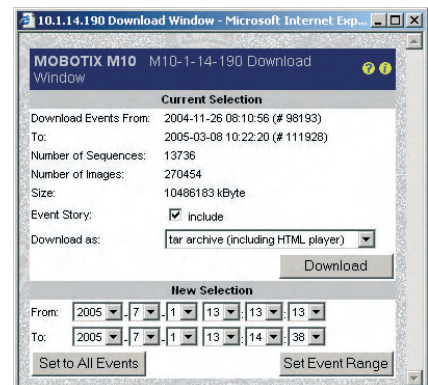

Fast image search using the Event List

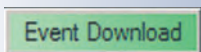

thus be sent easily using e-mail or they can be stored on a CD or other external storage devices. In order to view the recorded event images and image sequences, no application other than a browser is required. Since the images in the compressed tar file are JPEG images, they can be shown or edited using standard applications once they have been decompressed.

## 4.5 The MultiView Screen in the Browser

### 4.5.1 Controls

Using any MOBOTIX camera to display several cameras in one browser is very simple and does not involve any kind of software installation. The camera images can be displayed in sizes of 160x120, 320x240, 640x480 and 1280x960. The number and size of live camera images is only restricted by the screen size and the resolution of the monitor.

**Screen selection:**

- Live
- Player
- Multiview

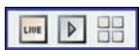

**Softbuttons:**

- Admin Menu
- Setup Menu (Image, Events)
- User Click
- Reload
- MOBOTIX Homepage

**Multi View screen:** can be split freely to display several live cameras and event images (screen shows 4 events and 1 live image)

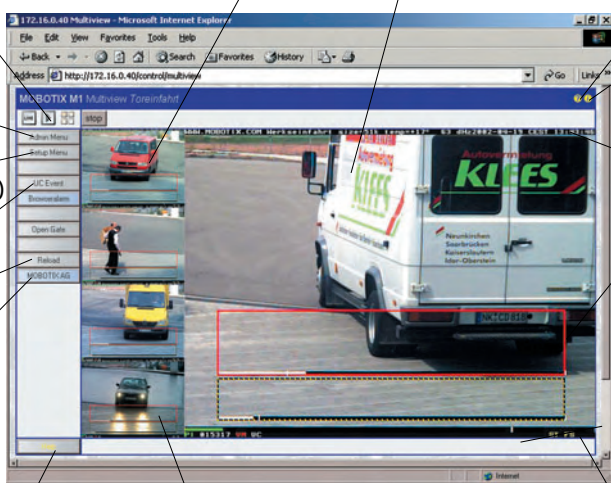

**Help pages** **Event area:** shows the last events (auto zoom when hovering with the mouse)

- Help pages
- Info button
- Text display
- Video motion window for triggering alarms
- Status bar

By factory default, three MultiView screens with different layouts and configurations have been preset (**Events**, **Focus** and **Quad** softbuttons). Click on the corresponding button to open the desired screen.

Besides the existing MultiView screens, you may create your own layouts (see section 4.5.4, *Creating Customized Screens*), complete with an automatically created softbutton for the new MultiView screen. Clicking on one of the MultiView softbuttons thus provides a convenient method for switching between the different MultiView screens.

When switching to the MultiView screen of the camera, the **Events** screen will be loaded automatically (see figure on preceding page). This screen shows the current live image in the right image pane (640 x 480 pixels) and the last four event images on the left side using an image size of 160 x 120 pixels. Move the mouse

To display and extract the contents of the downloaded .tar archive file, use e.g. WinZip, StuffIt or PowerArchiver.

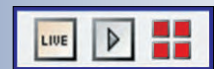

You can define quad views, sequencers or automatic alarm popups with tracking

Use the softbuttons to switch between different MultiView screens

**Shift-click** to customize softbuttons

Switch between several **screens** using softbuttons

**Shift-click** on an event image

Using this list, you can also streamline camera administration, e.g. you can copy definitions (passwords, softbuttons, MultiView screens, ...) from one camera to one or more cameras

over one of the event images to display an enlarged version of the event image (Auto Zoom). Click on one of the event images to open the Playback screen with the corresponding event image in the browser. For each of the image areas on the MultiView screen, you can set how the area should react to mouse-over events, alarms and when clicking on the image (see section 4.5.3, *Configuring Image Areas*).

#### 4.5.2 Defining Cameras

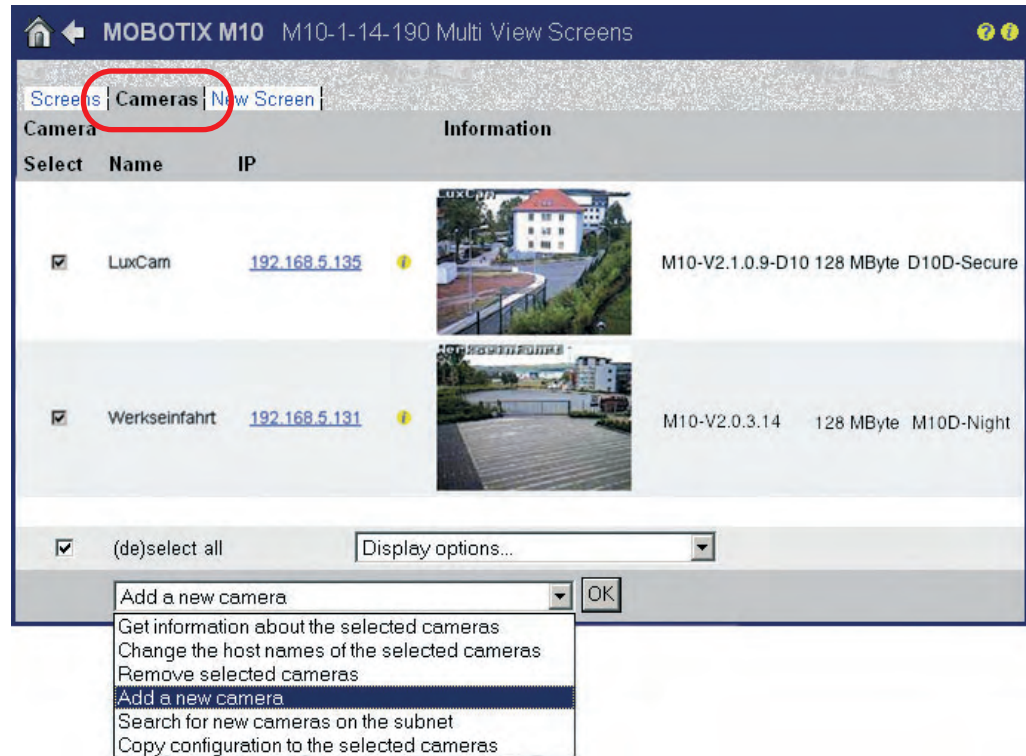

You may select one MOBOTIX camera for each of the image areas of the MultiView screen (see section 4.5.3, *Configuring Image Areas*). Finding other MOBOTIX cameras is easy as the camera can search for other MOBOTIX cameras on the same subnet and can add them automatically to the list of available cameras (**Admin Menu > MultiView Screens > Cameras**, see figure). Select *Search for new cameras on the subnet* and click on **OK** to have the camera search for other MOBOTIX cameras on the subnet and to display them in the camera list. As an alternative, you can enter the IP address of a known MOBOTIX camera by selecting *Add a new camera*, clicking on **OK**, entering the IP address and clicking on **Add**.



## Note

**Camera List:** The list of the cameras found on this subnet is a snapshot of all MOBOTIX cameras that were online when the search was initiated. It is by design that this list is not updated automatically as this would mean unnecessary network traffic and would put extra load on the searching camera. It makes sense to update the list of available cameras before creating a new MultiView configuration or to delete the list of cameras and then have the camera search again for all cameras that are present on the subnet.

**Storing the Configuration:** After you have searched for MOBOTIX cameras on the subnet, you should click the **Set** button. After clicking on the **Close** button, the entire configuration will be stored in the permanent Flash storage of the camera (provided you agree). This will ensure that the camera list is still present after rebooting the camera.

**Important:** The *Search for new cameras on the subnet* option only finds cameras that are on the same subnet as the searching camera. This means that a camera with an IP address of **192.168.0.27** (network mask **255.255.255.0**) will find a camera with an IP address of **192.168.0.58**, but not a camera with an IP address of **192.168.5.58**.

### 4.5.3 Configuring Image Areas

In order to display a camera in a specific image area or to change the display options of a camera, Shift-click the desired image area.

The **Configure MultiView Image Area** dialog opens, allowing you to set the following parameters:

(1) **Select a camera:**

**Camera:** Select a camera (the name shown in the list is the camera name as set in **Admin Menu > Ethernet Interface** or by the Quick Installation wizard). The *localcam* entry corresponds to the current camera. If *localcam* is the only entry in the list, click on the **Define** link and add cameras as described in section 4.5.2, *Defining Cameras*.

You can copy configuration files from one camera to one or more other cameras (see section 5.9.4, *Copying Configuration Files to Other Cameras*)

One camera can automatically find the other MOBOTIX cameras on the subnet

Single image areas can be customized individually!

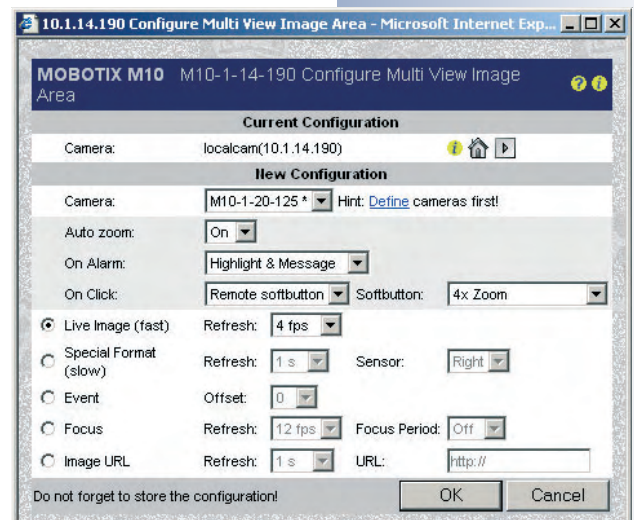



Automatic switching between cameras in case of an alarm (event) or tracking of an event using several cameras

Flexible display options for every image area

## (2) **Set the behavior of an image area:**

**Auto zoom:** If this option is set to *On*, moving your mouse over this image area will automatically enlarge this camera's image.

**On Alarm:** Use this option to set what should happen when the displayed camera detects an event (alarm):

- *Highlight:* The image window will be colored in light red.
- *Message:* A colored browser window with more information will pop up.
- *Focus:* The image from the image area will be shown in a different image area (e.g. enlarged). This requires that one of the image areas has been set as **Focus** area (see below).

**Note:** You may select one of the combinations of *Highlight*, *Message* and *Focus*.

**On Click:** Use this option to define what should happen when you click on the image area:

- *Goto Live Image:* Opens the Live screen of the corresponding camera in the browser window.
- *Goto Player:* Opens the Playback screen of the corresponding camera in the browser window.
- *Remote softbutton:* Executes the softbutton command selected in the **Softbutton** box (e.g. *4x Zoom* activates the 4x soft zoom of the camera, *Quad* activates the **Quad** MultiView screen).

## (3) **Set the display options of an image area:**

- **Live Image (fast):** Shows the current live image of the corresponding camera in the MultiView image area. The **Refresh** parameter is independent of the frame rate set for the Live screen of the camera. If **On Alarm** has been set to *Focus*, the image will also be displayed in the focus area of the MultiView screen (see below).

- **Special Format (slow):** This option selects the image that is to be shown (left or right image sensor for MOBOTIX Dual or Night models) and the frame rate, both independent of any live image settings of the corresponding camera. This setting is named "slow" since the camera has to create additional images with different settings besides the live images and this process requires extra computing time.

- **Event:** Shows one of the last ten events in the image area (0 = last event, 1 = second but last event, ...). This option allows displaying a certain number of events that are always present on the screen (as defined in the **Events** MultiView window).

- Focus:** Apart from image areas that display live and event images (see above), you can define one "focus area" per screen. The focus area can be set to the image of the camera that was last clicked, the latest event image or it can cycle through the images of the other cameras one after another. Usually, the focus area is the large one; all other areas are smaller. The **Events** MultiView screen is a typical example of such a screen definition.

You may also set a separate **Refresh** rate when the live image is displayed in the focus window. If **Focus Period** has been set to *Off*, the corresponding camera images will be shown in the focus window once an event has occurred. If a duration has been set for **Focus Period** (3 s, 5 s, ...), all image areas for which the **On Alarm** parameter has been set to *Focus* will be shown for the specified duration.

- Image URL:** Enter a JPEG image with full path that is to be loaded either from the local subnet or from the Internet using a specific periodic refresh rate. This option allows displaying network cameras or web cams from other manufacturers.

Cycling through a list of cameras for an image area in an endless loop

This option allows displaying network cameras or web cams from other manufacturers

#### 4.5.4 Creating Customized Screens

You can change the parameters of the predefined MultiView screens of the MOBOTIX camera (**Events, Focus, Quad**) at any time or you can create new screens for your requirements (**Admin Menu > MultiView Screens > New Screen**, see figure). For adding new screens, several predefined layouts are available.

Besides entering the name and selecting the desired layout for the new screen, you may also set the new MultiView screen as Default screen (MultiView always shows this screen when opened) and you can let the camera automatically create a new softbutton for this screen.

The **Screens** tab contains a list of all defined MultiView screens. Use this tab to manage, open, delete or rename the defined screens and to set the default screen.

In order to assign MOBOTIX cameras to individual image areas of the MultiView screen, open the corresponding screen and proceed as described in section 4.5.3, *Configuring Image Areas*.

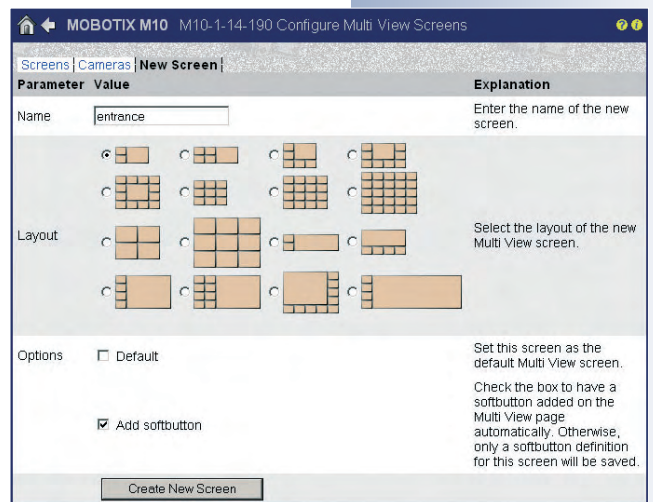

Note

By editing the configuration file, you can create customized layouts that are not present in the factory configuration. Please send a message to your MOBOTIX Support team (intl-support@mobotix.com) if you would like to know how to create individual MultiView layouts.

Creating custom Multi-View layouts

Live and event images on the PDA/mobile

<http://10.1.0.99/pda>

**Caution:** Images on the PDA Live screen are updated automatically if the PDA browser supports JavaScript or manually by repeatedly clicking on the Live control

## 4.6 PDA Screen

### 4.6.1 Accessing the PDA Screen

The PDA screen is a special screen of the MOBOTIX camera that is optimized for PDAs and smart phones that are able to display the event images of the MOBOTIX camera on their displays. Moreover, the PDA screen provides functions and dialogs that have been designed especially for these devices. This means that you can open a list of all events in the PDA, and that you can view and download the event images.



Entering the URL <http://x.x.x.x/pda> in the PDA browser allows accessing the PDA page directly, but it is also possible to set the PDA page as entry page (**Admin Menu > Language and Entry Page**). To access the administration menu, enter the following URL: <http://x.x.x.x/admin>.

#### Accessing the PDA screen without the button bar:









- <http://x.x.x.x/pda/s> PDA screen 160x120 pixels
- <http://x.x.x.x/pda/m> PDA screen 320x240 pixels
- <http://x.x.x.x/pda/l> PDA screen 640x480 pixels

### 4.6.2 Controls and Event List

The PDA screen of the MOBOTIX camera contains the current live image, a title bar on top and a button bar at the bottom of the screen.

The title bar shows the name of the MOBOTIX camera, date and time, the current JPEG quality and two buttons to increase/decrease JPEG quality. When working with low bandwidths or to save costs when using volume-based transmission (e.g. via GSM or GPRS), this setting may be used to reduce the data volume.

The button bar (see figure) contains the following **controls**:

-  **Live:** The Live PDA screen displays the current image of the MOBOTIX camera. To see a new image, click on the **Live** button.
-  **Player:** Use the Player button to view the events stored in the internal or the external image storage (file server) of the camera. Click on the image to display it in its original size.
-  **Event list:** The event list displays a list of the latest stored events.
-  **Query:** Select a date and time to show and click on the > button. You will receive a list of events with all events before and after the selected date and time.
-  **Softbuttons:** Select one of the camera functions of the **Softbuttons** PDA dialog and click **OK** to execute the function.
-  **Size:** This button displays the **default resolution of 320x240 pixels**. The following resolutions are also available: 160x120, 640x480.
-  **Switch Lens:** Click on this button to switch lenses. This button is not available on MOBOTIX camera models with only one lens (Mono models).
-  **User Click:** Triggers the **User Click (UC)** event of the camera.
-  **Camera Information:** Displays information on the hardware, software and the most important settings of the camera in a format that is suitable for PDAs.

#### Note

JavaScript-enabled PDA browsers will update the live image automatically if the links **pda/s**, **pda/m** and **pda/l** are used.

- **http://x.x.x.x/pda/s** PDA screen 160x120 pixels
- **http://x.x.x.x/pda/m** PDA screen 320x240 pixels
- **http://x.x.x.x/pda/l** PDA screen 640x480 pixels

To see **a new image in the PDA screen**, click the **Live** button repeatedly.

Image is updated using the **Live** button



### 4.7 Guest Screen

The Guest screen of the camera shows the live image of the MOBOTIX camera with a minimum number of controls.

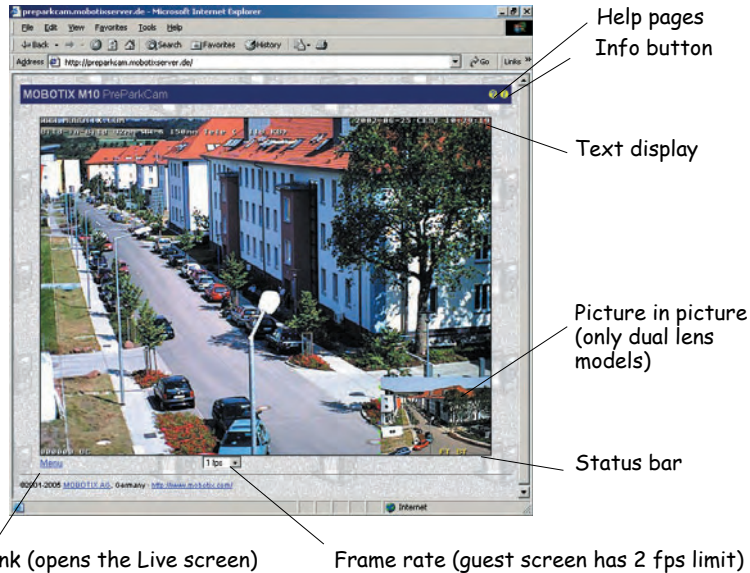

Guest screen with reduced image rate

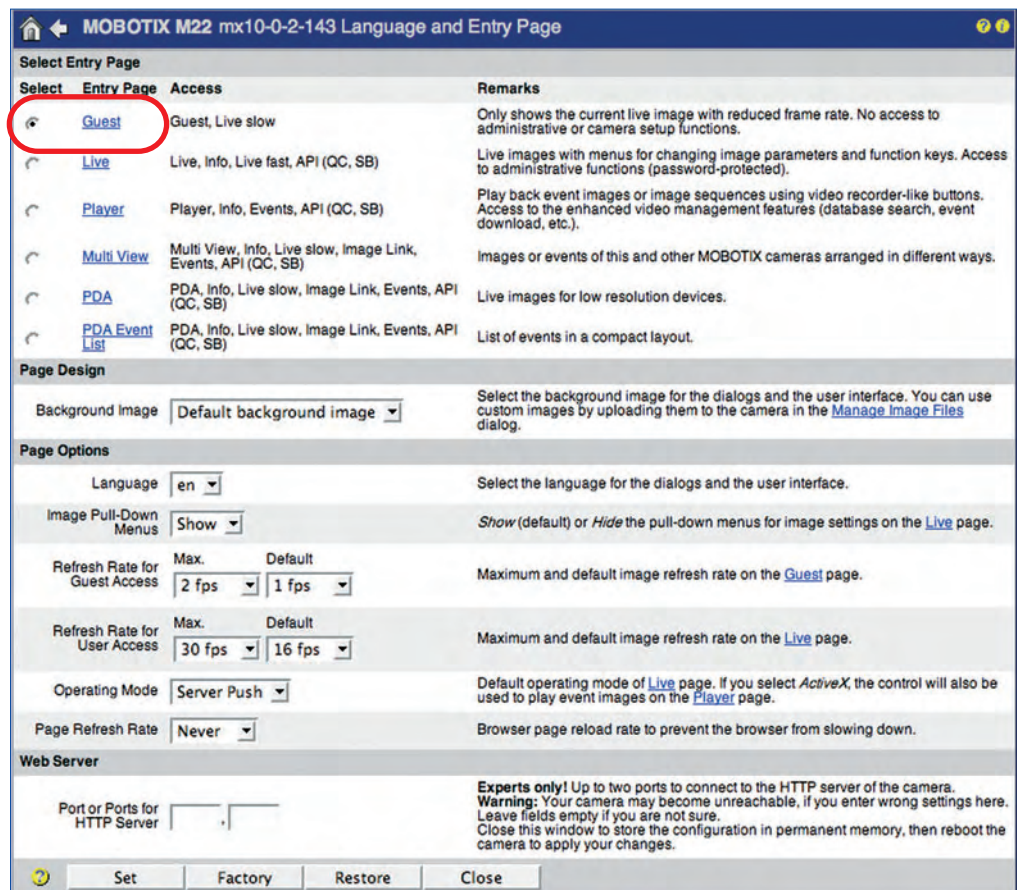

To access the Guest screen directly, enter the following URL: **http://x.x.x.x/cgi-bin/guestimage.html**. The Guest screen can be selected as default start screen for the camera (**Admin Menu > Language and Entry Page**).

Setting the Guest screen as entry page



The  button in the top right corner accesses the camera's online help, the  button opens the Camera Status dialog. Click on the **Menu** link below the live image to access the Live screen of the MOBOTIX camera.

The only control available on the Guest screen allows setting the frame rate. Open **Admin Menu > Language and Entry Page** to set the maximum and the default frame rate. Setting a lower maximum frame rate allows maintaining a reasonable level of bandwidth usage in the local network. This is especially important if many cameras and many users are involved.

One of the main advantages of the Guest screen is that you can make the live images of the MOBOTIX camera available to certain users, but they cannot manipulate the camera settings in any way. The **Admin Menu > Users and Passwords** and **Admin Menu > Group Access Control List (ACL)** dialogs allow setting individual access rights of specific users and user groups. For additional information on this topic, see section 5.4.1, *Users, User Groups, Passwords, Supervisor Mode*.

#### Note

For security reasons the MOBOTIX camera does not support uploading customized pages. If you would like to accomplish this anyway, you can achieve this with fairly little programming in a separate HTML page combined with some simple JavaScript code. Your MOBOTIX Support team will send you the corresponding JavaScript or ObjectID code for the ActiveX plug-in upon request:  
([intl-support@mobotix.com](mailto:intl-support@mobotix.com)).

Click the **Menu** link to open the Live screen

Change the standard HTTP port in the Admin Menu to protect the camera from unauthorized access

## 4.8 Browser Settings

Current browsers with activated **JavaScript** (Internet Explorer, Netscape, Mozilla, Firefox, Safari, Konqueror, Opera, Camino, etc.) can show the camera's live images with their standard settings. Text-based browsers (e.g. Lynx) cannot display the user interface and are *not* suitable for operating the camera.

A restrictive configuration of a browser or operating system, however, will prevent certain camera features from working properly and may even make working with the camera impossible. This may also be caused by the selected security or browser cache settings or if proxy servers are used.

### You may experience problems in the following areas:

- **Popup Blocker:** **Popups** are windows that display (mostly unwanted) windows without user interaction (in this case, the MOBOTIX camera creates these windows). While active popup blockers make sense when surfing websites on the Internet, they may prevent individual windows from being displayed when used together with a MOBOTIX camera. The MOBOTIX camera creates individual popup windows in order to display detailed information (e.g. the *Network Test Log* window, see section 5.3, *Connection Test*). Since popup blockers are available not only in browsers but in plug-ins as well (e.g. in the Google toolbar), this subject is of major interest.

To circumvent this problem, you can either deactivate popup blockers in general or you can enter the respective camera IP addresses or address ranges in the **exception lists** of the popup blocker or browser (recommended).

- **Browser Cache:** Browsers store viewed pages locally in the **cache** of your computer. This minimizes the transfer time and reduces bandwidth. There is, however, a chance that you may see outdated information. When updating the camera software, this will definitely cause negative side effects.

To avoid this, it is recommended that you configure your browser cache so that the cache contents are **automatically** compared to the contents of the website every time you access a website. While the software is updated, it is recommended that you either deactivate the cache or set it to its minimum size.

- **Proxy Server:** Similar to browser caches, **proxy servers** (predominantly used in larger networks) are used to temporarily store website files so that these files can be sent to a browser without having to download them again. When updating the camera software, for example, proxy servers can block the entire process or parts of it.

If a proxy server is used in your local network, it is strongly recommended that you enter the cameras' IP addresses or a respective camera subnet as **proxy exceptions** (see chapter 6, *Software Updates*).

Caution: Deactivate popup blockers!

Set the browser cache to automatic updating!

Add the camera to the proxy exceptions!

- **Security Settings:** Restrictive browser **security settings** may complicate or even prevent using the browser-based user interface of the MOBOTIX camera. Make sure that **JavaScript** or **Active Scripting** (whichever is appropriate) are activated. It is recommended to add the camera IP addresses to the list of trusted sites. This is especially important if you intend to install the MxPEG ActiveX plug-in of older camera software versions for fast video and audio streaming (see section 4.3.3, *Browser Settings, Operating Mode*).
- **Colored Buttons:** Under Windows XP, the **buttons in the browser view** are not shown colored since the Internet Explorer by default uses the visual effects of the operating system for the browser buttons. In order to display button colors, you can deactivate the use of these visual effects in the **Internet options** of the Internet Explorer.

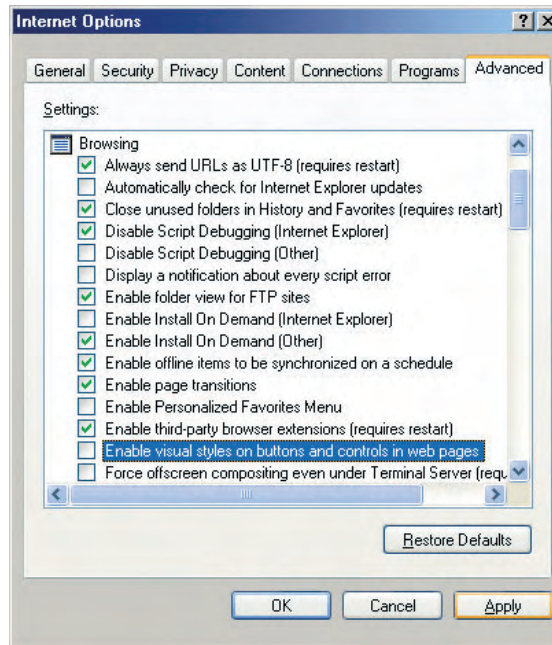

Activate JavaScript/  
ActiveScripting!

Activating the colored  
softbuttons in Internet  
Explorer

For more information on finding and solving errors, read chapter 12, *Troubleshooting*.



Softbuttons are freely configurable!

Other local or global web sites can be added to the menu

Also used to switch other devices using the camera's serial interface (heating system, phone system, etc.)

## 4.9 Configuring the Softbuttons



The softbuttons on the left-hand side of the Live, Player and MultiView screens execute a number of predefined camera functions. You may assign other functions and freely change the color and order of the buttons.

Apart from executing most common camera features, such as switching between different MultiView screens, you may also open documents on the LAN or on the Internet. You may thus display any web page from the Internet or you could open an Emergency Procedures document (HTML, PDF, AVI, etc.) from a server or the local PC.

Softbuttons are also perfectly suited to control e.g. **pan/tilt heads** that are connected to the serial interface of the camera. This is accomplished by assigning the control commands to the corresponding button, which in turn sends the command to the camera's serial interface when clicked. Several pan/tilt head manufacturers deliver a configuration file for the MOBOTIX camera. After loading this configuration file (**Admin Menu > Load ...**), the softbuttons are preset with the appropriate commands.

### Note

Under Windows XP, the **buttons in the browser view** are not shown colored since the Internet Explorer by default uses the visual effects of the operating system for the browser buttons. In order to display colored buttons, you can deactivate the use of these visual effects in the **Internet options** of Internet Explorer (see section 4.8, *Browser Settings*). Depending on the operating system, some browsers do not show the colors of the softbuttons at all (e.g. Safari or Camino on Mac OS X).

### 4.9.1 Configuring a Softbutton

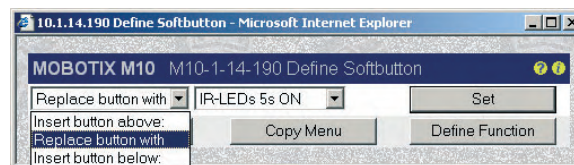

Configuring the softbuttons is quite simple using the corresponding dialog. **Shift-click an existing softbutton** to open the **Define Softbutton** dialog. This dialog allows

deleting, replacing or re-assigning the softbutton. You can also use this dialog to create new softbuttons above or below the softbutton you clicked in the beginning.

Click on **Set** to save the changes and to reload the screen with the changed softbutton layout. Click on **Default Menu** to reset the softbuttons of all camera screens (Live, Player and MultiView) to the factory settings. Click on **Copy Menu** to copy the current softbutton configuration to all other screens. Click on **Define Function** to open the **Configure Softbuttons** dialog.

Requires access rights of the *admins* group

Click on **Set** to edit a button

### 4.9.2 Managing Softbutton Functions

The **Admin Menu > Configure Softbuttons** dialog lists all functions that are used in conjunction with a softbutton. Assigning such a function to a softbutton is accomplished using a Shift-click on a softbutton, as described above.

The **Name** field contains the caption of the softbutton. The **Color** selection box allows setting a background color for a button (Grey, Green, Red, Blue or Yellow). The **Function** selection box sets the function of the softbutton. Numerous functions have been predefined as per factory settings (e.g. opening the Setup or the Admin menu, FTP, e-mail, LEDs, Reboot, ...) or are added by other dialogs. *MV: Events* for instance opens the **Events** MultiView screen.

You may select the name and one of five colors for a softbutton

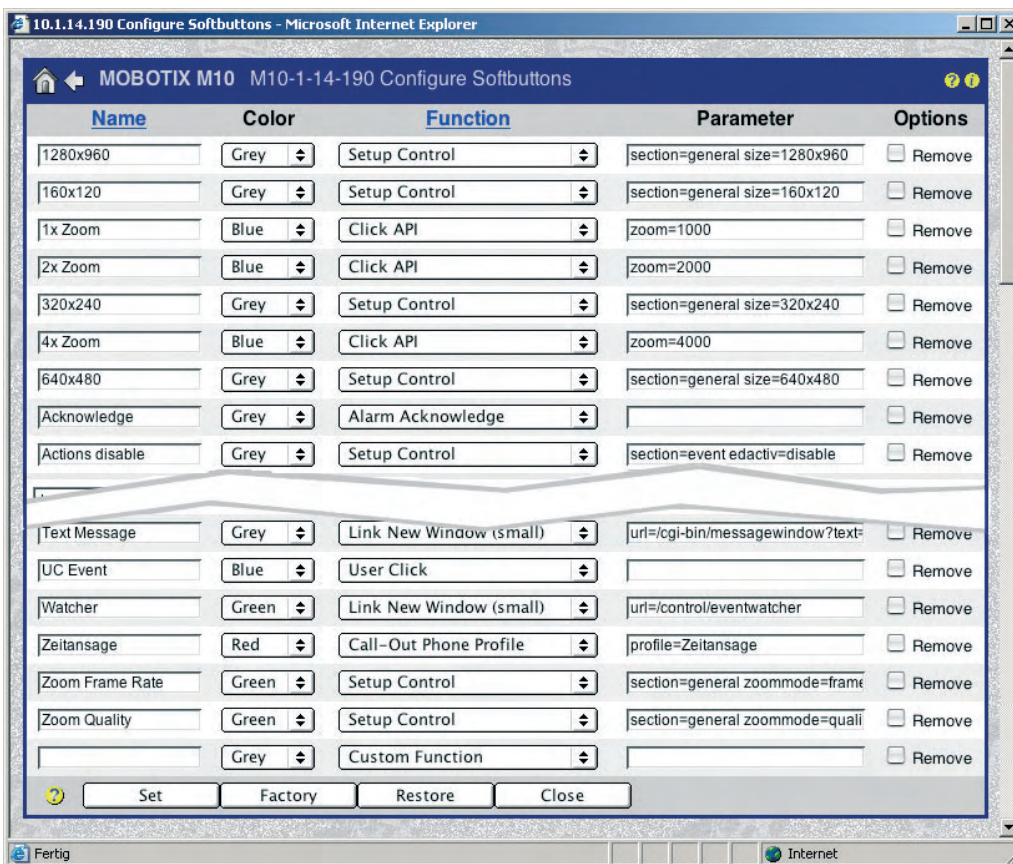

Some functions require information in the parameter field

The factory configuration has a pre-defined set of functions

The **Custom Function** option allows specifying any camera command (such as setting maximum exposure times, selecting specific exposure measurement windows, rotating the image by 180 degrees, ...). Use the custom function to execute any camera function and enter the corresponding values in the **Parameter** field of that line. The MOBOTIX camera thus offers highly flexible possibilities to adapt the user interface to the requirements of the current application (HTTP-API).

Custom softbuttons can execute commands of the HTTP API!

In order to delete certain softbutton definitions, activate the **Remove** check box and click on **Set**.

**Note**

You may **define and use different sets** of softbuttons for the Live, Player and MultiView screens.

After configuring a single **softbutton** using Shift-click, you should not forget to store the entire configuration permanently: **Admin Menu > Store current configuration into flash memory**.

A softbutton that is changed using Shift-click will be displayed immediately; when making changes in the **Admin Menu > Softbuttons** dialog, however, the changes are only displayed after reloading the corresponding camera screen.

See the *HTTP API* topic in the camera's online help and the reference manual if you would like get a list of available commands and parameters for the *Custom Function* option. For more information on the MOBOTIX camera's programming interfaces, see chapter 11, *Software Interfaces*. The HTTP API and how to control MOBOTIX cameras using HTTP commands is also one of the main topics of the MOBOTIX **Advanced Seminar** that is conducted by MOBOTIX specialists several times per year.

The functions of the defined softbuttons can also be executed manually when clicking on an image area in the **MultiView screen** or automatically by an alarm (see section 4.5, *The MultiView Screen in the Browser*).

HTTP API:  
Advanced Seminar

## 4.10 Fast Video Streaming

### 4.10.1 Overview

Besides the possibility to display fast video images using the JPEG mode with ServerPush or JScript, the **MxPEG** mode offers the following advantages when **displaying live video in a browser**:

- video sequences with realtime audio
- highest frame rates with minimal delay
- drastically reduced bandwidth requirements

See also section 4.3.5, *JPEG, MxPEG and Audio* as well as section 4.3.6, *Background Information on JPEG, MxPEG and Audio* for more information.

In order to see the MxPEG video sequences and to hear the sound from the camera microphone, you have the following options when using Windows:

- **MxPEG ActiveX plugin** for Internet Explorer
- **MxViewer**

The MxPEG plug-in and the MxViewer provide the same high frame rates. On top of this, the MxViewer can **simultaneously display 30 MOBOTIX cameras with 30 frames per second each** in CIF format (320x240; on a standard PC P4 with 3.0 GHz). Thanks to MxPEG, the performance demonstrated by MOBOTIX cameras is unmatched by other systems with similar prerequisites.

### 4.10.2 MOBOTIX Camera

Before you start using the MOBOTIX camera for fast video streaming (e.g. in security applications), you should apply the following settings to the camera (see also **Camera Settings** in section 4.10.3, *Simultaneously Displaying Several Cameras with High Image Rates*):

- Activate the MxPEG codec in the camera
- Adjust the frame rate (mega pixel resolution 1280x960 delivers lower frame rates than VGA resolution 640x480 or CIF resolution 320x240).
- Keep exposure times short (make sure enough light is present or set the maximum exposure time to *Max 1/60* or shorter: **Setup Menu > Exposure Settings**).
- Make sure the camera has no other tasks (e.g. FTP transmissions, sending e-mails, ...).
- Avoid showing logos and displaying text as much as possible.

#### MxPEG advantages:

- Realtime audio
- Highest frame rates
- Low bandwidth requirements

Kameramodel	X	-
X	-	-
X	-	-
-	X	-
-	-	X

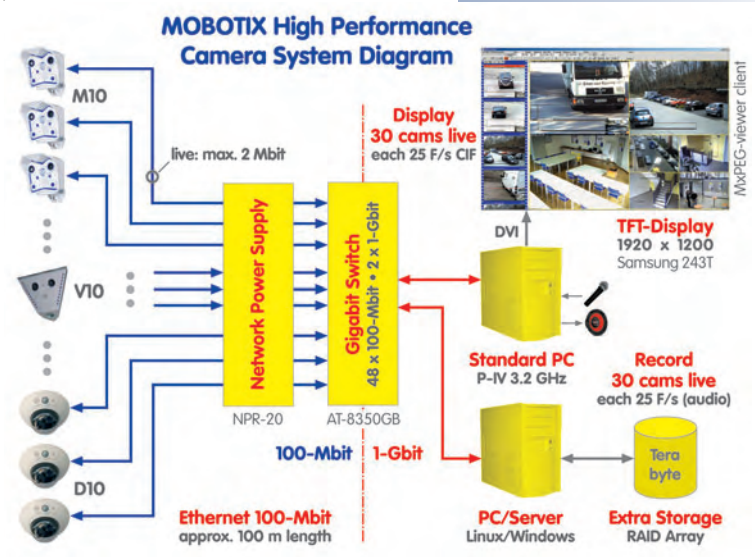

#### Caution:

Set the frame rate to the highest value or to "No limitation". You can use the Frame Rate Quick Control to change this setting.



### 4.10.3 Browser

The **MxPEG ActiveX Plug-in** allows transmitting the MxPEG video sequences including the audio channel of the camera when using Internet Explorer on Windows computers (see also section 4.3, *The Live Screen in the Browser*). If you intend to always use the MxPEG ActiveX plug-in, set the **Admin Menu > Language and Entry Page > Display Method** parameter accordingly.

In order to install the plug-in, start Internet Explorer and enter the IP address of a MOBOTIX camera. Installing the ActiveX plug-in is only required when starting the plug-in for the first time on the corresponding computer and may also be the case after updating the camera's system software, if it contains a new version of the plug-in.

Open the Quick Control **Browser > ActiveX** to start the plug-in. If the **current MxPEG ActiveX plug-in has already been installed**, the camera will briefly show a MOBOTIX logo before displaying the live image. To check if the plug-in has been installed properly, right-click directly into the live image. This should display the context menu of the ActiveX plug-in (see figure). If the **MxPEG ActiveX plug-in has not been installed** or if a newer version is available on the camera, the camera will not come up with the MOBOTIX logo; instead, the browser will prompt you to install the new ActiveX plug-in. Follow the instructions to complete the installation.

Quickly installed

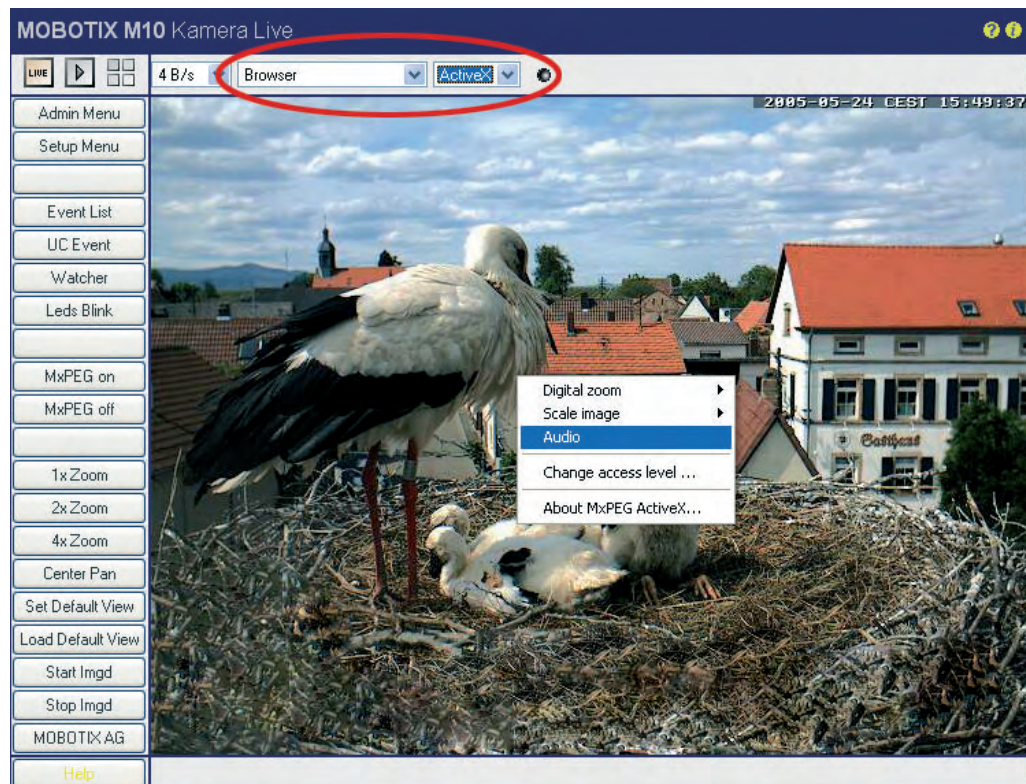

Right-click in live image

For further information on the **MxPEG ActiveX plug-in**, see *The Live Screen of the MOBOTIX Camera* in the camera help.

For more information on how to **integrate** the MxPEG ActiveX plug-in into your own applications, read section 11.4, *Video Streaming*.

### Note

In order to install the ActiveX plug-in, you need to have administrator or power user rights under Windows (from version 2000) and you need to agree to the installation. When working with older versions of the ActiveX plug-in, you may have to add the IP address of the camera to the list of trusted sites in Internet Explorer (**Tools > Internet Options > Security > Trusted Sites**)!

#### 4.10.4 MxViewer

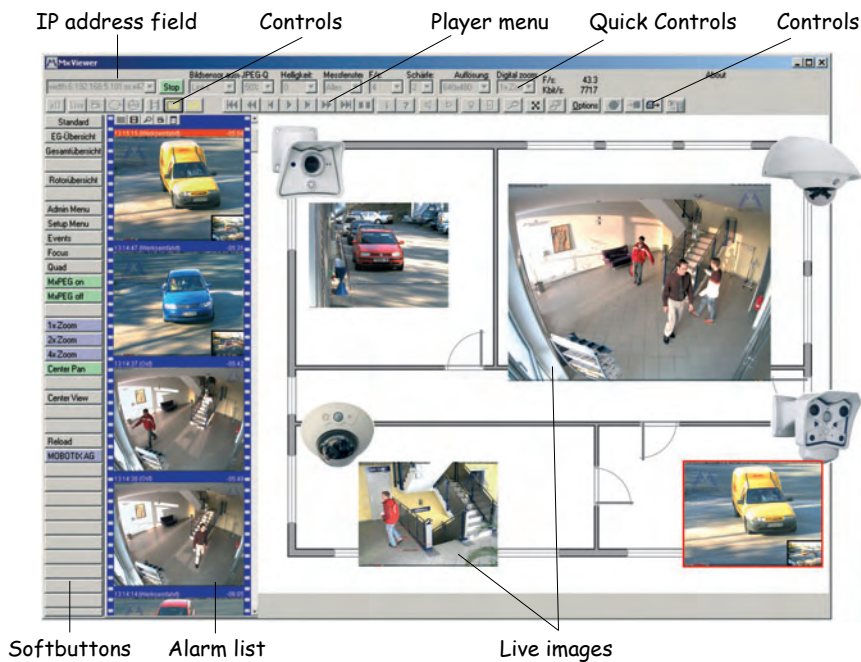

MxViewer for displaying the live images and the alarm list of several MOBOTIX cameras

Besides the **ActiveX** plug-in for Internet Explorer, MOBOTIX offers **MxViewer**, a free Windows application for displaying fast video with audio (sound).

Apart from displaying the video streams from different cameras, MxViewer has a number of other features:

- **Event list** shows a list of the latest events stored by the corresponding camera.
- Predefined **grids** provide for fast creation of different views and for easily switching between these views.
- **Layout editor** for quickly creating plans of buildings and surroundings. The defined cameras are simply placed on the plan using Drag&Drop.
- **Bidirectional audio transmission** between a camera and a Windows computer. A headset is all you need for a fully functional VoIP connection to the camera.

Kameramodell	X	-
X	-	
-	X	
-	-	X



- Buffering of video sequences on the Windows computer and saving these sequences as **MxPEG video clips with sound**.
- **Controlling camera image settings** from MxViewer.
- Automatic display of the **softbuttons** defined on the active camera.
- Integrated **pan/tilt head control** by clicking into the image with the mouse or by using a joy stick.
- **MxViewer is remotely controllable** from other computers or cameras (e.g. cameras can prompt MxViewer to show their images).

This list contains just a few of the MxViewer features. See the MxViewer online help for more information.

#### 4.10.5 Installing and Starting MxViewer

Download the newest version of MxViewer (EXE file) from [www.mobotix.com](http://www.mobotix.com). Apart from the latest version of MxViewer, the download area also contains the Windows help for the application.

Start the application and search for MOBOTIX cameras as described in section 4.2, *The First Image in MxViewer*.

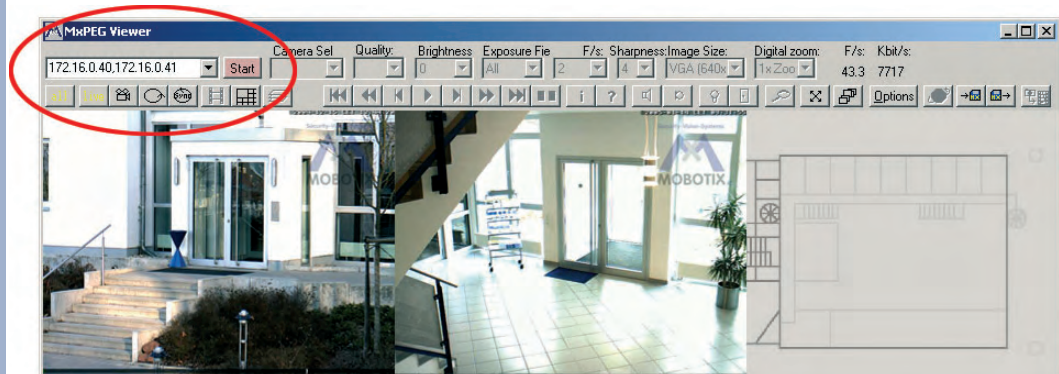

MxViewer displays the live images of the cameras it has found; the values for frame rate and bandwidth in the top right corner show the combined values for all displayed cameras. Clicking on a camera will activate this camera (yellow frame) and the frame rate and bandwidth values will be those of the active camera.

The pull-down lists below the title bar of MxViewer show the most important Quick Controls of the camera and always display the current values of the active camera.

Clicking on **Options** will display the options for the active camera. Use this dialog to set and store the user and password information for this camera. This dialog also allows setting the global options that are valid for all cameras. The remaining tabs of this dialog show the options for the other defined cameras.

For further information on **MxViewer**, consult the MxViewer help that you can download together with the application from [www.mobotix.com](http://www.mobotix.com).

For additional information on MxPEG, read section 4.3.5, *JPEG, MxPEG and Audio* as well as section 4.3.6, *Background Information on JPEG, MxPEG and Audio*.



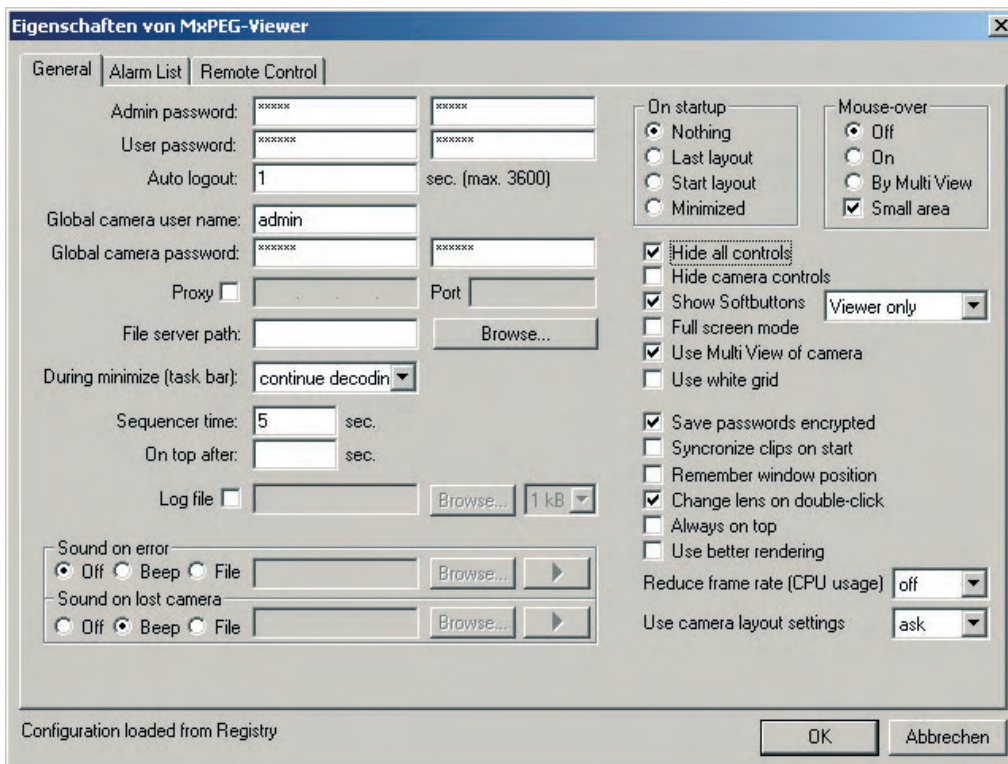

#### 4.10.6 Windows Processes

On a computer, several applications and processes are running simultaneously or silently in the background of the main application. In the current scenario, the main application is the video management system or control center software responsible for monitoring and reporting, e.g. MOBOTIX MxViewer.

The performance of a standard computer (P4, 3.0 GHz, 1 GB RAM) is sufficient to display e.g. 30 MOBOTIX cameras simultaneously (CIF format, 30 images per second each) on a high-quality TFT monitor without experiencing any performance issues.

Performance issues such as jerky display of live images may occur, when other applications or processes require CPU power or RAM. Therefore, it is recommended that you deactivate or uninstall such applications or processes. This may be anti-virus software, anti spyware, the task manager or logging applications as well as other processes that run discretely and usually cannot be uninstalled using the corresponding uninstaller software.



**Note**

Programs and processes can be displayed and removed using special applications (such as the Windows Task Manager). Deactivating or removing processes, however, may require fundamental knowledge of the operating system. Windows operating systems may require manipulating the Windows registry; on Linux systems, you may need to change configuration files. Make sure that you have the required knowledge before attempting to make these changes. We strongly recommend to backup your system before attempting to do this.

## 4.11 Operating Multiple Cameras

### 4.11.1 Overview

Modern video control centers are increasingly equipped with computers that supplement or replace analog video technology components and features. Due to the low resolution of TV screens, one monitor can usually display only one camera when using analog technology. Sometimes, up to four cameras need to be displayed on one screen resulting in even poorer image quality (quad display).

Using computers and high-resolution computer monitors opens the cost-efficient possibility to display considerably more than just four cameras on a single monitor while providing high resolution. In this scenario, the computer retrieves the IP cameras' data over the network and those of the analog cameras from a digitizer (frame grabber card). Camera management and display on one or several monitors is achieved through an application that, depending on its features, is called either a video management or control center application.

In the past, this solution had the disadvantage that one could not speak of *live* image display any longer if more than a handful of cameras were displayed. At a frame rate as low as two to five images per second, the display was jerky and not smooth.

This was due to the fact that displaying the video streams on the monitor required the computer to decompress the camera images previously compressed by an MPEG4 decoder. Uncompressed data, on the other hand, can only be transferred at highly reduced image quality and low resolution or not at all, due to the extremely high bandwidth needed and the resulting high network load.

This results in special performance requirements for the computer, the software and the compression method used (e.g. MPEG4, MxPEG). **The key to fast video display is the method of compressing and decompressing the video data as fast and efficiently as possible.**

MOBOTIX cameras can easily display more than four cameras on one monitor!

**The MOBOTIX MxPEG format in connection with MOBOTIX cameras is the only solution fulfilling these requirements.** The MOBOTIX concept offers a three times higher compression rate than Motion JPEG while only 30 percent of the computing power is needed (as compared to MPEG4).

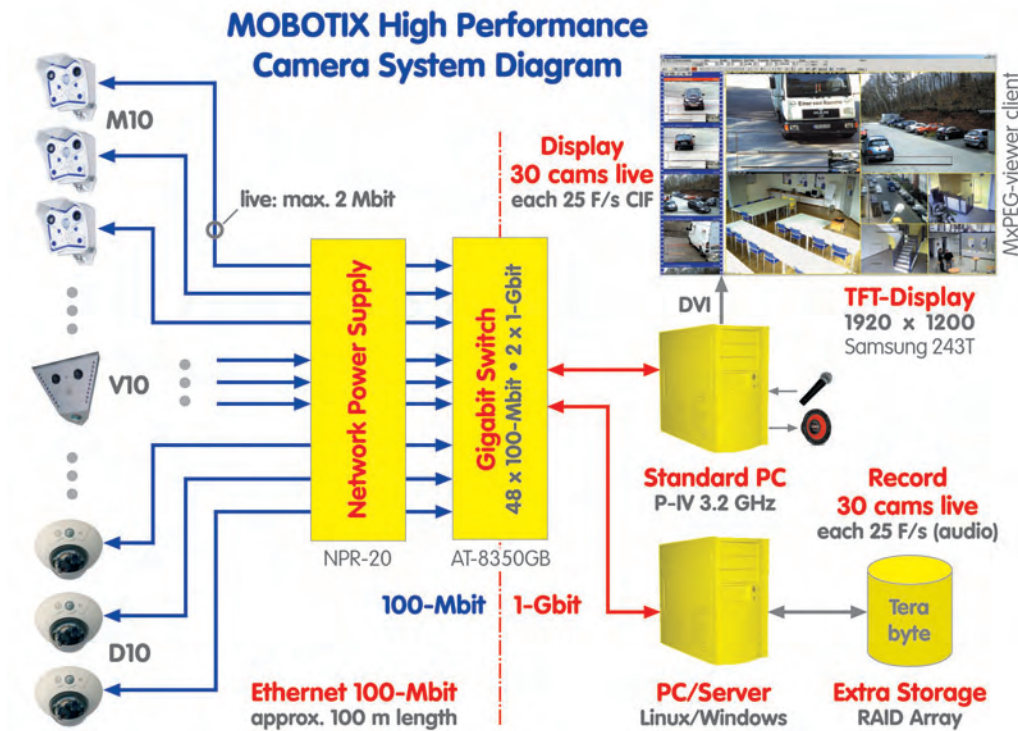

High-performance system consisting of MOBOTIX cameras, Windows computer running MxViewer and external ring buffer storage on servers

#### 4.11.2 Simultaneously Displaying Several Cameras with High Image Rates

In order to display as many cameras as possible with the highest frame rate on one monitor using just one computer, the following requirements must be met (see also section 4.10.6, *Windows Processes*).

##### Hardware:

- Standard computer (e.g. Pentium 4, 3 GHz, 1GB RAM)
- 1 Gbps network card
- High-performance graphics card (e.g. DVI, 128 MB RAM)
- High-performance TFT monitor (e.g. Samsung 243 T, 1920x1200 pixels)
- High-performance 1 Gbps switch (e.g. Allied Telesyn AT-8350)
- MOBOTIX M10, D10, V12 or M22 cameras
- MOBOTIX NPR-20 or NPR-8

**Software used:**

- Windows XP Professional
- MOBOTIX MxViewer

**Camera Settings:**

Click on the **Fast Mode (30 fps)** softbutton of the browser-based user interface to *automatically* execute the following steps:

- Set **operating mode** to *Frame rate mode* (if present).
- Set maximum **Frames per Second** to *No limitation*.
- Activate the **MxPEG** codec.
- Set **JPEG quality** to *40% (Medium)*.
- Set maximum **Exposure time** to *Max 1/60*.
- Set **Frequency of Power Supply** to *60 Hz*.
- Deactivate **Night Improvement**.

To further enhance camera performance, you should perform these steps *manually*:

- Set **Image Size** to CIF format (320x240 pixels; Quick Control or Setup Menu).
- Make sure the camera has no other tasks (e.g. FTP transmissions, sending e-mails, ...).
- Avoid showing logos and displaying text as much as possible.

**MxViewer Settings:**

- Storage Size: 4 MB
- Minimum Delay
- Full Screen
- Hide Controls

**Note**

The **Quality Mode** softbutton changes the settings to obtain the best possible image quality.





## 5 GENERAL CAMERA CONFIGURATION

### 5.1 Overview

The general camera configuration will ensure that all required parameters are set in order to adapt the camera to its operational environment.

#### Quick Installation

Using the Quick Installation wizard is the easiest and safest way for initially configuring your MOBOTIX camera. After booting the MOBOTIX camera for the first time, accessing the administration menu (**Admin Menu** button) will start the Quick Installation wizard. This wizard will ask for all required parameters in a step-by-step manner:

- Language of the user interface
- Activating speaker and microphone
- Camera Name
- Ethernet settings (IP Address, DHCP, Gateway, DNS Server)
- Parameters for ISDN Dial-In/Dial-Out
- Parameters for Phone Call-In/Call-Out
- Parameters for one image transfer to an FTP server
- Routing parameters (these set the "route" that the camera uses when connecting to the Internet (for e-mail or FTP), e.g. by using a gateway within the network or direct access via ISDN).

#### Note

Using the Quick Installation wizard (**Admin Menu > Quick Installation**) is recommended especially for inexperienced users when configuring a camera for the first time or when making changes later on, since the Quick Installation wizard is checking the configuration data for possible errors to avoid faulty configuration settings. All settings of the wizard may also be changed in the Admin or Setup menus, respectively.

#### Admin Menu and Setup Menu

The Admin and Setup menus contain links to all administrative dialogs that are necessary to configure your MOBOTIX camera. These dialogs also allow modifying the parameters later on that had been set originally using the Quick Installation wizard.

**Note:** In order to access the Admin menu, you need to enter a user name of the **admins** user group and the corresponding password (default: user name **admin**, password **meinsm**).



Administration menu:

User name: **admin**

Password: **meinsm**

The Quick Installation wizard has to be completed at least once

### 5.1.1 The Admin Menu

The Admin menu contains (among others) the dialogs for setting the Ethernet, ISDN dial in/out (data) and ISDN phone call in/out (voice) parameters. Other dialogs allow storing images on a file server, setting up DynDNS, routing or managing users and passwords. You will also find dialogs for troubleshooting, information on the camera hardware and software as well as the dialogs for configuring the MultiView screen and individual softbuttons. Dialogs for logo and image profiles, for time-controlled tasks, for the serial interface, configuring the camera LEDs, for the audio features and for setting the different profiles (see section 7.8, *Working with Profiles*) are added for setting the camera's special features. On top of this, you can save, retrieve, reset the configuration and transfer configuration data to other MOBOTIX cameras. Finally, the dialogs for updating the camera software and for rebooting are also in the Admin menu.

**MOBOTIX M10 mx10-1-9-1 Administration Overview**

- Release Notes**
  - News
  - Functional Overview
  - Release Notes
- System Information**
  - Hardware and Release Information
  - Camera Status
  - Temperatures
  - System Messages
- Security**
  - Users and Passwords
  - Group Access Control Lists
  - Web Server Logfile
- Page Administration**
  - Language and Entry Page, Web Server Ports
  - Softbuttons
  - Multi View Screens
- Network Setup**
  - Quick Installation
  - Test Current Network Configuration
  - Ethernet Interface (for experts)
  - ISDN Data Connections (for experts)
  - Routing (for experts)
  - Dynamic DNS Client (for experts)
- LAN Image Storage**
  - Event Storage on external file server
  - File Server Checks
- Logos and Image Profiles**
  - Manage Image Files
  - Logo Profiles
  - Image Profiles
- Transfer Profiles**
  - FTP Profiles
  - E-Mail Profiles
  - IP Notify Profiles
- Audio and Phone**
  - Loudspeaker and Microphone
  - Manage Voice Messages
  - VoIP Settings for SIP telephony
  - Phone Profiles for outgoing SIP/ISDN voice calls
  - Phone Call-in for incoming SIP/ISDN voice calls
  - Camera Phone for making direct SIP/ISDN voice calls to other phones
- General Administration**
  - Time and Date
  - LED Setup
  - Time Tables for arming and services
  - Time Tasks for image transfer and other jobs
- Serial Interface**
  - Setup of serial interface, modem and weather station
  - Serial Terminal
  - Signal State
- Configuration**
  - Store current configuration into flash memory
  - Reset configuration to factory defaults
  - Restore last stored configuration from flash
  - Load configuration from local computer
  - Save current configuration to local computer
  - Show current configuration (raw version)
  - Edit configuration file (for experts)
  - Manage other cameras
- System Update**
  - Update System Software
- General Tasks**
  - Reboot the camera

**Security Warning:** Browsers retain password information until they are closed completely. To prevent unauthorized use of protected pages, make sure that you close all browser windows at the end of your session. Failing to do so will leave the password in the browser cache and other users may manipulate your camera(s)!

Administration menu:

User name: **admin**

Password: **meinsm**

### 5.1.2 The Setup Menu

The Setup menu contains the **image control** and **event control** dialogs.

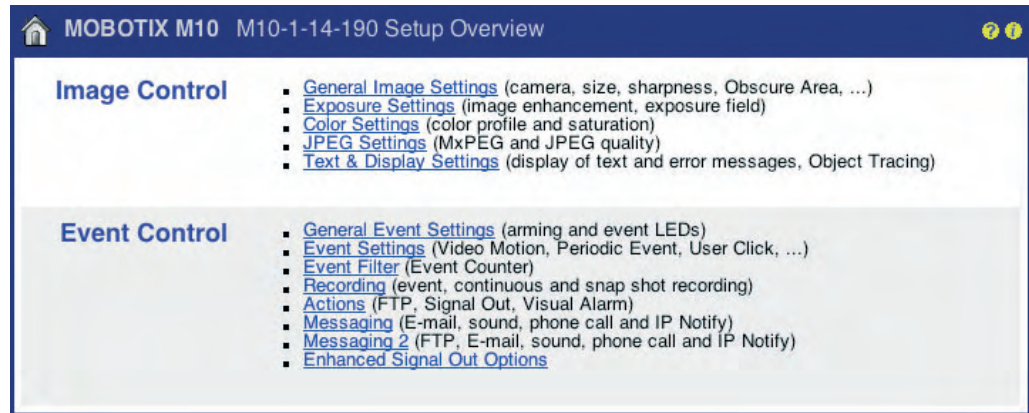

Setup Menu for image and event settings

#### Image Controls

In this section, you can select the desired image sensor (right, left), image resolution, brightness, color, contrast, backlight correction, image sharpness, JPEG quality, MxPEG or JPEG mode, exposure times and exposure windows, darkness options, object tracing as well as the display of text in the camera image. For more detailed information on the image settings, see sections 5.5, *Image Control*, 5.7, *Exposure Settings*, and 5.8, *Day & Night Modes*.

Image sensor selection, resolution, text display

#### Event Control

In this section, you can activate events and assign specific actions and messages to these events. In addition, you can activate image recording and set the recording method.

An event can trigger the MOBOTIX camera to perform a certain action or to send a message, e.g. when the camera detects a movement or the microphone detects noises above the defined level. This event can also start the recording of event images or event clips with or without audio in the camera's internal ring buffer or an external ring buffer on a file server.

Generally speaking, the desired events need to be activated and the MOBOTIX camera has to be armed (**Setup Menu > General Event Settings**). Using the time tables, it is possible to arm the camera only for certain times, days of the week and holidays (**Admin Menu > Time Tables**). The time tables can also be combined with a key switch that is connected to the camera's signal input. Likewise, you need to activate the desired actions and messages.

**In order to record images, clips and sound, make sure that you activate the recording feature (Setup Menu > Recording).**

Events, Actions, Messaging and Recording

Arming the MOBOTIX camera!

Kameramodell	X	-
X	-	-
X	-	-
-	X	-
-	-	X

**Available events (model-dependent):**

Passive Infrared Sensor (PI), Video Motion windows (VM, VM2), Microphone (MI), Signal Input (SI), Signal Inputs (SI2, SI3, SI4), Periodic Event (PE), Time Task (TT), User Click (UC), IR Remote Control (IR), IP Receive (RC), Com In (CI), Temperature (TP), Illumination (IL), Random Event (RD), Event Filter (EC) and Event Logic (EL, EL2) as well as the Recording events (Recording Begin RB, Recording End RE, Recording Terminate RT, Recording History RH).

**The following actions and messages are available (model-dependent):**

Signal Out Action (SO), File Transfer Action (FT), Visual Alarm (VA), Sound on Event (SD), E-Mail (EM), Phone Call-Out (CL), IP Notify (IP) and LED signalling.

**The following recording modes are available (model-dependent):**

Event-controlled recording (clips) with/without audio (sound), Continuous Recording with/without audio, Snap Shot Recording and History Recording.

For more detailed information on events, actions and messages, see chapter 7, *Events, Actions and Messages*. Chapter 8, *Recording*, describes the different recording modes.

**The "More" and "Less" buttons**

When opening some of the camera dialogs, only the most important configuration options are displayed by default. These dialogs have a **More** button in the bottom right corner; click on it to display additional options. If all options are displayed, click on the **Less** button to hide the additional options.

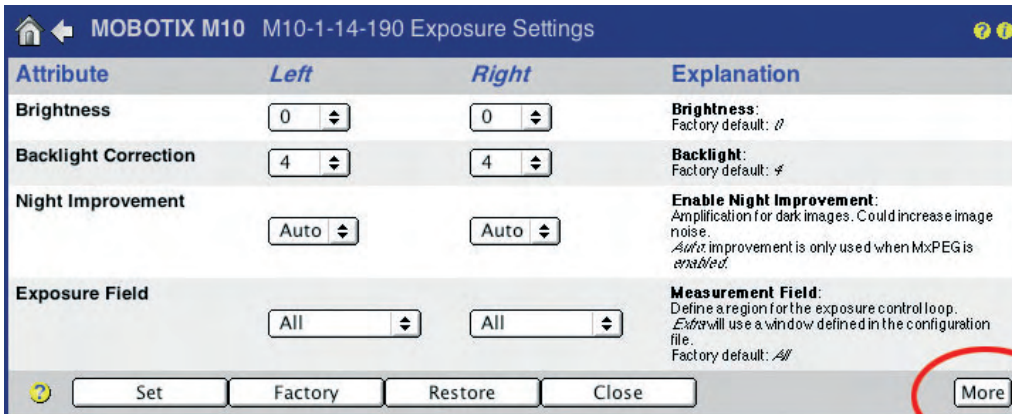

Events



Actions, Messaging



Recording Types

More:  
Display advanced features  
Less:  
Hide advanced features

Adding the line `expandmenu=on` in the `homepage` section of the configuration file will always display all options when opening a camera dialog



## 5.2 Quick Installation

### 5.2.1 Overview

The Quick Installation wizard provides an easy-to-use and safe method for setting up your MOBOTIX camera (**Admin Menu > Quick Installation**). After booting the MOBOTIX camera for the first time, any access to the administration menu (**Admin Menu** button) will start the Quick Installation wizard.

Quick Installation  
for easily setting up  
MOBOTIX cameras

To revert to the previous  
settings of a page, click  
on **Reset Page**



Selecting and configuring the network interfaces is one of the most important tasks performed during quick installation. The settings defined in this step determine how the camera can be accessed from the outside and how the camera itself can communicate with the "outside world".

On the **Network Interface** page, the following interfaces are available:

- Ethernet for LAN
- ISDN Dial-In (from other computers into the camera)
- ISDN Dial-Out (from the camera to e.g. the Internet)
- ISDN Phone Call-In (from a phone to the camera)
- ISDN Phone Call-Out (from the camera to a telephone)



It is possible to activate all network interfaces at the same time and to proceed with the Quick Installation. It is recommended, however, to only activate the *Network* option at first and to configure the camera using the required network parameters (e.g. leave the camera's IP address and the suggested network mask untouched, select *No Default Route*. If required, you can enter the Gateway Address and DNS Server information). Using these settings, you can connect your MOBOTIX camera to a computer or a local network (see chapter 3, *Operating the Camera*, in the corresponding *Camera Manual*).

In order to set up the camera for additional network interfaces later on, you can run the Quick Installation wizard again. Make sure to select the **Modify Current Configuration** option on the **Factory Reset** page in order to keep already configured parameters such as Image Settings or Event Settings.

**ISDN Dial-In:** If you intend to allow accessing the camera using an ISDN dial-in connection (e.g. via an ISDN RAS connection from a computer), you need to configure ISDN dial-in next.

### Caution

If you are remotely configuring a camera using an ISDN dial-in connection, make sure that you do not deactivate ISDN Dial-In. You will not be able to access the camera via ISDN otherwise.

**ISDN Dial-Out:** In order to allow the camera to actively access the Internet (e-mails, FTP server), you either need to activate ISDN Dial-out (Internet access via an ISDN connection) or provide Internet access by specifying a gateway (router) on the local network. In this case, you do not have to activate ISDN dial-out. All you have to do is to set the standard route to Network when configuring the network in the Quick Installation wizard (this is dependent on other parameters as well). In addition, you need to specify a gateway address and at least one DNS server. Contact your network administrator to obtain the required information.



**Data Dial-In** for access to the camera using ISDN



**Data Dial-Out** for sending e-mails and using FTP for image transfers

### 5.2.2 Quick Installation Pages in Detail

The Quick Installation wizard will display the following pages:

#### Language

Select the language for the user interface of the camera.

The MOBOTIX camera software always contains two language versions, i.e. **English** plus one additional language (**German**, **French**, **Spanish**, **Italian**, **Japanese** or **Chinese**; other language versions will be available soon). You can download the camera software and the desired language packs free of charge from [www.mobotix.com](http://www.mobotix.com).

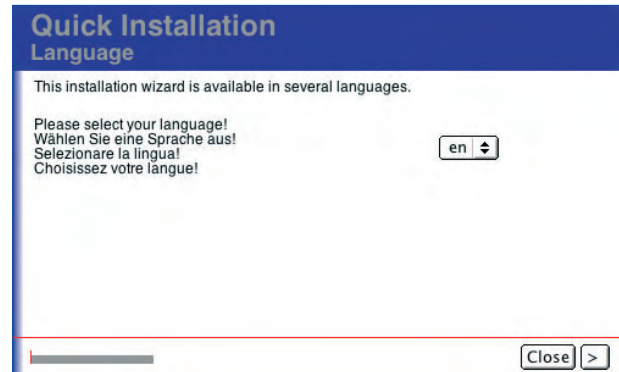

Select the language for the user interface of the camera

#### Introduction

This page gives an overview of the camera functions and of new features included in the current camera software version. No entries are required on this page.

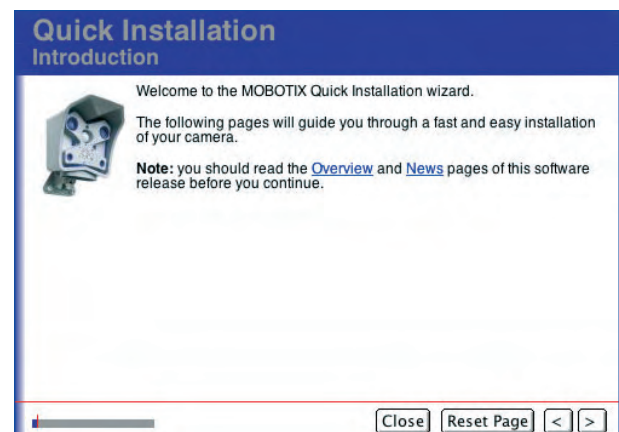

#### Factory Reset / Keep Current Configuration

If you would like to use the default configuration, select the **Dismiss current configuration** option. This means that all previously configured settings are reset to the factory default values. The settings are stored in the permanent (Flash) storage of the MOBOTIX camera at the end of the Quick Installation wizard.

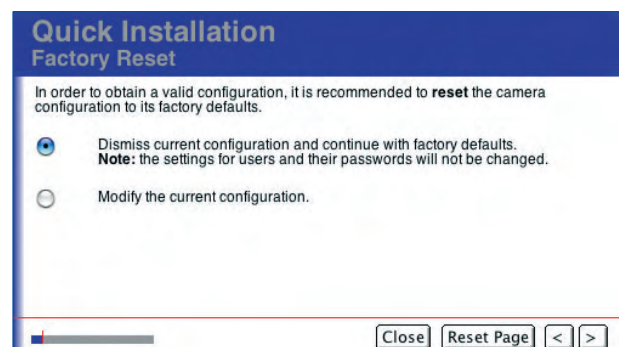

Reset the camera to factory settings

Modify the current configuration

If you select the **Modify the current configuration** option, the camera will use the previously configured settings. In the course of the Quick Installation, you are free to keep these settings or to change them.

**Security / Admin User**

This page allows modifying the password of the default administration user (user name **admin**, password **meinsm**). It is recommended to at least change the Admin user's password and to create a second user with a different user name and password later on who also belongs to the **admins** user group. Note that every user with direct access to your camera who has been assigned administration privileges can view and modify not only the settings of your MOBOTIX camera but also the passwords.

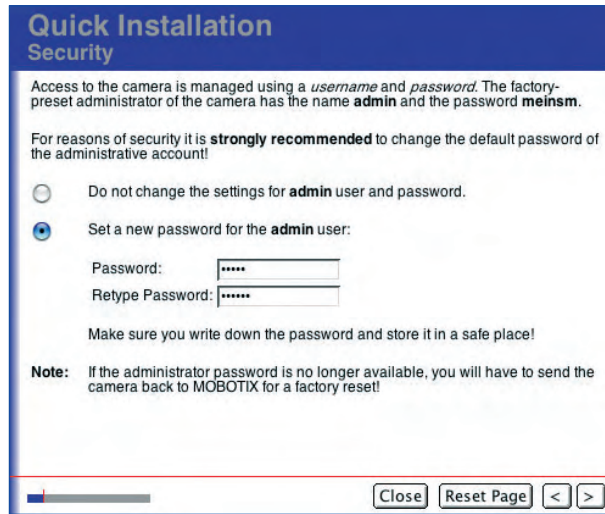

This page will not be shown if you selected **Modify the current configuration** on the previous page.

**Caution**

If the administration password (factory default: **admin**, password **meinsm**) has been changed and the information has been lost, accessing the Admin Menu of the camera **is not possible any more**. Even resetting the camera to factory defaults using the **L key** of the camera will **NOT reset the passwords!** A camera that is not accessible any more has to be sent back to the MOBOTIX factory or subsidiary for a full factory reset (this service is not free!).

Administration menu:  
 User name: **admin**  
 Password: **meinsm**

**Public Access**

By factory default, most of the camera's screens and functions are publicly accessible, i.e. they do not require a user name and password to access them. In order to protect all functions of the MOBOTIX camera from unauthorized access, you should activate the authentication feature on this page.

If required, you can deactivate this parameter later on in **Admin Menu > Users and Passwords**.

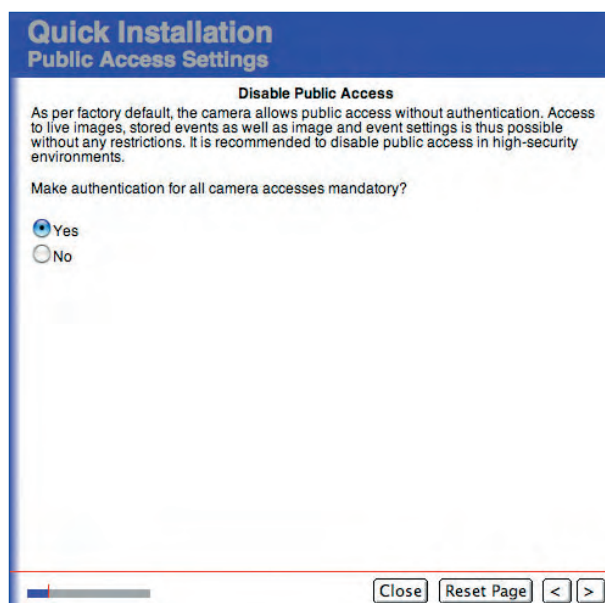

Disable public access



### Country Settings / Timezone

Select the timezone that is applicable for your country (e.g. Europe/Berlin for Germany). The **Admin Menu > Time and Date** dialog allows setting a time server for automatic time synchronization. Section 5.4.2, *Date and Time / Time Zones and Time Server*, contains more information on this topic.

Automatic time synchronization using a **time server**

Kameramodel	X	-
Kameramodel	X	-
Kameramodel	-	X
Kameramodel	X	X

### Audio Settings / Microphone and Speaker

As per factory default, the MOBOTIX camera's speaker is activated while the microphone is deactivated. Change these settings, if desired.

The microphone can be deactivated **irreversibly**

**Quick Installation**  
Country settings

Select the timezone that is applicable to the location of the camera.

Timezone:

Current camera time: 2004-09-22 12:45:38 CEST

**Hint:** you can set the camera time in **Admin Menu > Time and Date**.

Close Reset Page < >

**Quick Installation**  
Audio Settings

The camera has a built-in microphone and loudspeaker: Using its integrated ISDN port, you can use the camera as an ISDN telephone. MxPEG Viewer can transmit the audio channel from a computer to the camera and back using a TCP/IP connection. If you press the **R** key on the camera's front, the camera will announce its network data over the loudspeaker.

Activate or deactivate these devices:

Microphone

Speaker

**Note:** if you need to permanently deactivate the microphone, open **Admin Menu > Loudspeaker and Microphone**, click on **More**, and then on the **disable** link.

Close Reset Page < >

### Note

For certain cases, you can permanently and irreversibly deactivate the microphone in the **Admin Menu > Loudspeaker and Microphone** dialog (if required for privacy protection of employees, for example). Be careful as even MOBOTIX engineers cannot reverse the permanent deactivation! For additional information on this topic, see section 5.4.5, *Loudspeaker and Microphone*.

### Camera Name

This page allows setting an individual name for your MOBOTIX camera. This name provides for easy identification of the camera (e.g. in a MultiView configuration) and is also stored in the JPEG header of every image file. The camera name may consist of any letters (**A...Z, a...z**), digits (**0...9**) and the hyphen (**-**).

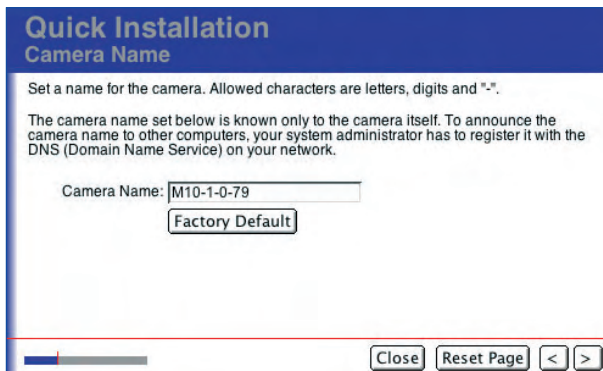

The camera name may contain the following characters:  
A...Z, a...z, 0...9, the hyphen ("-")

Set the camera name so you can identify its position (**example: Staircase1**)

Caution: If you would like the MOBOTIX camera to be accessible in the local network using the same name, your network administrator will need to add this name to the Domain Name Service (DNS) of your local network. The camera name, which is set during Quick Installation or in **Admin Menu > Ethernet Interface** is used for other purposes. Contact your network administrator for assistance regarding the DNS entry.

The camera's name is also used to identify the camera in MultiView mode

### Network Interfaces

Your network interface selection determines the way your MOBOTIX camera can communicate with the outside world using data and voice connections and how the MOBOTIX camera can be accessed from the outside using data and voice connections.

For accessing your camera using a browser, you can either use an **Ethernet** or an **ISDN connection**. Thus, you need to activate at least one of the two options (Network or ISDN Dial-In) on this page of the Quick Installation wizard. For the basic configuration, we recommend to only activate the **Ethernet for LAN** interface.

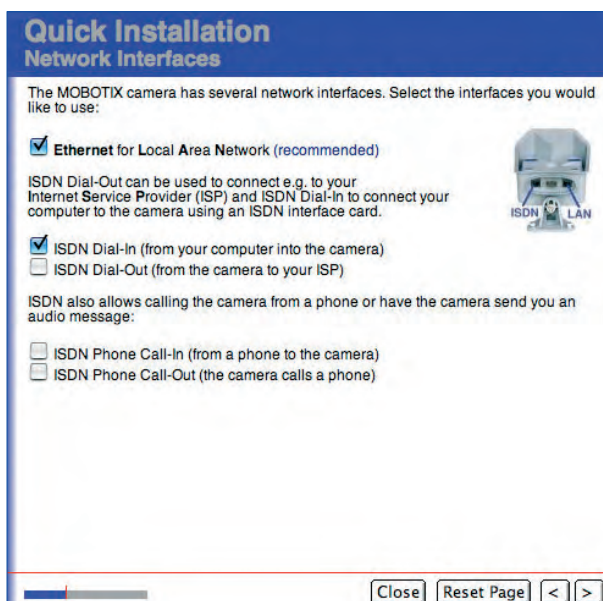

X	-
X	-
-	X
-	X

By activating the **Ethernet for LAN** interface, you enable the camera to send images and data via Ethernet or an Ethernet gateway (e.g. FTP and e-mail). If you have activated the **ISDN Dial-Out** interface, the camera can send data using an ISDN connection.

You should always activate the **Network!**

If you have selected both interfaces, you may define a *Default Route* that determines the default connection for the data transfer. For additional information on this topic, see the paragraph *Default Route* further down.

Remote-controlling the camera using a phone

The camera can call you on your phone as well



Every MOBOTIX camera has its individual factory IP address (10.x.x.x)

If the **ISDN Dial-In** interface has been activated, the camera acts like an Internet provider. To connect to the camera, create a RAS connection on your computer and enter the phone number of the camera as well as the user name and password of your camera (default: user name **linux**, password **tux**). Note that the computer has to have an ISDN interface card installed that is working properly. For additional information on this topic, see the *ISDN Dial-In* section further down.

The **Phone Dial-In** interface enables you to control your MOBOTIX camera using a standard phone or mobile phone (mobile) with touchtone keys. In this case, the camera uses an ISDN connection. The caller may use any type of connection (e.g. analog, ISDN, GSM or IP phone).

The **Phone Call-Out** interface enables the camera to call other telephones and to play back voice messages (e.g. when detecting an alarm). In this case, the camera uses an ISDN connection. The called party may also use any type of connection (e.g. analog, ISDN, GSM or IP phone).

### DHCP and Manual IP Address / IP Address and Network Mask of the Camera

The **Network Interfaces** page and the following ones displayed by the Quick Installation wizard contain all parameters to establish a network connection using the camera's Ethernet interface. These pages are only displayed if you have activated the **Ethernet for LAN** interface on the **Network Interfaces** page.

**Quick Installation**  
Ethernet Interface

The camera can be connected directly to all computers on the LAN using the **Ethernet** interface. To do so, it has to be assigned a unique *IP address*.

This can be done **manually** or **automatically** if you have a *DHCP* service running on your network.

DHCP allows hosts on a TCP/IP network to obtain IP addresses for themselves and other information about the network to which they are attached.

Request IP Address and network configuration **automatically** using DHCP.  
**Hint:** if you press the **R** button at the front of the camera, it will announce its network configuration.

Configure Ethernet interface **manually**.

**Quick Installation**  
Ethernet Interface

Assign a unique **IP address** and the **network mask** to the camera. These values consist of four numbers (0 to 255) separated by dots. They define which other IP addresses can be reached directly on your LAN. In order to access the camera from your computer via LAN, your computer needs an IP address on the same subnet as the camera.

If unsure, ask your system administrator for a valid and unique IP address and the network mask of your subnet.

Camera IP Address:

Camera Network Mask:

**Hint:** the factory IP address of this camera is **10.1.0.79**, the network mask is **255.0.0.0**. If these values match your network, the factory defaults should be used.

Manual configuration of the network interface or automatic configuration using **DHCP**

You can either choose the manual configuration (fixed IP and network mask) or DHCP (dynamic IP and network mask assigned automatically by the DHCP server). If you have chosen manual configuration, you need to enter the camera's desired IP address and the appropriate network mask of your network on the following page. Click on **Factory Default** to use the MOBOTIX default settings.

**Note**

The MOBOTIX camera can announce the IP address it automatically obtained from a DHCP server after rebooting (see section 3.5, *Starting the Camera With an Automatic IP Address (DHCP)*, in the *Camera Manual*). Make sure that the speaker is still activated (default) in the **Admin Menu > Loudspeaker and Microphone** dialog to use this function.

**Caution**

Before starting the camera with DHCP support, make sure that the DHCP server is running properly. If this is not the case, the camera cannot obtain a valid IP address and will fall back to its last IP address or the factory IP address.

**Camera MSN**

If you have activated one of the interfaces **ISDN Phone Dial-In**, **ISDN Phone Dial-Out** or **ISDN Dial-In**, you will be prompted to enter the camera MSN on this page.

The camera's MSN (Multiple Subscriber Number) is the phone number that must be used to access the camera via ISDN Phone Dial-In or that the camera uses to identify itself during ISDN Phone Dial-Out (e.g. on the display of a mobile phone). In order to create a dial-in connection from a computer, you need to enter the MSN in the RAS Connection dialog.

Enter a unique MSN that is still available for your telephone number. Make sure that this MSN is not identical with that of any other device on this ISDN bus. This means that you can operate e.g. a telephone, a computer and a MOBOTIX camera simultaneously on the same ISDN bus.

When connecting the camera directly to an NT, use one of the MSNs (without prefix) your provider has assigned to your ISDN line.

When connecting the camera directly to an NT, use one of the MSNs (without prefix) your provider has assigned to your ISDN line.

If the camera is connected to a telephone system, the MSN may be hard to determine. For this reason, your MOBOTIX camera can determine its MSN automatically. Simply call the camera from a phone by dialing the number of the telephone line (e.g. the extension). Then click on **Determine MSN** in the Quick

**Quick Installation**  
**ISDN MSN**

The camera MSN (Multiple Subscriber Number) is the telephone number of the camera itself. Enter a unique MSN to operate e.g. a telephone, a computer and the camera on the same ISDN line.

On most ISDN lines you can have several different MSNs. When connecting directly to a NT, use one of the numbers (without prefix) your provider assigned to your ISDN line.

Camera MSN:

If the camera is connected to a telephone system, the MSN may be hard to determine. For this reason, the camera can determine its MSN automatically. Call the camera from any telephone and then click here:

**Note:** you may set different MSNs for connecting to the camera by computer or telephone in the **ISDN Interface** or **ISDN Audio Call-In** dialogs, respectively.



**The MOBOTIX camera can automatically determine the MSN!**



**Note**

**Note:** Normally, your provider will assign three MSNs to one ISDN line. Please note that—depending on the type of ISDN line you are using—you may have only **two ISDN channels** available, so only two devices can establish an active connection at the same time.

Installation wizard. When calling the number "17" within your telephone system, the returned MSN may be "2".

If it is not possible to determine your camera's MSN using this method, you need to contact the administrator of your telephone system. You may also enter a fake MSN (e.g. "12345") first and change it to the correct one later on (**Admin Menu > ISDN Data Connections > Dial-In Connection > Camera MSN**).

If you do not enter an MSN (possible only for **Data Dial-In**), your MOBOTIX camera can be accessed via any MSN assigned to your ISDN line.

**Note**

If the camera receives a telephone call, the camera displays the caller's phone number (MSN) in the **Admin Menu > Phone Dial-In** dialog. You can then automatically copy the MSN to the corresponding field.

**ISDN Dial-Out / Provider**

If you have activated the **ISDN Dial-Out** interface, you are prompted to enter your Internet provider's access information (e.g. T-Online, Arcor, Freenet, MSN, etc.). Contact your provider to obtain the access information. You may also use any call-by-call access. You will find that certain Internet providers have been preset on your MOBOTIX camera. Please note that these connections are not free of charge. For detailed information, please contact your Internet provider or call-by-call service.

Kamermodell	X	-
X	-	-
-	X	-
-	-	X

If you are using a telephone system and the camera requires an outside line, make sure that you add all required prefixes to successfully get an outside line.

**Quick Installation**  
**ISDN Dial-Out**

Using *ISDN Dial-Out*, the camera can call your ISP (or another ISDN server) via ISDN to connect to the Internet or any other network. The information required below is usually provided by your ISP.

If your camera is connected to an in-house phone system, you may have to add a prefix to obtain an outside line.

Phone Number to Call:     
 Login Name at ISP:   
 Password at ISP:

**Note:** dial-outs are limited to a maximum duration of 180 minutes and a count of 50 per day. After exceeding one of these limits, dial-out will be blocked. You can change these values in **Admin Menu > ISDN Interface**.

**Note**

In order to limit the costs for ISDN connections, dial-outs are limited by factory default to a maximum duration of 180 minutes and a maximum of 50 per day. After exceeding one of these limits, your MOBOTIX camera will block further dial-out attempts. You can modify these settings later on (**Admin Menu > ISDN Connections > Dial-Out Parameters**).

**ISDN Dial-In**

If you have activated the **ISDN Dial-In interface**, you can enter a user name and password on this page. When you dial-in to your MOBOTIX camera using an ISDN card or modem, you need to enter the corresponding access information as well as the camera's telephone number in the RAS configuration dialog of your computer. For security reasons, we strongly recommend that you change the default user name (**linux**) and the default password (**tux**).

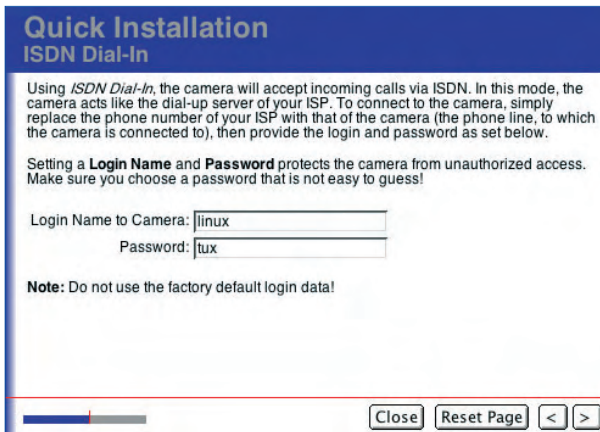

RAS access data:  
User name: **linux**  
Password: **tux**

**Default Route**

By defining a standard route, you set your camera's standard connection for transferring data (e.g. for FTP connections, e-mails, etc.).

*No Default Route:* This option is only available if you have activated the **Ethernet for LAN** option on the **Network Interfaces** page and have activated neither the **ISDN Dial-Out** nor the **ISDN Dial-In** interfaces. Choose this option if the camera is not supposed to transfer data to the outside world.

*Network:* Select this option if you would like data to be transferred using a certain router within the network, the so-called "gateway". Enter the IP address of the gateway provided by your network administrator.

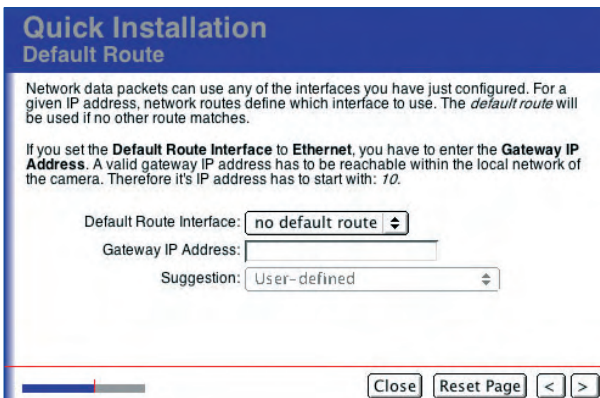

The Default Route allows using different gateways for different tasks

**ISDN Dial-Out:** Select this option if you would like data to be transferred using ISDN and the camera itself has to establish the ISDN data connection (i.e. it dials out automatically).

**ISDN Dial-In:** Select this option if you would like the camera to be accessed via a dial-in connection established by another device (ISDN router or computer) to your camera's ISDN interface.

If you cannot decide on a default route, do not change the *No Default Route* setting for the time being and proceed with the instructions given in the Quick Installation wizard.

### Network Route

If you have activated the **Ethernet for LAN** and the **ISDN Dial-Out** interfaces on the **Network Interfaces** page and you have set **Network** as default route, you need to define a route for ISDN Dial-Out at this point. Enter the IP address of the target network and the corresponding network mask. Ask your network administrator to provide the access information for ISDN Dial-Out.

### Domain Name Service (DNS)

The Domain Name Service (DNS) resolves symbolic computer names (like **www.mobotix.com**) to their numeric IP addresses. Normally, an external DNS server is used that is not part of the local network. Your network administrator or Internet provider will provide the IP addresses of potential (public or local) DNS servers.

To ensure accessibility of a public DNS server, make sure you have correctly configured the Ethernet interface and a valid gateway IP address.

**Routing** allows setting the routes to be used by the camera for connecting to different networks



Set the DNS server(s)

If you have activated the **ISDN Dial-Out** interface and set it as the default route, you will not be prompted to enter a DNS server. In this case, the DNS servers of the provider are used that will be assigned automatically when establishing the ISDN connection.

**Note:** You can enter up to three different IP addresses in the **DNS Server IP Addresses** field (one per line). Defining several DNS servers provides a safeguard against failures if one of the servers cannot be reached.

**ISDN Phone Dial-In**

If you have activated the **ISDN Phone Dial-In** interface on the **Network Interfaces** page, you are prompted to enter a PIN number in this dialog (default is **1357**). When you try to access your MOBOTIX camera from a



telephone, you will need to enter this PIN first in order to activate the remote control via telephone.

**Quick Installation**  
ISDN Audio Call-In

The camera will be configured to answer voice calls, i.e. you can call the camera from a telephone. If your telephone supports touchtones (DTMF), you will be able to control some important functions of the camera.

If you connect the camera to the public telephone network, the camera can be called from every telephone. Therefore to protect against unauthorized access you need to set a **PIN** (Personal Identification Number.)

PIN:

After successfully connecting to the camera, no audio mode will be activated as the microphone is not available. Enable the microphone to activate an audio mode. You can configure more parameters in **Admin Menu > ISDN Audio Call-In**.

**Hint:** if you want to remote control the camera's internet connection and have it announce the dynamically assigned IP address you need to configure ISDN Dial-Out.

X	-
X	-
-	X
-	X

Factory default PIN for Phone Call-In: **1357**

For additional information on this topic, see section 9.6, *Remotely Controlling the Camera Using a Phone*.

**ISDN Phone Call-Out**

If you have activated the **ISDN Phone Dial-Out** interface on the **Network Interfaces** page, you are prompted to enter a phone number in this dialog. When making a (voice) phone call to a telephone, the camera will dial this number. You can change this telephone number in **Admin Menu > Phone Profiles** later on and you can also add more telephone numbers to be called until a call has been completed successfully.

**Quick Installation**  
Phone Call-Out

The camera can use the ISDN connection to call a telephone and it will play back a pre-recorded message. Next, you could switch to Listen mode to hear what the camera microphone is recording.

The wizard will now configure an audio call-out profile named **Quickinstall**. Enter a phone number!

Phone Number to Call:

**Note:** if the camera should use this profile in case of an event, open **Setup Menu > Messages** and select the **Quickinstall** profile in the **ISDN Call Action** drop-down. If an event occurs, the camera will call you and will play back the message. The camera will then hang up since the microphone is not available. To enable the **Listen** mode, activate the microphone first.

To change this profile or add new ones, open **Admin Menu > Phone Profiles**.

X	-
X	-
-	X
-	X

Do not forget any prefixes required to get an outside line!



Ask your Internet service provider for FTP access information

MOBOTIX offers a free FTP test account for a limited amount of time: [intl-support@mobotix.com](mailto:intl-support@mobotix.com)

### Image Transfer to FTP Server

On this page, you can set the access data for transferring images to an FTP server. This FTP server could be either an external web server on the Internet or a local FTP server on a computer in your network.

If you do not want to configure image transfer via FTP, leave these text fields untouched and proceed with the Quick Installation wizard.

If you have configured an external FTP server (web server), your website provider should give you the access information once your domain has been set up. In the **FTP Server IP or Name** field, you can enter either the domain name (e.g. **www.mobotix.de**) or a (numeric) IP address. In any case, make sure to enter the correct user name and password for the FTP connection.

Note that the FTP server name must be entered without mentioning the protocol (no `http://` or `ftp://` prefix), e.g. **www.mobotix.de** (**not** `www.mobotix.de` or `ftp://ftp.mobotix.de`). The same applies when entering the FTP server's IP address. Enter it **without** `http://` and **without** `ftp://` (e.g. **80.237.222.43**).

When using a *local FTP server*, you need to enter its IP address within the local network and its user name and password assigned by your network administrator. The camera will automatically store the current live or event image as `test.jpg` in the predefined MOBOTIX directory on the FTP server.

If you have filled out the fields on the **Image Transfer to FTP Server** page, you can automatically configure an image transfer to an FTP server on the following page (**Image Storage**).

Image transfer:

- **Scheduled**
- **Event-controlled**

**Quick Installation**  
Image Transfer to FTP Server

The File Transfer Protocol (FTP) is a standard Internet protocol for transferring files from a client (e.g. the MOBOTIX camera) to a server (e.g. the computer where your home page is hosted).

Enter the (symbolic) FTP server name or its IP address and your valid login and password to access the server.

FTP Server IP or Name:

Login Name:

Password:

Images on the FTP server will be stored as **MOBOTIX/test.jpg**

To configure more FTP servers, open **Admin Menu > FTP Profiles**.

**Quick Installation**  
Image Storage

You can control FTP image storage using two different mechanisms. Select the desired configuration:

**Time-controlled image storage**  
An image will be stored every five minutes. Open **Admin Menu > Time Tasks** to change the interval.

**Event-controlled image storage**  
An image will be stored if an event occurs. One video motion (VM) window and the User Click event (UC) have been preset.  
**Hint:** click on the **UC Event** button to create a User Click event.

**Do not configure image storage**

You can define image transfer to be **Time-controlled image storage** or **Event-controlled image storage**. *Time-controlled image storage* creates an FTP profile, which stores a live image as `test.jpg` in the `MOBOTIX` directory on the FTP server every five minutes.

*Event-controlled image storage* transfers an event image to the FTP server when the camera detects a movement in the motion detection window of the live image (dotted frame) or when the **UC Event** button on the camera's user interface is clicked in the browser (factory default). Your `MOBOTIX` camera automatically creates the required file and directory names.

The FTP profile created by the Quick Installation wizard is stored in **Admin Menu > FTP Profiles** as `FTPQI1` (or `FTPQI2`, etc. for multiple configuration runs using the Quick Installation wizard). Open this dialog to view and modify the stored FTP profiles.

If you would like to skip this step and postpone configuring image transfer via FTP, simply activate the **Do not configure image storage** option.

For more information on image transfer to an FTP server see sections 7.7.2, *FTP File Transmission (FT Action)*, and 7.8.2, *FTP Profiles*.

## Video Codec

Depending on the application, the `MOBOTIX` camera can encode the video images in JPEG or in MxPEG format. MxPEG provides large-format live video at extremely low network loads (1% on a 100 Mbps network) while delivering frame rates of up to 30 frames/sec to a browser window. On top, MxPEG also includes the audio channel from the camera's integrated microphone to the web browser.

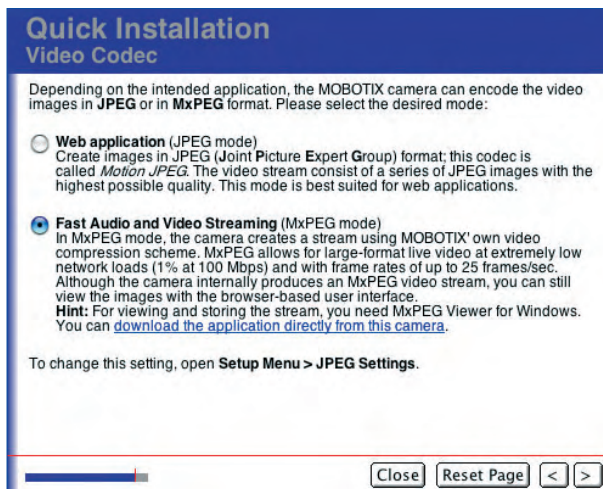

Regardless of the chosen video codec, the live image is displayed in every web browser. If a browser does not support MxPEG (or if ActiveX has not been installed), the camera automatically switches to JPEG. Moreover, the camera can continue storing images in JPEG format (e.g. on a web server using FTP) even though it is running in MxPEG mode.

- **Web Application (JPEG Mode):** The camera creates the images in JPEG (Joint Picture Expert Group) format; this codec is called *Motion JPEG*. The video stream consists of a series of JPEG images with the highest possible quality. This mode is best suited for web applications.

The **Admin Menu** allows setting the options for image transfers (**FTP Profiles, Time Tasks**)



**MxPEG mode** for high-resolution live video with low bandwidth requirements

**JPEG mode** for Web applications

- **Fast Audio and Video Streaming (MxPEG Mode):** In MxPEG mode, the camera creates a stream using MOBOTIX video compression.

The MxPEG concept



### Note

The setting made here is only valid for the **display of the live images** in the web browser. It has very little influence on the format of images that are stored on e.g. an FTP server or an external file server (MxPEG may cause image "tiles"). Open **Admin Menu > FTP Profiles, Admin Menu > E-Mail Profiles** or **Setup Menu > Recording** (for recording events) to set the format of the stored images/video clips.

### Storing the Configuration

This page contains an overview of the most important settings.

**Hint:** Print this page for documentation purposes *prior* to storing the configuration.

Check the data and save the configuration by clicking on **Store Configuration**.

If you would like to keep the old settings, you can cancel the entire process without saving the configuration by clicking on **Close**. Click on the left pointed bracket (" $\leftarrow$ ") if you would like to return to one of the previous pages of the Quick Installation wizard to change settings.

Once you have saved the configuration, reboot the camera for the new settings to take effect.

Please note that the new network settings will be in effect after rebooting. If you have changed the camera's IP address, you can access the camera using this new IP address after rebooting. The original factory default IP address (see sticker on the camera case) will no longer be valid.

Once you have changed the administrator password, you can only login to the Admin menu using the new password.

Overview of the configuration parameters

### Quick Installation

#### Store Configuration

<b>Users and Passwords</b>	
Users and passwords will not be changed	
<b>Ethernet (LAN) On</b>	
IP address	10.1.14.190
Network Mask	255.0.0.0
<b>Routing configured</b>	
Default Route	ISDN Dial-Out
Network Route	not configured
<b>ISDN Dial-Out On</b> for user arcor-basis	
Phone Number	0192077
<b>ISDN Dial-In On</b> for user linux	
Camera MSN	123456
IP Address	10.1.14.190
<b>ISDN Phone Call-In On</b>	
Camera MSN	123456
<b>ISDN Phone Call-Out configured</b>	
Phone number	06313033100

If you are satisfied with this configuration, press **Store Configuration**. Otherwise, go back to the corresponding page and change the configuration.

Close Print Page  $\leftarrow$  Store Configuration

**Rebooting the camera**

Click on the **Reboot** button to reboot the camera with the modified settings.

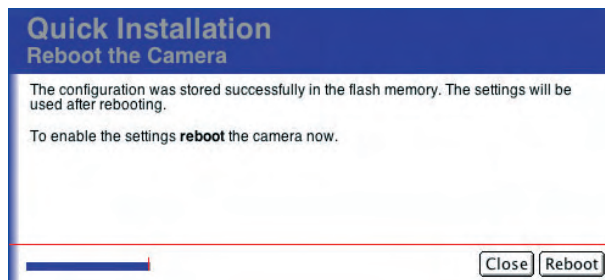

Click on the **Close** button to cancel the Quick Installation wizard without making any changes. If you do this, open the Quick Installation wizard again and complete it to make sure that the camera will not use the wrong settings after rebooting.

Settings are only active after rebooting the camera

**Note**

If you find that you cannot reach the camera after rebooting, start the camera with its factory defaults (see section 3.6, *Starting the Camera Using the Factory IP Address*, in the *Camera Manual*).

While rebooting, the camera's new configuration parameters are displayed on the **Waiting for the Camera to Reboot** page. Once the camera has rebooted successfully, the dialog closes automatically and displays the camera user interface in the browser.

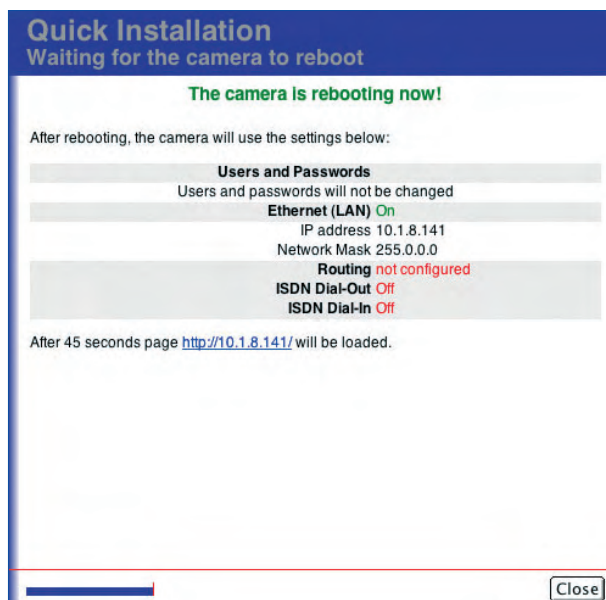

Make sure all settings are correct



### 5.3 Connection Test

The MOBOTIX camera displays an overview of the active interface and the configured profiles (FTP, e-mail, IP Notify) in the **Admin Menu > Test Current Network Configuration** dialog. This is a centralized and easy-to-use collection of tests for checking all settings and profiles of this camera. For some of the tests, the camera uses **ping** commands to check connections or RAS results (FTP, e-mail, IP Notify network messages).

Always run the network tests from top to bottom

Result:  
Green = OK  
Red = error

Connections	Configuration	Test	Result
Ethernet (LAN)	Configuration by DHCP. IP address: 192.168.0.26 Network mask: 255.255.255.0 Broadcast: 192.168.0.255 MAC address: 00:03:C5:01:0E:BE		OK
ISDN Dial-Out			Not configured
Routing	Configuration	Test	Result
Default Route	Gateway: 192.168.0.254 Connection: Ethernet interface	<input type="button" value="Connect"/>	Untested
Network Services	Configuration	Test	Result
DNS Server	192.168.0.254 192.168.0.99	<input type="button" value="Connect"/>	Untested
Resolver	This test tries to find the IP address of <i>www.mobotix.com</i> .	<input type="button" value="Resolve"/>	Untested
Image Transfer	Configuration	Test	Result
FTP Profile 'FTP-Webcam'	Host: ftp.myhome.test User name: my_user Password: my_pass Path: webcam/current.jpg	<input type="button" value="Transfer"/>	742 kBytes written in 6 secs / transferrate is: 123.7 KByte/s (1 file)
FTP Profile 'FTP-AlarmClip'	Host: ftp.myhome.test User name: my_user Password: my_pass Path: alarm/M10-1-14-190/2005-07-18/m050718144158461.mxd	<input type="button" value="Transfer"/>	46 kBytes written in 1 secs / transferrate is: 46.0 KByte/s (1 file)
E-Mail Profile 'AlarmMail'	Server: smtp.myhome.test Sender (from): M10-1-14-190@myhome.test Recipient (to): someone@myhome.test	<input type="button" value="Transfer"/>	Untested
IP Notify	Configuration	Test	Result
IP Notify Profile 'HttpPostSysMsg24'	Destination Address: 10.0.62.15:8000 Message: Hello World! I'm M10-1-14-190 with event 0.	<input type="button" value="Send"/>	Untested
IP Notify Profile 'HttpRequest'	Destination Address: localhost:80 Message: action=ledson&leds=BBBBBB&time=5	<input type="button" value="Send"/>	IP notification succeeded!
IP Notify Profile 'SimpleNotify'	Destination Address: 10.1.0.11:8000 Message: Hello World! I'm M10-1-14-190 with event 0.	<input type="button" value="Send"/>	Untested
IP Notify Profile 'MultipleNotify'	Destination Address: 10.1.0.37:8000 10.1.0.94:8000 Message: Hello there! I'm M10-1-14-190 with event 0.	<input type="button" value="Send"/>	IP notification succeeded!
Miscellaneous	Configuration	Test	Result
General Test	Test this host: <input type="text" value="kamera.mobotixserver.com"/>	<input type="button" value="Connect"/>	Host OK.

Log window does not appear:  
**Popup blocker** deactivated for this IP address?

Upon opening the dialog, the camera also opens the **Network Test Log** for displaying the test results.

You should execute all tests **one by one starting from the top** and carefully analyze the test results. Make sure that the camera has been rebooted after you have changed the configuration, particularly after having modified parameters of the Ethernet, ISDN, file server or DynDNS configurations.

## Available Tests

### a) Connections

- **Ethernet (LAN):** Displays status and data of the Ethernet interface.
- **ISDN Dial-Out:** Tests every defined connection:
  - Is the ISDN line available?
  - Is the called device busy?
  - Are the user name and password for accessing the provider correct?

### b) Routing

- **Network Route:** Displays the status of the defined network route.
- **Default Route:** Checks the connection of the defined default route.

### c) Network Services

- **DNS Server:** Checks the availability of the defined DNS server (Domain Name Service).
- **Resolver:** Checks that the defined DNS server is operating correctly.

### d) Image Transfer and Storage

- **FTP Profile:** Checks the FTP profile by transferring an image to the FTP server.
- **E-Mail Profile:** Checks the e-mail profile by sending an e-mail.

### e) IP Notify

- **IP Notify Profile:** Checks the IP Notify profile by sending a network message to the corresponding computer.

### f) Miscellaneous

- **General Test:** Enter a computer name to see if the camera can reach this computer using the **ping** command.

Kamermodell	
X	-
X	-
-	X
-	X

Kamermodell	
X	-
X	-
-	X
-	X

Kamermodell	
X	-
X	-
-	X
-	X

## 5.4 Basic Settings

### 5.4.1 Users, User Groups, Passwords, Supervisor Mode

MOBOTIX cameras have an integrated **user management**, which is used to create new users and to manage existing ones; it also allows controlling which user groups have access to which camera screens and functions. For example, you can restrict access to the Admin and Setup pages and to individual camera screens; likewise, you can restrict access from MxViewer. On the other hand, you can grant *public access* to specific functions and screens (no user credentials are required to access these camera features).

Similar to a computer operating system, the MOBOTIX camera provides all means to tailor the functionality to the needs of specific user groups. IT administrators, for example, can have unlimited access to all configuration settings, while IT assistants can only access the recording and event settings. A supervisory body could assume the role of the **Supervisor** to schedule access times; this would allow restricting access to stored images to a specific user group or to certain control organs in highly regulated work environments, for instance.

#### Recommended procedure for user and user group management

- If possible, keep the user groups that have been preset in the factory default configuration.
- Create new user groups only if you need other access rights as those configured in the factory default groups.
- Create new users and set the passwords.
- Assign a user group to each user.
- If required, restrict the access rights of specific user groups (**Group Access Control List**).

#### Users and Passwords

Open **Admin Menu > Users and Passwords** to create new users and to delete existing users. This dialog also allows assigning the user groups defined in the **Group Access Control Lists** dialog.

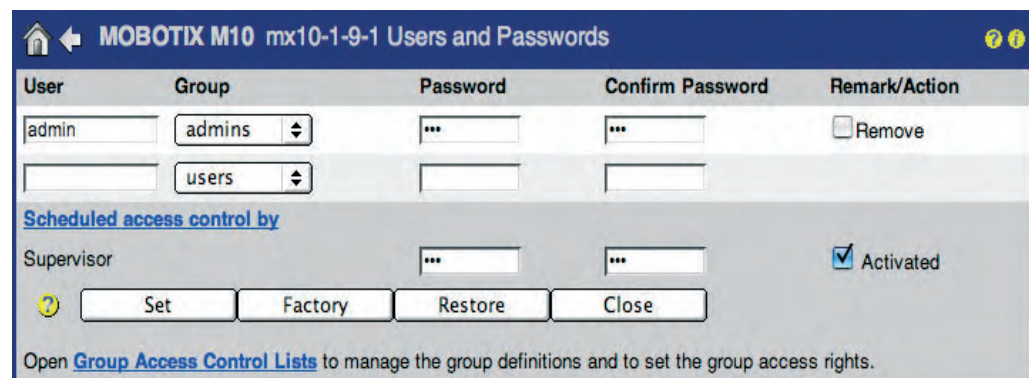

User	Group	Password	Confirm Password	Remark/Action
admin	admins	...	...	<input type="checkbox"/> Remove
	users			

**Scheduled access control by**

Supervisor: ...  Activated

Buttons: Set, Factory, Restore, Close

Open [Group Access Control Lists](#) to manage the group definitions and to set the group access rights.

As per factory default, one user with administrator rights has been set:

- User: **admin**
- Password: **meinsm**

To create a new user, enter a **User Name** and a **Password**. To delete a user, activate the **Remove** checkbox at the end of the corresponding row. Click on the **Set** button (the page refreshes), then on the **Close** button and store the configuration permanently.

Select the desired user group from the **Group** dropdown list. It contains all user groups defined in **Admin Menu > Group Access Control Lists** as well as the *Undefined* group. Users assigned to this group had been assigned to a group that has been deleted in the meantime; these users do not have any access rights. They can be assigned to an existing user group or to a yet-to-be-created user group later on.

- Number of users: **up to 30**
- Length of user name: **3 to 16 characters**
- Length of password: **5 to 8 characters**
- Allowed characters: **"A-Z", "a-z", "0-9", ". " (dot), "-" (hyphen), "\_" (underscore)**

User names and passwords of a MOBOTIX camera are case-sensitive!

**Caution**

**It is strongly recommend that you change the default user name (admin) and the default password (meinsm).** Make sure you store the **admin** user's password in a safe place if you change it—if you forget the new password, there will be **no administrative access** to the camera any more. Resetting the camera to the factory defaults is only possible at the MOBOTIX factory or subsidiary (this service is not free!).

If the admin password has been lost, the camera has to be sent back to MOBOTIX

**User Groups**

Every user has to be assigned to a user group. Open **Admin Menu > Group Access Control Lists** to manage the user groups and the corresponding access rights.

ACL = Access Control Lists

Access Rights	Screen / View					MxViewer	Configuration			Remove Group
	Guest	Live	Player	MultiView	PDA	MxViewer	Admin	Image Setup	Event Setup	
Public Access	<input checked="" type="checkbox"/>	<input checked="" type="checkbox"/>	<input checked="" type="checkbox"/>	<input checked="" type="checkbox"/>	<input checked="" type="checkbox"/>	<input checked="" type="checkbox"/>	<input type="checkbox"/>	<input type="checkbox"/>	<input type="checkbox"/>	Disable all
<b>Groups</b>										
admins	<input checked="" type="checkbox"/>	<input checked="" type="checkbox"/>	<input checked="" type="checkbox"/>	<input checked="" type="checkbox"/>	<input checked="" type="checkbox"/>	<input checked="" type="checkbox"/>	<input checked="" type="checkbox"/>	<input checked="" type="checkbox"/>	<input checked="" type="checkbox"/>	<input type="checkbox"/>
guests	<input checked="" type="checkbox"/>	<input type="checkbox"/>	<input type="checkbox"/>	<input type="checkbox"/>	<input type="checkbox"/>	<input type="checkbox"/>	<input type="checkbox"/>	<input type="checkbox"/>	<input type="checkbox"/>	<input type="checkbox"/>
users	<input checked="" type="checkbox"/>	<input checked="" type="checkbox"/>	<input checked="" type="checkbox"/>	<input checked="" type="checkbox"/>	<input checked="" type="checkbox"/>	<input checked="" type="checkbox"/>	<input type="checkbox"/>	<input checked="" type="checkbox"/>	<input checked="" type="checkbox"/>	<input type="checkbox"/>
	<input type="checkbox"/>	<input type="checkbox"/>	<input type="checkbox"/>	<input type="checkbox"/>	<input type="checkbox"/>	<input type="checkbox"/>	<input type="checkbox"/>	<input type="checkbox"/>	<input type="checkbox"/>	<input type="checkbox"/>

Buttons: Set, Factory, Restore, Close, More

Open [Users and Passwords](#) to manage users and to assign groups.

To create a new user group, enter a group name in the last (empty) field in the **Groups** column. To delete a user group, activate the **Remove Group** checkbox at the end of the corresponding row. Click on the **Set** button (the page refreshes), then on the **Close** button and store the configuration permanently. If users had been assigned to a deleted user group, they will be assigned to the *Undefined* user group.



**admins**, **users** and **guests** are predefined user groups

### Preset Factory Default User Groups:

- **admins**: By factory default, users of this group can execute all functions of the MOBOTIX camera. They have access to the Admin menu and the Quick Installation wizard, the hardware setup, network, ISDN and VoIP settings, FTP and e-mail configurations, all camera screens and they can view the camera from MxViewer, for example. It is not possible to delete this group and there has to be at least one user of the **admins** group.
- **users**: By factory default, users of this group have access to all camera screens, the Setup menu for image and exposure settings as well as event control.
- **guests**: By factory default, users of this group only have access to the Guest screen with the live image and limited frame rates. Accessing the Setup menu or the Admin menu is not possible.

### Public Access

Activate the checkboxes for the **screens/views**, **configurations** and **functions** in the **Public Access** row to make them publicly accessible, i.e. they do not require a user name and password to access them. By factory default, all screens and the functions of the Setup menu are public, whereas access to the Admin menu is not public.

Public access can be blocked completely (see section *Making a MOBOTIX Camera Secure*)

For security reasons, access to the Admin menu cannot be made public. This is only possible for users of an existing group. This prevents situations where the administration area of a MOBOTIX camera would become publicly accessible (i.e. without entering a user name and password).

Access Rights	Screen / View					Configuration			Disable all	
	Guest	Live	Player	MultiView	PDA	MxViewer	Admin	Image Setup		Event Setup
Public Access	<input checked="" type="checkbox"/>	<input checked="" type="checkbox"/>	<input checked="" type="checkbox"/>	<input checked="" type="checkbox"/>	<input checked="" type="checkbox"/>	<input checked="" type="checkbox"/>	<input type="checkbox"/>	<input type="checkbox"/>	<input type="checkbox"/>	Disable all

Note that the screens and functions activated in the **Public Access** row take priority over the settings of individual user groups. If public access has been activated for the **Live** screen, users of the **guests** group also have access to this screen although the **Live** screen has been deactivated for the **guests** group.

#### Note

Note that the screens and functions activated for public access take priority over the settings of individual user groups. To be able to change the setting of such a function, deactivate the corresponding checkbox in the **Public Access** row.

**Access Rights of the User Groups**

Use the checkboxes of the individual user groups to set the desired access rights. Gray checkboxes cannot be changed as they are locked. The functionality activated or deactivated by this checkbox is either required or it has already been activated in the **Public Access** row.

Changing the access rights of individual user groups

The following screens and functions can be configured individually:

- **Screen/View**

This section controls the access rights of the camera screens, which are to be accessible or restricted for the individual user group. The section comprises all screens of the MOBOTIX camera (including the MultiView and PDA screens). For more information on the screens of the camera, see chapter 4, *Camera User Interface*.

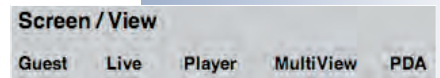

- **MxViewer**

Activating the **MxViewer** right means that the members of this group can use MxViewer for viewing the camera and for receiving its alarm messages. For more information on MxViewer, see also chapter 4, *Camera User Interface*.

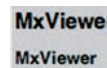

- **Configuration**

This section controls the access rights of the configuration areas, which are to be accessible or restricted for the individual user group.

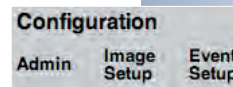

- **Administration** (Admin Menu)
- **Image Settings** (Setup Menu)
- **Event Settings** (Setup Menu)

If the **Events** access right has not been activated for a user group, the members of this group will not be able to activate or deactivate any events, they will not be able to configure actions or messages and they cannot change the settings that control the arming and the recording of the camera.

- **Function**

Click on the More **button** to display this section. This section lists the functions that should be activated for the corresponding camera screen. **Info**, **Guest Image**, **Live Image**, **Image Link**, **Events**, **API (QC, SB)** (Quick Controls, Softbuttons).

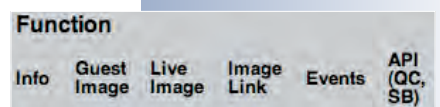

### How the Group Access Control List Works

In order to access a screen of the MOBOTIX camera, you need to have access to certain functions of the camera software.

Screen / View					
Access Rights	Guest	Live	Player	MultiView	PDA
Public Access	<input checked="" type="checkbox"/>	<input type="checkbox"/>	<input type="checkbox"/>	<input type="checkbox"/>	<input type="checkbox"/>

Function					
Info	Guest Image	Live Image	Image Link	Events	API (QC, SB)
<input type="checkbox"/>	<input checked="" type="checkbox"/>	<input type="checkbox"/>	<input type="checkbox"/>	<input type="checkbox"/>	<input type="checkbox"/>

Screen / View					
Access Rights	Guest	Live	Player	MultiView	PDA
Public Access	<input type="checkbox"/>	<input checked="" type="checkbox"/>	<input type="checkbox"/>	<input type="checkbox"/>	<input type="checkbox"/>

Function					
Info	Guest Image	Live Image	Image Link	Events	API (QC, SB)
<input checked="" type="checkbox"/>	<input type="checkbox"/>	<input checked="" type="checkbox"/>	<input type="checkbox"/>	<input type="checkbox"/>	<input checked="" type="checkbox"/>

For viewing the **Guest** screen, for example, access to the `/cgi-bin/guestimage.html` web page is necessary. The camera, however, uses other script features to properly display this screen. For one thing, the Guest screen has to be activated (**Screen/View** section, **Guest** checkbox), but also the required functions (**Function** section, **Guest** checkbox). Hence, when activating the **Guest** screen, the **Guest** function will be activated automatically. The latter checkbox cannot be deactivated as long as the **Guest** screen has been activated, since this function is required for properly showing this screen.

For viewing the **Live** screen, on the other hand, access to the `/cgi-bin/userimage.html` web page is required. This page also uses other script features to properly display this screen. For one thing, the Live screen has to be activated (**Screen/View** section, **Live** checkbox), but also the required functions (**Function** section, **Live Image** checkbox). Hence, when activating the **Live** screen, the **Live Image** function will be activated automatically. The latter checkbox cannot be deactivated as long as the **Live** screen has been activated, since this function is required for properly showing this screen.

The functions required to make the Live screen fully accessible will be activated automatically (**Info** und **API (QC, SB)**), but they can be deactivated (in contrast to the **Live Image** function) as they are not required for displaying the Live screen itself (Info button in the top right corner as well as the Quick Controls and the softbuttons). You may want to deactivate these two rights, e.g. if a user must not see the camera status information and must not use the softbuttons on the Live screen.

For the **MultiView** and **PDA** screens, no other rights but **Live Image** are necessary, whereas **MxViewer** uses all functions (including Live Image). Since the required functions strongly depend on how they will be used (e.g. by **MxViewer**), all functions can be set individually for the screens and for MxViewer.

### Making a MOBOTIX Camera Secure

By factory default, most of the camera's screens and functions are publicly accessible, i.e. they do not require a user name and password to access them. Once users enter the camera's IP address, they can access the **Guest** and **Live** screen of that camera, provided it still has the factory default configuration. A yellow warning in the **Users and Passwords** dialog informs you of this situation.

In order to **fully protect the MOBOTIX camera from unauthorized access**, you should perform the following steps:

- Reset the configuration to factory defaults, if feasible. This resets all users, passwords and group access rights to the factory default values.

Block the camera from public access!

**CAUTION: Resetting to factory defaults in Admin Menu > Group Access Control Lists will reset the admin user password to the factory default meinsm; all other users will be deleted!**

- Make sure that you change the password for the **admin** user.

User	Group	Password	Confirm Password	Remark/Action
admin	admins	...	...	<input type="checkbox"/> Remove
	undefined			

**Scheduled access control by**

Supervisor: ...  Activated

**Caution: Some areas of the camera are still publicly accessible.**  
 Activate the checkbox below and click **Set** to prevent access to the camera without proper user authentication.

Disable public access

Buttons: Set, Factory, Restore, Close

Open [Group Access Control Lists](#) to manage the group definitions and to set the group access rights.

- Deactivate public access for all functions and screens (activate the **Disable public access** checkbox).
- Create the required user groups and set the access rights as desired.
- Create the users and assign a user group to each user.
- Click on the **Set** button (the page refreshes), then on the **Close** button and store the configuration permanently.

To see who actually accessed the camera, you might want to examine the web server log files, which are accessible in **Admin Menu > WEB Server Logfile**.

#### Note

If **MxViewer has not been activated** for a group or for public access, MxViewer may still be able to access the camera. This is the case if other screens have activated the functions required by MxViewer, for example. **In order to prevent a group from accessing the camera using MxViewer, make sure to deactivate all checkboxes in the Functions section of this group.**

Unsecured camera with warning

Preventing unauthorized access of a MOBOTIX camera



Activate scheduled access control:  
Activate **Supervisor**

Protecting employee privacy

### Scheduled Control of Access Rights (Supervisor)

For special situations, the predefined **Supervisor** user can restrict group access rights to certain times or even completely. This approach allows defining time slots for specific user groups, which are then allowed to access the corresponding functions and screens of the camera. It is also possible to restrict the access rights of users with administrator privileges, e.g. to make the microphone features or playing back recorded video streams available only at specific times or for a certain duration. As a general rule, an administrator manages user access rights and users, while the Supervisor controls the access schedule.

As an **example of this feature**, we could think of the surveillance cameras of a production site. The IT department (*admins*) and the worker's council (*Supervisor*) of the company have agreed that camera administration would only be allowed if at least one member of each party would be present. To make changes to the configuration, individual cameras would be accessible for a certain time every week, e.g. Friday between 2 pm and 3 pm, or upon request. Changes to the configuration would be possible only within this timeframe; members of the worker's council have to be present to prevent any abuse of this rule.

To start with, a user with administrator privileges has to activate the Supervisor feature. Open **Admin Menu > Users and Passwords** and perform the following steps:

User	Group	Password	Confirm Password	Remark/Action
admin	admins	...	...	<input type="checkbox"/> Remove
	users			

**Scheduled access control by**

Supervisor	...	...	<input checked="" type="checkbox"/> Activated
------------	-----	-----	---

Open [Group Access Control Lists](#) to manage the group definitions and to set the group access rights.

- Enter a valid password for the Supervisor in the **Scheduled access control by Supervisor** section and again in the **Confirm Password** field (length has to be between 5 to 8 characters).
- Activate the **Activated** checkbox.
- Click on the **Set** button (the page refreshes), then on the **Close** button and store the configuration permanently.

#### The Supervisor has now been activated.

- Open the **Admin Menu > Users and Passwords** dialog again and click on the **Scheduled access control by** link.
- Enter the user name (**Supervisor**) and the password.

Activating the Supervisor

User name: **Supervisor**

The **Scheduled Access Control** dialog opens:

**MOBOTIX M10 mx10-1-9-1 Scheduled Access Control**

**Global Rule**

Group	Access	From: year - month - day, hour (0..23) : minute	To: year - month - day, hour (0..23) : minute
All Groups	<input type="radio"/> Deny access <input type="radio"/> Allow access <input type="radio"/> Allow scheduled access from: [ ] - [ ] - [ ] , [ ] : [ ] to: [ ] - [ ] - [ ] , [ ] : [ ] from now for [ ] minutes		
<input checked="" type="radio"/> Allow access as set in Individual Group Rules below			
<b>Individual Group Rules</b>			
Group	Access	From: year - month - day, hour (0..23) : minute	To: year - month - day, hour (0..23) : minute
admins	<input type="radio"/> Deny access <input checked="" type="radio"/> Allow access <input type="radio"/> Allow scheduled access from: [ ] - [ ] - [ ] , [ ] : [ ] to: [ ] - [ ] - [ ] , [ ] : [ ] from now for [ ] minutes		
guests	<input type="radio"/> Deny access <input type="radio"/> Allow access <input checked="" type="radio"/> Allow scheduled access from: [ ] - [ ] - [ ] , [ ] : [ ] to: [ ] - [ ] - [ ] , [ ] : [ ] from now for 4 days		
users	<input type="radio"/> Deny access <input type="radio"/> Allow access <input checked="" type="radio"/> Allow scheduled access from: 2006 - 03 - 09 , 00 : 00 to: 2006 - 03 - 15 , 23 : 59 from now for [ ] minutes		

**Supervisor Status and Password**

Supervisor  Activated New Password: \*\*\* Confirm New Password: \*\*\*

Set Factory Restore Close

Scheduled access control by the *Supervisor*

Access can be controlled for individual groups

Note that the **Supervisor** can only be deactivated by the Supervisor him/herself. Likewise, changing the password is only possible for the Supervisor. This always requires entering the old Supervisor password. To deactivate the Supervisor feature, open the **Scheduled Access Control** dialog, **Supervisor Status and Password** section:

- Deactivate the **Activated** checkbox.
- Click on the **Set** button.

**The Supervisor has now been deactivated.**

Deactivating the Supervisor will void the password; the **Scheduled Access Control** dialog is not accessible any more. Only a user with administrator privileges can activate the Supervisor feature again later on in the **Admin Menu > Users and Passwords** dialog.

Deactivating the Supervisor

#### Note

The **Scheduled Access Control** dialog is not accessible by other users, not even for users with administration privileges. This page is only accessible if the Supervisor has been activated:

- **http://<IP address>/admin/supervisor**
- User name: **Supervisor**

The **Supervisor** user name is preset and cannot be changed

Deactivating the Supervisor feature can also be performed in **Admin Menu > Users and Passwords**, but this also requires administrator access rights (on top of the Supervisor rights and the corresponding password), whereas administrator privileges are not required if the Supervisor him/herself deactivates this feature.

**Example for Scheduled Access of a User Group**

Create the **test-users** group

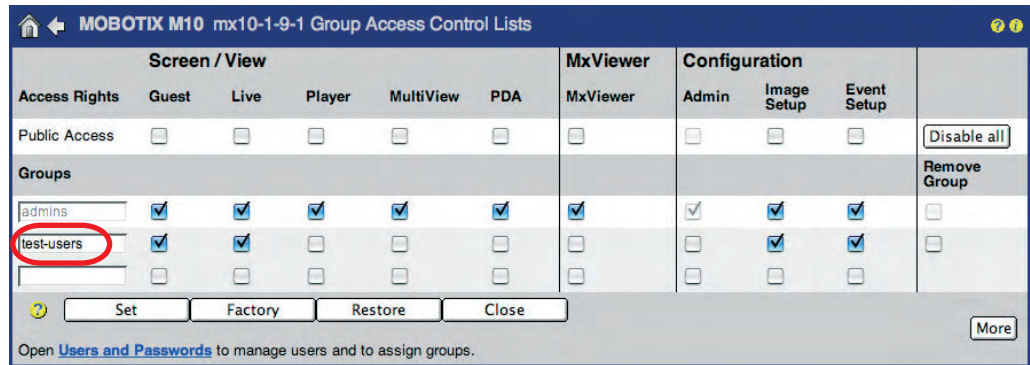

Create the **test-user** and assign it to the **test-users** group

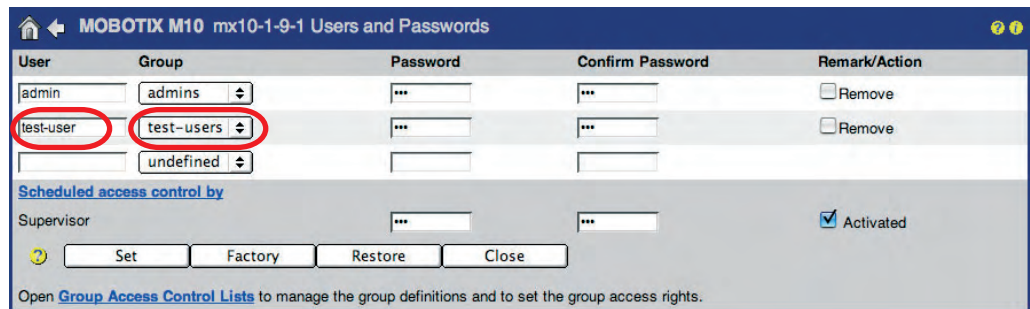

Assign the rights of the individual user groups

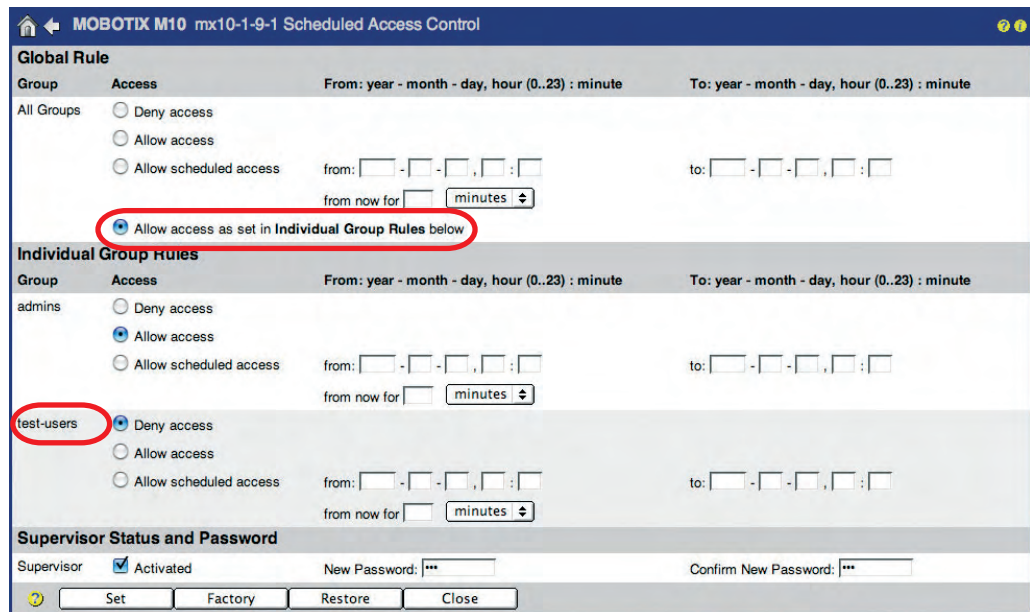

Set the access times for the **test-users** group

In the **Scheduled Access Control** dialog, set the access rights for all user groups in the **Global Rules** section. The **Group Rules** section allows setting individual options for the individual user groups (**test-user** in the **test-users** group in our example).

The settings of the **Global Rules** section take priority over the settings of individual group rules as set in the **Group Rules** section. If you would like to use the group rules, select the **Allow access as set in Individual Group Rules below** option in the **Group Rules** section.

**You can set the following options to restrict camera access:**

- **Deny access:**  
This user group never has access.
- **Allow access:**  
This user group always has access.
- **Allow scheduled access from ... to ...:**  
Use this option if you would like to set the start and end times of the period during which access is granted for this group. Note that the start time can also be in the past. The end time has to be at least three minutes in the future, but may not be in the future for more than a year (365 days). Enter the times as `Year-Month-Day-Hour:Minute`.  
The **from now for ...** allows setting a duration in *minutes*, *hours* or *days* during which access is granted. The time starts counting as soon as you click *Set*; the end time is computed from the duration you entered.
- **Allow access as set in Individual Group Rules below:**  
Activate this option if you would like to configure the scheduled access individually for specific groups. Set the scheduled access for each user group listed in the **Group Rules** section.

#### Caution

Make sure you store the Supervisor password in a safe place if you change it—if you forget the password, there will be **no possibility** to get into the Supervisor area any more. Not even a member of the **admins** group can deactivate the Supervisor feature without knowing the Supervisor password. If the **admins user group** has been blocked from accessing the camera, the camera has to be sent back to MOBOTIX. Resetting the camera to the factory default settings is only possible at MOBOTIX or one of its subsidiaries (this service is not free!).

Global rules are valid for all user groups, group rules only for the corresponding user group



### 5.4.2 Date and Time / Time Zones and Time Server

The MOBOTIX camera has a real-time clock that is buffered by a rechargeable battery, making it independent of the actual camera power supply. When booting, the camera operating system's clock is synchronized with the real-time (hardware) clock and again every 6 hours.

Set Clock to	Explanation
Date: 2006 - 05 - 22	Enter the date as <i>year - month number - day number</i> .
Time: 11 : 41 : 18 CEST [Set]	Enter the time as <i>hour : minute : second</i> , use local time.
Your Computer: Monday, 22 May, 2006 11:32:18 AM GMT+2 [Set]	Set the camera time to match the time of your computer.
Parameter Value	Explanation
Time Zone: Europe/Berlin [v]	Select your local time zone.
Time Server: 130.149.17.9	Enter the host name or IP address of the time server. <b>Note:</b> The time server must be reachable over the network.
Time Protocol (RFC 868) [v]	Select the protocol that your time server uses. Choose either <i>Time Protocol (RFC 868)</i> for a simple time protocol using port 37 or choose <i>NTP (RFC 1305)</i> if you want to use the more advanced Network Time Protocol.
<input type="checkbox"/> Adjust periodically	If <i>Adjust periodically</i> is enabled, the clock will be adjusted to the time server periodically.
Hourly Sound: - no chime - [v]	Select a sound file if you want the camera to chime every hour.

[Set] [Factory] [Restore] [Close]

#### Date and Time

Open the **Admin Menu > Time and Date** dialog to change the camera's date, time and time zone settings (e.g. *Europe/London* for the U.K.).

#### Time Server

To prevent the real-time clock from deviating from the actual time, you can use a time server to periodically get the precise time. The time server used for synchronizing the clock can be on the Internet, on your local network or it can be another MOBOTIX camera. This provides for easy and reliable synchronization of larger installations with several cameras. Two protocols are available for synchronizing the real-time clock of the MOBOTIX camera with a time server:

- **NTP, Network Time Protocol (RFC 1305)**  
When using NTP, the camera will **synchronize the clock on an ongoing basis** using one or more NTP time servers on the Internet (e.g. `time.nist.gov` or `ptptime1.ptb.de`).
- **Time Protocol (RFC 868)**  
When using Time Protocol, the MOBOTIX camera will automatically synchronize the clock when booting and **then again every six hours**.

#### Recommendation:

- **NTP (RFC 1305)** is recommended for cameras with a permanent network connection.

#### Advantages of NTP:

- High degree of precision of the camera's internal clock.
- Time differences are reduced to a minimum.

The MOBOTIX camera's real-time clock can be synchronized using a time server

NTP time server only on the local network!

- NTP allows using the camera as a time server for other MOBOTIX cameras (see below under *Automatic Time Synchronization with a MOBOTIX Camera*).
- **Time Protocol (RFC 868)** should only be used for cameras that use an ISDN Dial-Out connection to access the time server.

#### Note

Automatic synchronization with the time server will only be performed, if **Adjust periodically** has been activated. The camera has to be able to access the time server using the local network or an ISDN connection.

#### Caution

Note that a MOBOTIX camera with a configured ISDN dial-out connection (or default route set to ISDN) will try to establish an ISDN data connection for every periodic synchronization. When using an external RFC 868 time server, this will happen at every reboot and again every six hours; using an external NTP time server (RFC 1305) will open a permanent connection to the Internet. This may very quickly fill up the camera's automatic dial-out limits (**Admin Menu > ISDN Connections > Dial-Out Parameters**).

If one of the counters exceeds the limits, dial-out is blocked for the rest of the day/week/month, respectively, and the camera will not send any images or messages any more.

In case you have deactivated the dial-out limits, the camera may incur high costs as it is trying permanently to establish dial-out connections. MOBOTIX recommends to use periodic time server synchronization with due caution and—if required, to make sure to have flat-rate Internet access or a time server on the local network, which synchronizes with another (external) time server.

Keep an eye on the ISDN Dial-Out limits

Kamerasmodell	
X	-
X	-
-	X
-	X

Time synchronization  
using **NTP**

## Periodic Time Synchronization with a Time Server on the Internet or a Local Network

### NTP (RFC 1305)

- Enter the IP addresses of up to three **Time Servers** in the corresponding fields.  
You can also use the symbolic names of the time servers (e.g. **time.nist.gov** or **ptptime1.ptb.de**). Make sure that the MOBOTIX camera has access to a valid DNS server for this to work.
- Activate the **Adjust periodically** checkbox.
- Click on the **Set** button at the bottom of the dialog.
- Click on the **view** link to see the output of the camera's NTP client. The information is displayed in different colors: If the time server can be reached, the NTP client output is amber; if the camera clock is synchronized, it is green.  
Note that synchronizing with NTP can take quite some time, sometimes up to 30 minutes (this is also true when rebooting or after clicking the **Set** button).

Time synchronization  
using **Time Protocol**

### Time Protocol (RFC 868)

- Enter the IP address of one **Time Server** providing Time Protocol in the corresponding field.  
You can also use the symbolic name of a time server (e.g. **time.nist.gov** or **ptptime1.ptb.de**). Make sure that the MOBOTIX camera has access to a valid DNS server for this to work.
- In the **Time Server** line of the **Set Clock to** section, click on the **Set** button. If an error message is displayed at the bottom of the dialog, check the IP address or the name of the time server; if they can be reached, make sure that the DNS server can be reached (**Admin Menu > Ethernet Interface**).  
Note: The **Time Server** row and the **Set** button of that row are only available if **Adjust periodically** has *not* been activated.
- Activate the **Adjust periodically** checkbox.
- Click on the **Set** button at the bottom of the dialog.

## Periodic Time Synchronization with a MOBOTIX camera on the Local Network

### Using the MOBOTIX Camera as a Time Server for Other Cameras

- Activate the NTP time server feature of the MOBOTIX camera (*NTP (RFC 1305)* option).
- Enter the **IP address 127.127.1.0** in one of the Time Server fields of the MOBOTIX time server camera.
- Activate the **Adjust periodically** checkbox. This will start the camera's NTP service (client and time server).
- This camera can now work as a time server for other MOBOTIX cameras.  
Note: You should enter at least one "real" NTP time server so that the "time server" camera can synchronize its clock with the external time server.
- Click on the **view** link to see the output of the camera's NTP client. The information is displayed in different colors: If the time server can be reached, the NTP client output is amber; if the camera clock is synchronized, it is green.  
Note that synchronizing with NTP can take quite some time, sometimes up to 30 minutes (this is also true when rebooting or after clicking the **Set** button).

### Synchronizing a MOBOTIX Camera with the Time Server Camera

- Activate the NTP time server feature of the MOBOTIX camera (*NTP (RFC 1305)* option).
- Enter the IP address of the MOBOTIX time server camera in the **Time Server** field.
- Activate the **Adjust periodically** checkbox.
- Click on the **Set** button at the bottom of the dialog.
- Click on the **view** link to see the output of the camera's NTP client. The information is displayed in different colors: If the time server can be reached, the NTP client output is amber; if the camera clock is synchronized, it is green.  
Note that synchronizing with NTP can take quite some time, sometimes up to 30 minutes (this is also true when rebooting or after clicking the **Set** button).



### 5.4.3 LED Signals and LED Configuration

Depending on the camera type, MOBOTIX cameras have six, four or two LEDs, which use blinking, flashing and permanent light to signal certain status or other information of the camera or its sensors.

Open **Admin Menu > LED Setup and Setup Menu > General Event Settings > Event LED Setup** to activate, deactivate or configure the LEDs according to your needs.

#### LED Signal Types (M12/D12)

- **On:** LED is always on
- **Off:** LED is always off
- **Blink:** LED is always blinking
- **Flash:** LED is always flashing (blinking fast)

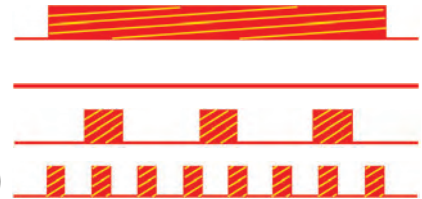

M12/D12 LED Signals

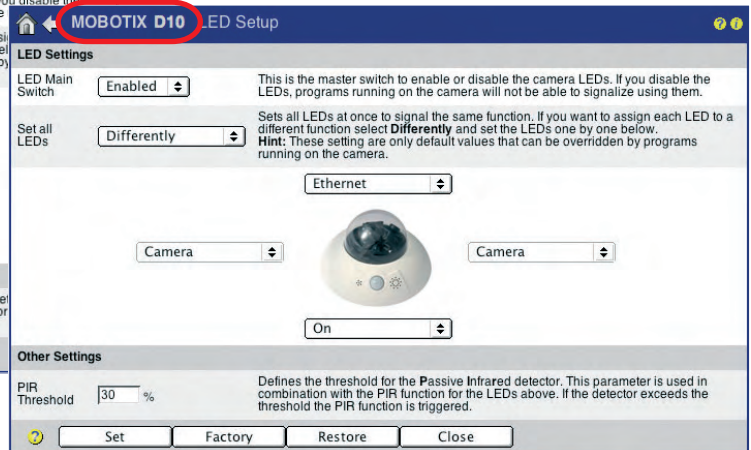
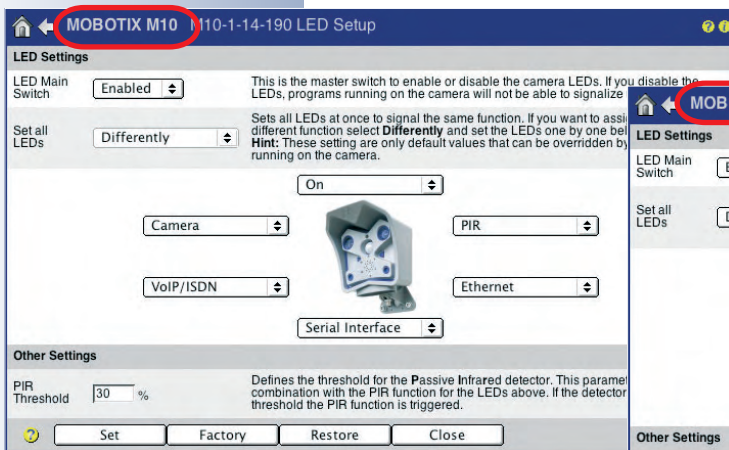

M12/D12

#### Factory Default LED Signals (M12/D12)

As per factory default, the LEDs have been activated (**LED Main Switch: Enabled**, **Set all LEDs: Differently**) and certain signals have been preset. Using the **Set all LEDs** parameter allows setting all LEDs to the same status with only one click.

The following signals have been preset by factory default:

- **On/Power**

The On/Power LED serves as Power On indicator of the camera. The LED is on permanently if the camera's power supply has been connected and the camera is ready.

On/Power LED

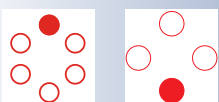

M12 D12

- **Camera**

The camera LEDs flash with every image obtained from the image sensor, i.e. they usually flash very fast. If they are flashing in a slower rhythm, the image sensor delivers a lower frame rate, e.g. when exposure times are long. In addition, the two LEDs will start *blinking* when the camera records and stores images. You can change this behavior in **Setup Menu > General Event Settings** (see below: *Event/Image Processing*).

- **Network/Ethernet**

The network LED (above the 10BaseT socket of M12 models) will show short periodic flashes if a LAN connection exists. The LED is on as long as data is being transferred via the network interface.

- **VoIP/ISDN**

**ISDN operation:**

The VoIP/ISDN LED will show short periodic flashes if an ISDN connection is active. This is the case, for example, if an active ISDN (S0) bus is connected to the camera and control data is exchanged. If an image is transferred via ISDN, the LED will stay ON until the transfer has been completed, i.e. for a longer period of time.

**VoIP operation:**

When using VoIP, the LEDs signals have the following meaning:

- **LED flashes once per second:** VoIP has been set up.
- **LED flashes twice per second:** Camera has been successfully registered with SIP server.
- **LED flashes four times per second:** Error (e.g. SIP server cannot be reached).

**Voice connection is active (VoIP or ISDN):**

If a voice connection has been established via the VoIP (SIP) or ISDN interface, the LEDs signals have the following meaning:

- **LED is always on:** Listen or Speak is active.
- **The lower three LEDs are on (M12):** The camera's speaker is active and plays back the sound from a voice connection (the camera "speaks").
- **The upper three LEDs are on (M12):** The camera's microphone is active and sends back the sound from camera microphone (the camera "listens").

- **Serial Interface/RS232**

The RS232 LED will show short periodic flashes if a serial interface connection is active. This is always the case if the hardware handshake line (DSR, pin 6) is active. If data is transferred via the serial interface, the LED is on while data is being transferred.

**Camera LEDs (Event)**

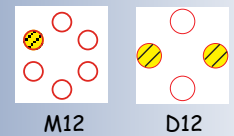

M12

D12

**Network LED**

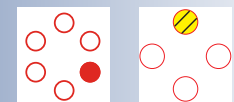

M12

D12

**VoIP/ISDN**

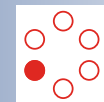

M12

**RS232**

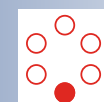

M12

**Caution**

If deactivated (LED Main Switch), the LEDs blink only when the camera is starting. Beyond that, the LEDs will not signal anything.

Camera Model	LED
X	-
X	-
-	X
-	X

**active**=0 V on input or loop to GND closed

**active**=loop to ground is closed

### Additional LED Signals (M12/D12)

In addition to the factory defaults, you can set up the following signals for LEDs:

- PIR**  
 The LED lights up for three seconds if the PIR sensor detects movements (the **Passive Infrared Detector** event does *not* have to be activated in the event settings).
- IR remote control**  
 The LED lights up for three seconds if the camera receives an IR signal from a remote control. The **IR Remote Control** event does *not* have to be activated in the camera software.
- Left button**  
 The LED lights up when **L** key has been pressed.
- Right button**  
 The LED lights up when **R** key has been pressed.
- Signal Input**  
 The LED lights up when the signal input is active (0 Volt at the input or connection to ground). The **Signal Input** events do *not* have to be activated in the camera software.
- Signal Output**  
 The LED lights up when the signal output is active (output switches to ground).
- Event/Image Processing**  
 An LED set to *Event* lights up, flashes or blinks when the camera software detects and processes one of the events selected in the event settings. The behavior of the LED can also be influenced in **Setup Menu > General Event Settings (Event LED Setup** parameters).

Change the **Set all LEDs** parameter to *Default* and click on the **Set** button to reset the LED configuration to the factory default settings.

### Factory Default LED Signals (M22M)

As per factory default, the LEDs have been activated (**LED Main Switch: Enabled, Set all LEDs: Differently**) and certain signals have been preset.

### LED Signal Types (M22)

- On:** LED is always on
- Off:** LED is always off
- Slow blinking:** LED is blinking slowly (1Hz)
- Fast blinking:** LED is blinking fast (4Hz)



M22M LED Signals

- **Positive flashing:** LED is off, flashes on
- **Negative flashing:** LED is on, flashes off



The following signals have been preset by factory default:

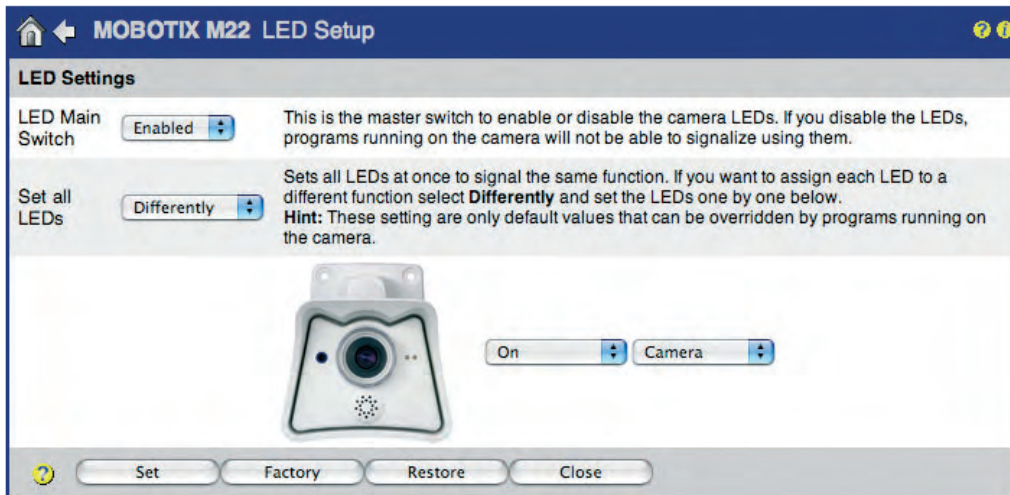

### Green LED (left)

- **On/Power:** The green LED is **on** permanently if the camera's power supply has been connected and the camera is ready.
- **Network/Ethernet:** The green LED will show **fast blinking** if a LAN connection is active. The LED is active as long as data is being transferred via the network interface.
- **VoIP:** The green LED will show **negative flashing** if the camera has successfully registered with the SIP server.
- **Web Server/Network Access:** The green LED will show **positive flashing** while the camera web server is active (i.e. the camera is being accessed from a browser) or the images are viewed using MxViewer or any other application.

### Red LED (right)

- **Event/Image Processing:** The red LED **blinks slowly (1Hz)** when the camera software detects and processes one of the events selected in the event settings. The behavior of the LED can also be influenced in **Setup Menu > General Event Settings (Event LED Setup parameters)**.
- **FTP, E-Mail, SIP Error:** If the red LED **blinks fast (4Hz)**, the camera has detected an error during FTP file transfer, while sending an e-mail or has detected a SIP error (e.g. the SIP server could not be reached).

### Red and Green LED Simultaneously

- **File server connection problem, serious errors:** Both LEDs will **blink slowly (1Hz)** if the camera detects a serious error, e.g. connection problems to the external file server.



Signals of the camera LEDs:

- 0 On/Power
- 1 Event/Image



### 5.4.4 Language and Entry Page

#### Language

The user interface language of the MOBOTIX camera is usually set during the **Quick Installation**; it can also be changed later on in the **Admin Menu > Language and Entry Page** dialog.

The following **language versions** are available as a free software downloads on [www.mobotix.com](http://www.mobotix.com):

- English/German, English/French, English/Italian, English/Spanish, English/Japanese, English/Chinese (in preparation)

Page Options

Language: en Select the language for the dialogs and the user interface.

Image Pull-Down Menus: Show Show (default) or Hide the pull-down menus for image settings on the [Live](#) page.

#### Entry Page

When accessing the IP address of the MOBOTIX camera with factory settings, the camera shows the Live screen. You can set the following screens as start pages in **Admin Menu > Language and Entry Page**:

Select Entry Page

Select	Entry Page	Access	Remarks
<input type="radio"/>	<a href="#">Guest</a>	guest	Only shows the current live image with reduced frame rate. No access to administrative or camera setup functions.
<input checked="" type="radio"/>	<a href="#">Live</a>	user	Live images with menus for changing image parameters and function keys. Access to administrative functions (password-protected).
<input type="radio"/>	<a href="#">Player</a>	user	Play back event images or image sequences using video recorder-like buttons. Access to the enhanced video management features (database search, event download, etc.).
<input type="radio"/>	<a href="#">Multi View</a>	user	Images or events of this and other MOBOTIX cameras arranged in different ways.
<input type="radio"/>	<a href="#">PDA</a>	guest	Live images for low resolution devices.
<input type="radio"/>	<a href="#">PDA Event List</a>	user	List of events in a compact layout.

Page Design

Background Image: Default background image Select the background image for the dialogs and the user interface. You can use custom images by uploading them to the camera in the [Manage Image Files](#) dialog.

Page Options

- **Guest:** The Guest screen of the camera (section 4.7, *The Guest Screen*) shows the live image of the MOBOTIX camera with the preset frame rate. A visitor on this screen may set the values up to the maximum frame rate that you allowed using the **Refresh Rate for Guest Access > Max.** parameter.
- **Live:** The Live screen of the camera (section 4.3, *The Live Screen in the Browser*) shows the live image of the MOBOTIX camera with the softbuttons on the left side. This screen allows using different softbutton functions and also provides the Quick Controls (pull-down boxes above the live image) for changing the selected image parameters.

Select the language  
MOBOTIX provides  
different language  
versions of the camera  
software

Set one of the available  
pages as entry page

- **Player:** The Playback screen of the camera (section 4.4, *The Playback Screen in the Browser*) allows searching and viewing the events recorded by the camera. This screen also provides access to the enhanced video management features (database search, event download, etc.).
- **MultiView:** The MultiView screen of the camera (section 4.5, *The MultiView Screen in the Browser*) allows viewing several MOBOTIX cameras (or several event images) on one screen in the browser.
- **PDA:** The PDA screen of the camera (section 4.6, *The PDA Screen*) shows the current live image. This screen has been designed specifically for low-resolution displays (e.g. PDAs and mobile phones).
- **PDA Event List:** The PDA Event List of the camera (section 4.6.2, *Controls and Event List*) gives a overview of all stored events in a concise list, which has been optimized for PDAs and mobile phones.

**You can also set the following start options:**

- **Background Image:** This parameter allows selecting a custom background image for the user interface of the camera in the browser. Make sure that you upload the corresponding graphics file (JPEG or PNG) into the camera (**Admin Menu > Manage Image Files**):

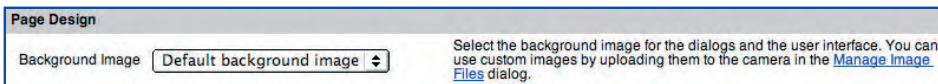

Define custom background image

- **Image Pull-Down Menus:** Enables/disables the Quick Controls of the Live screen.
- **Refresh Rate (Guest/User):** Allows setting the maximum and the default refresh (frame) rate for the Guest and the Live screens, respectively.

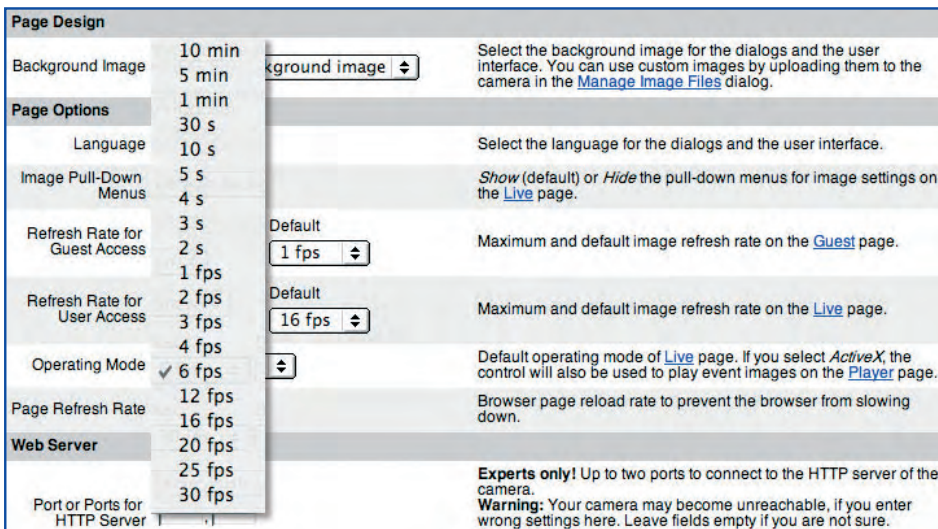

Set the Refresh Rates

- **Operating Mode:** Select the standard operating mode for the Live screen. If possible, set this option to *ActiveX*. The camera software automatically detects if the browser and the operating system support ActiveX and selects the best operating mode.

**Caution:** Improper use may render the camera inaccessible

- HTTP Port(s):** The default port for accessing your MOBOTIX camera in a browser is port **80**. You can set two different ports for accessing the camera using this parameter. If you configure port **8000**, for example, your camera can only be accessed using the IP address `http://10.1.0.99:8000`. Any modifications of the camera's HTTP port will only become effective after the camera has been rebooted. It is recommended to only change this setting with good reason. Take extra care to avoid ports that are already being used (such as port 21 for FTP), but use ports from 1025 upwards. For a list of well-known ports, see [www.iana.org](http://www.iana.org) (look for *port numbers*) or search the Internet for "well-known ports".

Two different ports for camera web server possible

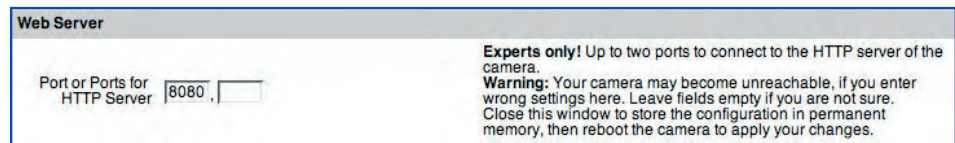

### 5.4.5 Microphone and Speaker



The camera also transmits the audio channel

You can display the sensitivity and the trigger value of the microphone in the live image (**Setup Menu > Text and Display Settings**)

Chart display:  
 - **Bars** (shown)  
 - **Scroll Chart**

The MOBOTIX camera has an audio channel with microphone and speaker. Among other things, the audio channel is used for the telephony functions. This means that the camera can establish a voice connection to an external phone (using ISDN or IP telephony connections) and it can receive voice calls from a phone (see also chapter 9, *Telephony Functions*).



In the **Admin Menu > Loudspeaker and Microphone** dialog, you can individually configure and test both the microphone and the speaker (**Test** button). Set the corresponding checkboxes to activate/deactivate the devices. These settings will affect all other camera settings that are using the audio functionality of the MOBOTIX camera.

You can set the microphone either to *Low*, *Medium* or to *High sensitivity*. The speaker volume can be controlled in a similar way. To play back sound over the camera speaker at a low volume, choose a value of *-18*, for normal indoor volume, choose *6*.

#### Note

The microphone can react to noise or sounds in the vicinity of the camera (provided the **Microphone (MI)** event has been activated in the **Event Settings**). You may set the trigger value that triggers an event, and also set the minimum duration the trigger level has to be surpassed before the camera triggers. See section 7.6.1, *Event Selection*, for more information on this topic.

**Hint:** Open **Setup Menu > Display and Text Settings**, set the **Level Meter** to *Bar*, select *Microphone* as **Level Meter Data**, then click on **Set**. The level meter that is now displayed in the live image of the camera helps to determine the best possible trigger level for your application.

This dialog also allows to **permanently and irreversibly deactivate the microphone** (**Admin Menu > Microphone and Loudspeaker > More**, then click on the **disabled** link and follow the instructions). You will find additional information in this and the following dialogs.

The possibility to permanently and irreversibly deactivate the microphone has been created for reasons of privacy protection and to comply with the regulations of specific countries. It is not allowed in some countries, for example, to install surveillance devices that can record or transmit sound (e.g. in Germany when monitoring workplaces).

**Warning:** Make sure you understand that this deactivation is permanent and cannot be reversed even by MOBOTIX engineers!

Set the microphone to be displayed on the level meter

The microphone can be deactivated irreversibly



## 5.5 Image Controls

### 5.5.1 Overview

In the dialogs of the **Setup Menu > Image Control** page, you can set all parameters related to images and exposure times. This includes color display, JPEG settings as well as text and display settings, i.e. the way text and status information is displayed within the camera image.

### 5.5.2 General Image Settings

In the **Setup Menu > General Image Settings** dialog you can set various parameters that determine how the live image is displayed. These settings include (among others) the image sensor to be displayed, the image resolution and the image sharpness. You can modify some of the aforementioned parameters directly using the Quick Controls (pull-down boxes above the live image) on the Live screen (see section 4.3, *The Live Screen in the Browser*).

Read carefully!

Night models automatically switch between day and night lenses (**Auto** setting)

Secure (M12, D12, V12, M22) models allow obscuring (masking) image areas

Camera Model	X	-
	X	-
	X	-
	-	X
	-	X

Camera Model	X	-
	X	-
	X	-
	-	X
	-	X

Sensor	Value	Explanation	
Camera Selection	Auto	<b>Camera Selection:</b> Factory default: <i>Auto</i>	
Camera Night Switch (DY/NI)	10 lux	<b>Night Camera Level:</b> If camera <i>Auto</i> is selected, the camera switches between day and night sensor if illumination crosses this level. Factory default: <i>10Lux</i>	
Attribute	Value	Explanation	
Image Size	VGA (640x480)	<b>Image Size:</b> Factory default: <i>640x480</i>	
Sharpness	Left	Right	Explanation
Sharpness	4	4	<b>Sharpness:</b> Factory default: <i>4</i>
Noise Suppress	Low	Low	<b>Noise Suppress:</b> Image noise reduction: <i>Off</i> : disable noise reduction <i>Low</i> : no sharpen and less color <i>Medium</i> : blur and no color <i>High</i> : blur, no color and output black image Factory default: <i>Low</i>
Security Options	Explanation		
Obscure Image Area (OA)	Enable	<b>Obscure Image Enable:</b> This parameter allows you to cover parts of the image.	
	Weekdays_Mo-Fr	<b>Obscure Image Time Table:</b> Time table profile for time-controlled obscuring. ( <a href="#">Time Tables</a> )	
	0, 540, 380, 200, 200, 2	<b>Obscure Image Area:</b> lens, x, y, width, height, type Origin: lower left corner Lens: 0=right, 1=left Type: 0=filled box, 1=crossed frame, 2=mosaic (default)	
		<b>Add Rectangle</b>	

- Camera Selection:** Select the left or right sensor to be used for the live image if your camera is a dual-lens model. The *Both* option creates a side-by-side image of both sensors. *RiL* displays a miniature version of the right sensor within the image of the left sensor. *LiR* displays a miniature version of the left sensor within the image of the right sensor.

Activating the *Auto* setting in a **MOBOTIX Night model** causes the camera to automatically switch from the right to the left sensor when the illumination falls below the value set for **Camera Night Switch (DY/NI)**. Once the defined threshold value is exceeded again, the system switches back to the right daylight sensor (see section 5.8, *Day & Night Modes*).

In a **MOBOTIX Dual model**, combining the *Auto* option with a **Time-table Profile** (see section 7.8.6, *Time Tables*) will let the camera switch sensors in a scheduled manner. When the Time Table profile is active, the camera uses the right sensor; otherwise, the left sensor will be used.

- Display Mode:** This option is preset to *Full Image*; selecting the *EiP* option (Event in Picture) will show the last event as a small image in the bottom right corner of the live image. The *PiZ* (Picture in Zoom) option will show the full image as a small image in the bottom right corner of the zoomed image (2x, 4x).
- Resolution:** This sets the image size that is displayed by the camera. You can choose from the following resolutions: *MEGA (1280x960)*, *VGA (640x480)*, *CIF (320x240)*, *PDA (160x120)*, *D-1 PAL (768x576)* and *Custom Size*.

**Custom Size:** The *Custom Size* option allows defining a camera image of almost any size. You can either define the image size using the mouse or by manually entering the desired values in the text field. The camera software always rounds the pixel values to the next lower multiple of 16.

**To define a custom image size, proceed as follows:**

- Define the first corner point of the image window by Shift-clicking with your mouse in the live image.
- Define the second corner point of the image window diagonally across by clicking with your mouse in the live image (left-click).
- You have drawn a yellow frame that represents the user-defined image window. Click on **Set Rectangle Size** in the dialog to enter the coordinates of the new image window in the **Custom Size** field. Clicking on the **Set** button will display only the custom size image on the camera's Live screen.



Image sensor selection:

- Right
- Left
- Both
- RiL
- LiR
- Auto

Kamerasmodell	
X	-
X	-
-	X
-	X

Kamerasmodell	
X	-
X	-
-	X
-	X

Display Mode:

- Full Image
- EiP (Event in Picture)
- PiZ (Picture in Zoom)

Kamerasmodell	
X	-
X	-
-	X
-	X

Kamerasmodell	
X	-
X	-
-	X
-	X

Custom image size (SKYLINE)

Kameramodell	X	-
X	-	-
X	-	-
-	X	-
-	-	X

1x, 2x, 4x digital zoom  
with panning

Maximum frame rate

Set the maximum frame  
rate not higher than  
actually necessary

- **Operating Mode:** This parameter controls how the MOBOTIX camera generates and displays the live images. Selecting the *Quality* option (factory default) will always read the full area of the image sensor. This will deliver the best image quality. Selecting the *Frame rate* option will always deliver the highest frame rate of the camera. As this reduces the bandwidth, image quality is somewhat reduced.

- **Digital Zoom:** The **1x Zoom**, **2x Zoom** and **4x Zoom** buttons of the Live screen provide for zooming into or out of the image with 2x and 4x enlargement; **1x Zoom** displays the unzoomed view.

The *Lock Zoom* option sets the current zoom factor and disables the functions of the zoom softbuttons. Setting the *Unlock Zoom* (default) option allows to freely set the zoom factor using the softbuttons.

The *Lock Pan* option sets the position of the zoomed camera image without allowing any changes. Setting the *Unlock Pan* option (default) allows moving the image pan by clicking in the live image (for more information on panning, see section 4.3.2, *Setting Image Formats*).

Using the **Define Rectangle Position** button (with selected *Lock Pan* option), you can set a rectangle within the live image to be used as zoom position. The rectangle is defined in the same manner as described above for **Resolution > Custom Size**.



- **Frames per Second / Maximum Frame Rate:** Defines how many live images per second the MOBOTIX camera creates (in frames per second, or fps). Note that the frame rate displayed in the browser and in the MxViewer cannot be higher than the value set here.

Using this setting, you can actively reduce the camera's processing time and thus free capacity for other tasks (e.g. if several users must be able to access the camera at the same time over the Internet). It is recommended that you set the maximum frame rate not any higher than actually required. Thus, a frame rate of 1 frame/second would be more than sufficient for a camera used as web cam.

- **Mirror & Rotate Image:** These settings enable you to mirror the camera image either horizontally or vertically and to rotate it 180 degrees. This can make sense if the camera has been mounted to the ceiling upside-down or uses mirrors in connection with presentation systems (mirrored image).

**Caution:** Note that this setting may reduce the maximum frame rate.



- Sharpness:** Use this parameter to sharpen the camera images using the camera software. Note: Using a value that is too high may result in poorer image quality (e.g. for high-contrast situations or for images with many fine details). This is particularly true for low quality JPEG images or for an enlarged image display on the screen, e.g. when used with MxViewer.
- Dark Noise Suppress:** In poor lighting conditions, background noise can result in poor image quality (see section 5.8.2). The Dark Noise Suppress parameter minimizes this effect:
  - Off:* Deactivates the dark noise suppression feature.
  - Low:* Reduces sharpness, displays less color (default).
  - Medium:* Creates blur, displays no colors (greyscale image).
  - High:* Creates blur, displays a black image.
- Obscure Image Area (OA):** Using this feature, you can cover certain areas in the live image of the camera. This may be necessary to protect employees' privacy, for example, as is the case when monitoring workplaces in certain situations (e.g. a bank teller). Provided that the respective image areas have been obscured, you can still use your MOBOTIX camera. When combined with a time-table profile, such areas can also be obscured according to a weekly schedule that corresponds to the office hours. For additional information on this topic, see section 7.8.6, *Time Tables*.

You may set different image areas to obscure the right and the left image sensor. Several areas can be defined per sensor.

The last parameter controls the type of cover:

- 0: Filled box
- 1: Crossed frame
- 2: Mosaic

Using the **Define Rectangle Position** button, you can draw a rectangle within the live image to be used for the obscured area. The rectangle is defined in the same manner as described above for **Resolution > Custom Size**.

Resolution	Model
X	-
X	-
-	X
-	X

**Secure (M12, D12, V12, M22)** models allow obscuring (masking) image areas:

- Mosaic
- Area
- Frame

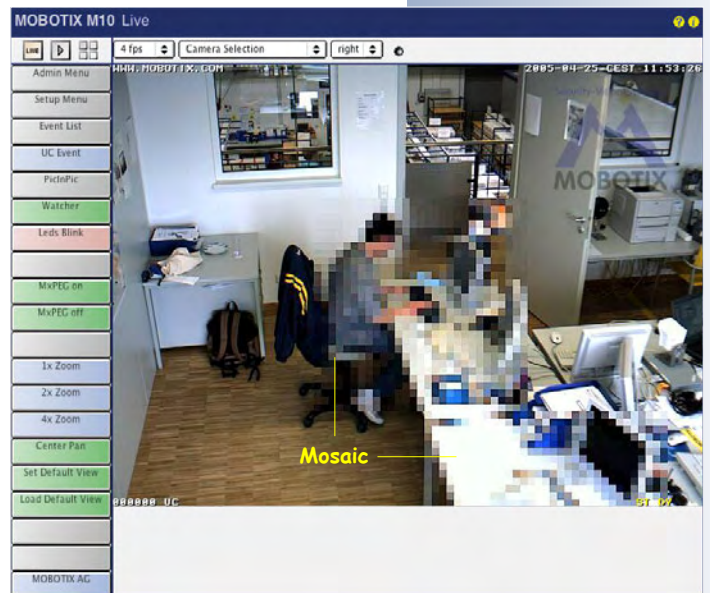



Display text and status information directly in the live image

### 5.5.3 Text Settings

Your MOBOTIX camera allows you to display a lot of **text and status information** directly in the camera image. In the **Setup Menu > Text and Display Settings** dialog, you can set date and time, text, comments, error messages and event, action, message and recording type symbols that are displayed directly in the camera image as text. In addition, you can use the **level meter** to visualize the values obtained from specific sensors or events. This greatly facilitates setting certain parameters (e.g. the sensitivity of the PIR sensor). Another feature activated here is the visual display of moving objects (**Object Tracing**).

Displayed text can consist of static image text, web addresses, current camera status information as well as **dynamic sensor data** and **data of other devices connected to the serial interface**. On top, you can set the background and text colors and you can set the transparency of the background color. For additional information on this topic, read section 5.5.4, *Placeholders and Variables in the Comment Field* and the corresponding topics of the camera help and the reference manual (look for *placeholders* and *variables*).

Attribute	Value	Explanation
Text Display	On	<b>Text Display:</b> The <i>Date &amp; Time</i> option will only display date and time.
	White	<b>Text Color:</b> Select the default text color.
	Black	<b>Background Color:</b> Choose your own background color.
	Transparent	<b>Background Opacity:</b> Opacity of text background.
	Date & time	<b>Date and Time:</b> Select format of date and time
	WWW.MOBOTIX.COM Factory Ip address: ~N Framerate (FPS): ^h	<b>Comment:</b> This text will be displayed on every image. This parameter allows using <a href="#">comment variables</a> and standard <a href="#">variables</a> .
On	<b>Error Messages:</b> Enable error messages in image	
On	<b>Cover Borders:</b> Covers the borders of inset or dual images with bars.	
Display Options	Symbols	<b>Show Event/Action Symbols:</b> Show event symbols. Use <i>Symbols</i> if many events are activated.
	Off	<b>Level Meter:</b> Display level meter as bar graph or scroll chart. Level meter is displayed in the lower left corner.
Object Tracing (OT)	Disable	<b>Enable Object Tracing:</b> Trace objects moving within the image area.

Buttons: Set, Factory, Restore, Close, Less

The Comment field may also contain placeholders and variables

- **Text Display:** This parameter enables or disables all displayed texts in the camera live image. The *Date & Time* option displays only the date and time information in the upper right area of the live image. If this setting is activated, neither the text entered in the **Comment** field (see below) nor the event and action symbols in the lower area of the live image will be shown.
  - **Text Color:** This parameter controls the text color; select a color from the palette of predefined colors.
  - **Background Color:** This parameter controls the text background; select a color from the palette of predefined colors.
  - **Background Opacity:** This parameter sets the text background opacity. The *Transparent* setting displays the text without background color while the *Full BgColor* setting covers the image background completely. Intermediate settings are 25%, 50% and 75%.
  - **Date and Time:** Use this parameter to configure the date and time format. Several formats are available.
  - **Comment:** The text entered in this text field will be displayed in the upper left area of the live image. Using placeholders and variables, you can display dynamic texts and camera status information. For additional information on this topic, see section 5.5.4, *Placeholders and Variables in the Comment Field*.
- Note:** To position the text, you can also use the `^gx, y;` placeholder.
- **Error Messages:** The *On* option displays camera error messages in the lower image area. Such an error message, for example, can report an unsuccessful FTP data transfer, an unsuccessful telephone call or a file server used as external image storage that cannot be reached.
  - **Cover Borders:** The *Top/Left* option covers the borders of dual images and of picture-in-picture displays with narrow bars in the defined background color.
  - **Show Event/Action Symbols:** The *Symbols* (one-line display) and *Symbols II* (two-line display) options display abbreviations for events, actions, messages and recording modes at the bottom of the live image. This is the main source of information regarding event control and recording activities of your MOBOTIX camera.
  - **Level Meter, Level Meter Data:** The level meter can display the values measured by different camera sensors (PIR sensor, microphone, illumination value, signal input, event counter, temperature) as a *Bar* with trigger value (vertical white line) or as time-related *Scroll Chart* in the lower area of the live image. This helps monitoring the defined trigger values and when fine-tuning is required.

Display texts, variables, comments as well as date and time information directly in the live image



- **Object Tracing (OT):** This parameter will identify up to five moving objects and to highlight the movement by displaying the object traces in different colors.

Kameramodel	X	-
X	-	
X	-	
-	X	
-	X	

The MOBOTIX camera can trace a **maximum of five objects** simultaneously

Different objects are displayed in different colors

Placeholders and variables insert dynamic texts (refer to the camera help and the reference manual for more information on this topic)

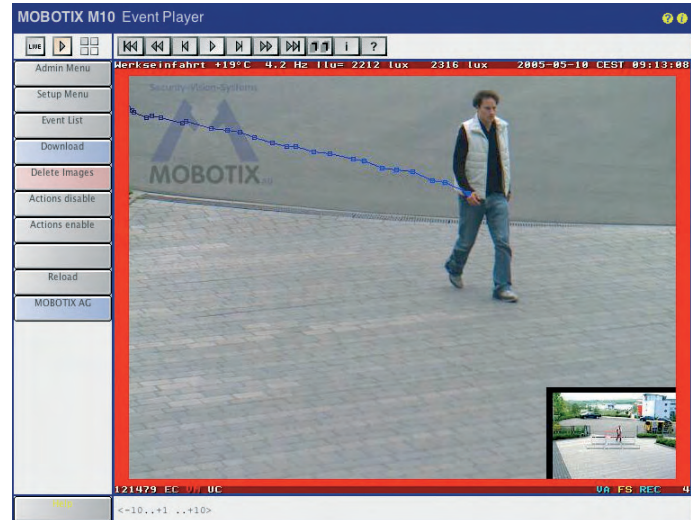

#### 5.5.4 Placeholders and Variables in the Comment Field

For detailed information on the placeholders and text variables in the comment field that are available for your camera model and software version, see the camera help (keywords: *placeholder*, *variables*) as well as the reference manual. The following list contains a small **selection**:

- **~E:** The current IP address of the camera's Ethernet interface
- **~H:** Current host name of the camera
- **~N:** The camera's factory default IP address
- **^IR:** Illumination value of the right camera lens
- **^IL:** Illumination value of the left camera lens
- **^Ti:** Internal camera temperature in degrees Centigrade
- **^Ld:** Date and time of the last image recording
- **^Ls:** Time since last image recording in seconds
- **^s#:** Display of RS232 data (# specifies the number of lines)
- **^#nn:** Display of colored text with values for **nn** ranging from **00** (black) to **0F** (white)
- **\$(ID.SWV):** Software version of the camera
- **\$(SEN.TIN.FAHRENHEIT):** Internal camera temperature in degrees Fahrenheit
- **^gx,y;:** Free positioning of text using the parameters **x** and **y** (units are character width and character height as displayed in the image; the zero position is in the top left corner of the image).



5.5.5 Examples for Placeholders and Variables in the Comment Field

The following example creates text in the upper left corner of the image (camera model, software version). The software version is displayed using the \$(ID.SWV) variable.

**Camera Model: M12D-Night-D43N43**  
**Software Version: \$(ID.SWV)**

The following example displays a yellow (^#0B) text ("Please lock ...") at a distance of 25 characters from the left edge of the image and 20 characters from the upper edge of the image.

**^#0B^g25,20;Please lock door after 6:00pm !!**

The example below displays a white (^#0F) text ("WWW.MOBOTIX.COM") at a distance of one character from the right edge of the image (first parameter -1). An automatic line break occurs (after one character in this case). The text is displayed at a distance of 16 characters from the bottom edge of the image (second parameter -16).

**^#0F^g-1,-16;WWW.MOBOTIX.COM**

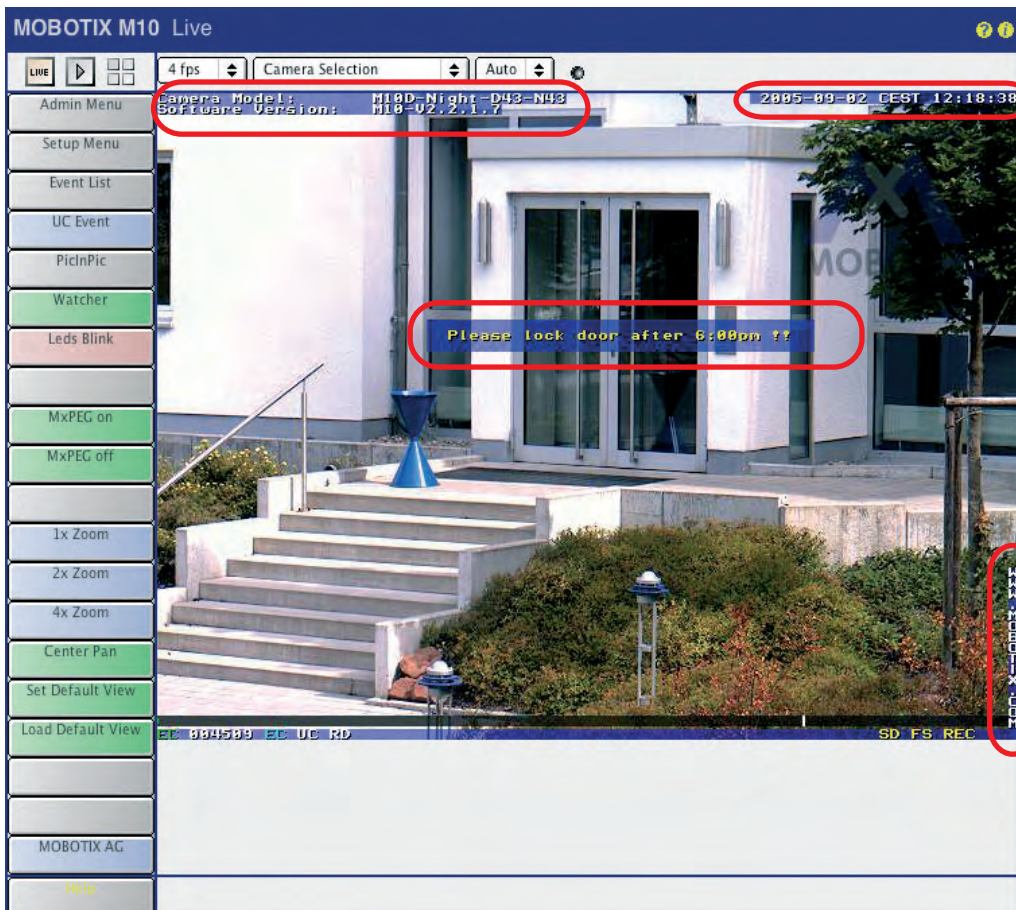

Text display in the live image

The following example displays text received as network message (see section 7.6.1, Event Selection) at the beginning of line 5; max. length is ten lines:

**^g0,5;^s10**

Displays text in network messages (IP Receive) in the live image



### 5.5.6 Compression Format and Image Quality

Open **Setup Menu > JPEG Settings** to set the image format created internally by your MOBOTIX camera (JPEG or MxPEG) and set the quality of the image data.

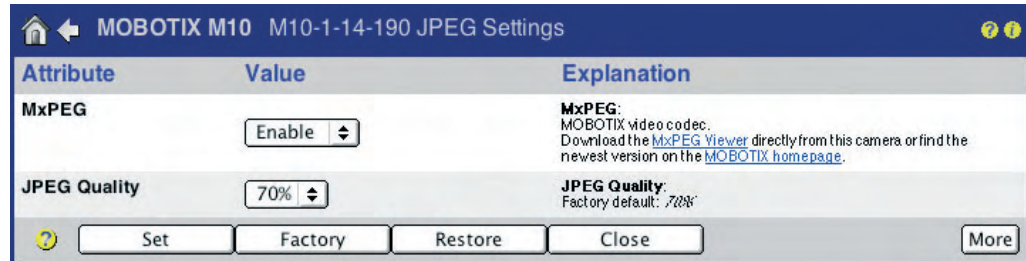

#### JPEG:

For web applications

#### MxPEG:

For fast live video with audio

If the camera would output an uncompressed color image with 640 x 480 pixels (e.g. as a bitmap image), the file created (and thus each individual live image) would be about 1 MB in size. Transferring this file to the user's computer using an ISDN connection would take about 2 minutes or using a 10 Mbps Ethernet connection still 1 second. It is easy to see why this format is not suitable for transferring and storing image data at high frame rates.

When selecting **JPEG (MxPEG: Disable)**, the individual images are compressed to a size of 60 to 70 kB (**JPEG quality: 70%**). Moreover, JPEG live images can be displayed immediately in all graphical browsers without having to install additional plug-ins.

When selecting **MxPEG (MxPEG: Enable)**, the video stream is reduced further (requires MxPEG **ActiveX** and the Windows Internet Explorer to be installed; needs ActiveX operating mode for the browser). No matter which type of recording you have selected, this operating mode allows for considerably higher frame rates and for transferring the realtime camera sound. For additional information on the operating modes, see section 4.3.3, *Browser Settings, Operating Mode* and section 4.10, *Fast Video Streaming*.



**Note**

Regardless of the chosen format, the live image is displayed in every web browser. If a browser does not support MxPEG (or if ActiveX has not been installed), the camera automatically switches to JPEG. Moreover, the camera can continue storing images in JPEG format (e.g. on a web server using FTP) even though it is running in MxPEG mode.

The size of the image files created by the camera depends on the degree of compression, among other things. Compression can be defined as a percentage value set by the **JPEG Quality** parameter. Using a compression of 60% will usually deliver good-quality images for most purposes. If the value is lower than 20%, you can see tiles within the image. For a value higher than 70%, differences to the uncompressed original image are hardly visible. The file size, however, may increase to more than 100 kB for a 640x480 (VGA) image.

The example image (in 80% and 20% compression) and the table will give you an idea of the approximate file sizes and the corresponding image quality. Note that the file size also depends on the scene itself and that it increases with the number of details displayed in the image. Thus, the table shown only contains approximate file size values.

<b>JPEG-Quality</b>	<b>160x120 PDA</b>	<b>320x240 CIF</b>	<b>640x480 VGA</b>	<b>1280x960 MEGA</b>
<b>20% (low)</b>	<b>5 kB</b>	<b>10 kB</b>	<b>20 kB</b>	<b>56 kB</b>
<b>40% (medium)</b>	<b>6 kB</b>	<b>15 kB</b>	<b>31 kB</b>	<b>90 kB</b>
<b>60% (high)</b>	<b>8 kB</b>	<b>19 kB</b>	<b>41 kB</b>	<b>136 kB</b>
<b>80% (highest)</b>	<b>10 kB</b>	<b>30 kB</b>	<b>64 kB</b>	<b>213 kB</b>

Average image sizes of  
JPEG images

**Note**

**The MxPEG setting reduces the speed of the exposure control. We therefore recommend the JPEG setting for all applications that are not dependent on high frame rates.**

### 5.5.7 Color Settings (Color Profile and Saturation)

Open **Setup Menu > Color Settings** to adapt the color display of your MOBOTIX camera to certain sources of light.

Depending on the source of light (sun, incandescent bulb, fluorescent light, etc.), the portion of light reflected by a white wall contains different colors. The human brain corrects this colored non-white light (the tint) automatically. The MOBOTIX camera software automatically corrects the color display using its **white balance** feature and, thus, displays the wall as being **objectively white** in the camera image.

#### Note

**Changing the color settings is usually not feasible**, as the factory settings and the automatic functions of the camera will produce high-quality images most of the time. If the lighting conditions are difficult, we recommend to select one of the preset color profiles or to cautiously change the values of the blue and the red balance.

Caution when changing the color saturation

MOBOTIX cameras feature predefined color profiles

Attribute	Left	Right	Explanation
White Balance	Automatic WB	<input checked="" type="checkbox"/> Automatic WB <input type="checkbox"/> Cloudy/Hazy <input type="checkbox"/> Outdoor <input type="checkbox"/> Sunny <input type="checkbox"/> Fluorescent Lamp <input type="checkbox"/> Incandescent Lamp <input type="checkbox"/> Gray World	<b>Color Profile:</b> Select color profile for white balance regulation. Factory default: <i>Automatic WB</i>
Color Saturation	0		<b>Color Saturation:</b> Increase or decrease color saturation. Factory default: <i>?</i>
Blue Balance	0		<b>Blue Balance:</b> Amplifies the blue channel. Factory default: <i>?</i>
Red Balance	0		<b>Red Balance:</b> Amplifies the red channel. Factory default: <i>?</i>

**Current Device Settings**  
 White balance range R=0% L=0% · Hardware gain range R=0% L=100%  
 Right GRB=2048 3200 3072 / Current=2048 3200 3072  
 Left GRB=1024 1024 1024 / Current=1700 2500 3000

Set Factory Restore Close Less

**Color Profile:** Pre-defined color profiles are available for specific light situations and can be set differently for each image sensor:

- **Automatic WB (White Balance):**

The factory default setting should produce the best results for most lighting situations.

- **Cloudy/Hazy:**

If the *Auto* setting does not deliver satisfactory results in cloudy conditions, try using this profile for white balance.

- **Outdoor:**

You can use the *Outdoor* color profile as an alternative to the *Cloudy* and *Sunny* profiles. This profile is best suited for changing outdoor illumination (sun, clouds, etc.).

- **Sunny:**

This setting improves the image colors with mostly clear skies and a lot of sunshine. Use this color profile to automatically set the white balance.

- **Fluorescent Lamp:**

This setting improves the image colors if fluorescent lamps are the primary source of light. Use this color profile to automatically set the white balance.

- **Incandescent Lamp:**

This setting improves the image colors if incandescent lamps are the primary source of light. Use this color profile to automatically set the white balance.

- **Gray World:**

In backlight situations, the camera image may display colored fringes where image areas are too bright. This color profile will reduce or even prevent this effect from showing. Compare the results of using this color profile to the *Automatic WB* profile, especially if you are using the camera as a webcam for country scenery, for example.

**Color Saturation:** Use this parameter to increase/decrease the color saturation of the image. A value of "-10" creates an image without color, i.e. a monochrome B/W image. The higher the defined value, the more color is displayed in the image.

**Blue Balance, Red Balance:** On top of automatic color correction, you can adjust the blue/red balance when required (the green portion cannot be changed).

#### Note

**White balance is difficult** for sources of light with a spectrum that is not continuous, such as sodium vapour lamps, for example. This is not a limitation of the MOBOTIX camera. Obtaining proper values for white balance is not possible in this case due to the laws of physics.

Different color profiles  
for different illumination





## 5.6 Logos

### 5.6.1 Overview

The logo generator of your MOBOTIX camera can display one or several logos (graphic files) with free contours and selectable transparency in the camera image and features pixel-precise positioning and automatic alignment at any image border with definable offsets.



When displaying logos, the MOBOTIX camera can switch automatically between several logos with different sizes that have been assigned to different resolutions. Note that the logos can also be displayed permanently or controlled by a schedule (**Admin Menu > Time Tables**). Another possibility is to rotate several logos at a set interval, which also allows creating simple animations in the live image.

### 5.6.2 Managing Image Files

Prior to displaying any logos you need to upload the corresponding graphics files (PNG or BMP) into the camera (**Admin Menu > Manage Image Files**). You can either upload the files manually (provided you are a user with Admin rights) or the camera can download the respective files automatically from the previously configured URLs on a web or FTP server, updating the files at a predefined interval. In order to access protected areas on an FTP server, you can set a user name and password for each of these entries.

#### Note

**One single image file may not be larger than 228 kB, a TAR archive file may not be larger than 246 kB.** It is recommended to use PNG files since they are a lot smaller than bitmap (BMP) files. In addition, PNG files allow saving a transparent background (set this color when saving the file).

- **Image File:** Click on the **Browse** button to select a graphics file (or the TAR archive stored from another MOBOTIX camera). Then, click on the **Upload** button to upload the file to the camera. The **Keep** option makes sure that a number is added to the name of a newly uploaded graphics file in case the names happen to be identical, allowing you to keep the old file. If the **Overwrite** option is activated, newly uploaded files with the same name automatically overwrite files already in the camera.

Use PNG or BMP files

Uploading graphics files to the camera

**MOBOTIX M10 M10-1-14-190 Manage Image Files**

**Upload Image File**

Image File:

Select an appropriate file on your local computer. Currently, archive files (suffix *.tar*), Portable Network Graphics files (suffix *.png*) and Windows bitmap files (suffix *.bmp*) are supported. A single image file may not be larger than 174 KBytes. The archive file must not be larger than 246 KBytes, otherwise it can not be processed.

Existing Image Files:

Choose **Overwrite** if you want to overwrite already existing images. Choose **Keep** to have the uploaded image file renamed automatically if its name is already used.

**View System Images**

**Stored User Images**

Name	Size	Format	Transparency	Select Image
<a href="#">ballon_logo_2</a>	34 KBytes	PNG (640 x 480 x 24)	alpha	<input type="checkbox"/>
<a href="#">mobotix_logo_lowres</a>	49 kByte	Bitmap (150 x 112 x 24)	alpha	<input type="checkbox"/>
Total:		69 KBytes	Free: 174 KBytes	<input type="button" value="Remove"/>

**Download Image Files**

Select:  [ballon\\_logo\\_2](#)  [mobotix\\_logo](#)

Select one or more image files you would like to download to your local computer. Use [Ctrl]-click to select multiple files. Image files are stored as an archive file. This file can be uploaded to other cameras. Use WinZip, Stuffit or Powerarchiver to view the contents of the archive file.

**Images Loaded From URL**

Name	URL	Reload page	Username	Password	Options
<input type="text" value="mx_logo"/>	<input type="text" value="http://www.mobotix.de/mx_logo.png"/>	<input type="button" value="1 h"/>	<input type="text" value="mxuser"/>	<input type="text" value="mxpass"/>	<input type="checkbox"/> Inactive <input type="checkbox"/> Delete

1. Search graphics file on your computer

2. Upload graphics file to the camera

You may load more than one file into the camera

Loading logo files from a URL

- **Stored User Images:** This list contains the graphics files you have already uploaded to the camera. The image and file sizes are displayed in the **Size** columns. The **Format** column contains additional information on the file type, image size and color depth of the image. The area below this table displays how much storage capacity the graphics files are using (**Total**) as well as the free storage space (**Free**).
- **Download Image Files:** This option allows downloading the graphics files from the camera and storing them on a local computer. In this process, all selected files are combined in a TAR archive (image\_archive.tar). This TAR archive can then be uploaded to other MOBOTIX cameras. This section is available only if you already have stored graphics files in your camera.
- **Images Loaded From URL:** This section of the dialog allows specifying graphics files that the MOBOTIX camera will download automatically from a web or FTP server. Specify the file's location on the server in the **URL** field. Enter a descriptive name in the **Name** field for easy identification later on. Once the graphics file has been uploaded to the camera, it is available in the logo profiles under the name you just entered.

The graphics file is uploaded when you click on the **Set** button, after the camera has been rebooting and automatically when the interval defined in the **Reload page** field has expired (any time span between 5 minutes and 24 hours). This allows replacing a graphics file on the web server and to have the camera (or even several cameras at the same time) automatically update the graphics file. If you fill in the **User Name** and **Password** fields, the camera can also load files from protected web or FTP server areas.

Click on the **Set** button to save the settings, and the graphics file is downloaded from the server and the camera automatically creates a new empty line for additional graphics files.

The **Inactive** option prevents the automatic reload of the respective graphics file without having to delete the entire line. In order to delete the URL, activate the **Delete** checkbox and then click on the **Set** button.

#### Note

You can download the graphics files stored on the MOBOTIX camera to your local computer and then transfer these files to other MOBOTIX cameras.

### 5.6.3 Logo Profiles

The **Admin Menu > Logo Profiles** dialog provides all means for creating and configuring logo profiles. In order to use a graphics file in a logo profile, it must be stored in the camera or the camera must be able to successfully download it from a web or FTP server.

Every logo profile can be activated (*Display* option) or deactivated and it can be controlled using a time table (**Admin Menu > Time Tables**). All graphics files of all currently active logo profiles are displayed in the camera image and in the stored image, provided that the resolution of the live image corresponds to one of the resolutions highlighted in the logo profile. This also means that the camera can show more than one logo from different profiles at the same time.

- **Logo Display:** This is the main switch for all logo profiles. Using the *Enable* and *Disable* options, you can turn the display of logos in the camera image on or off, respectively.

#### Profiles & Options:

- **Profile Name:** Enter a unique and descriptive name for a logo profile.

Activated logo display

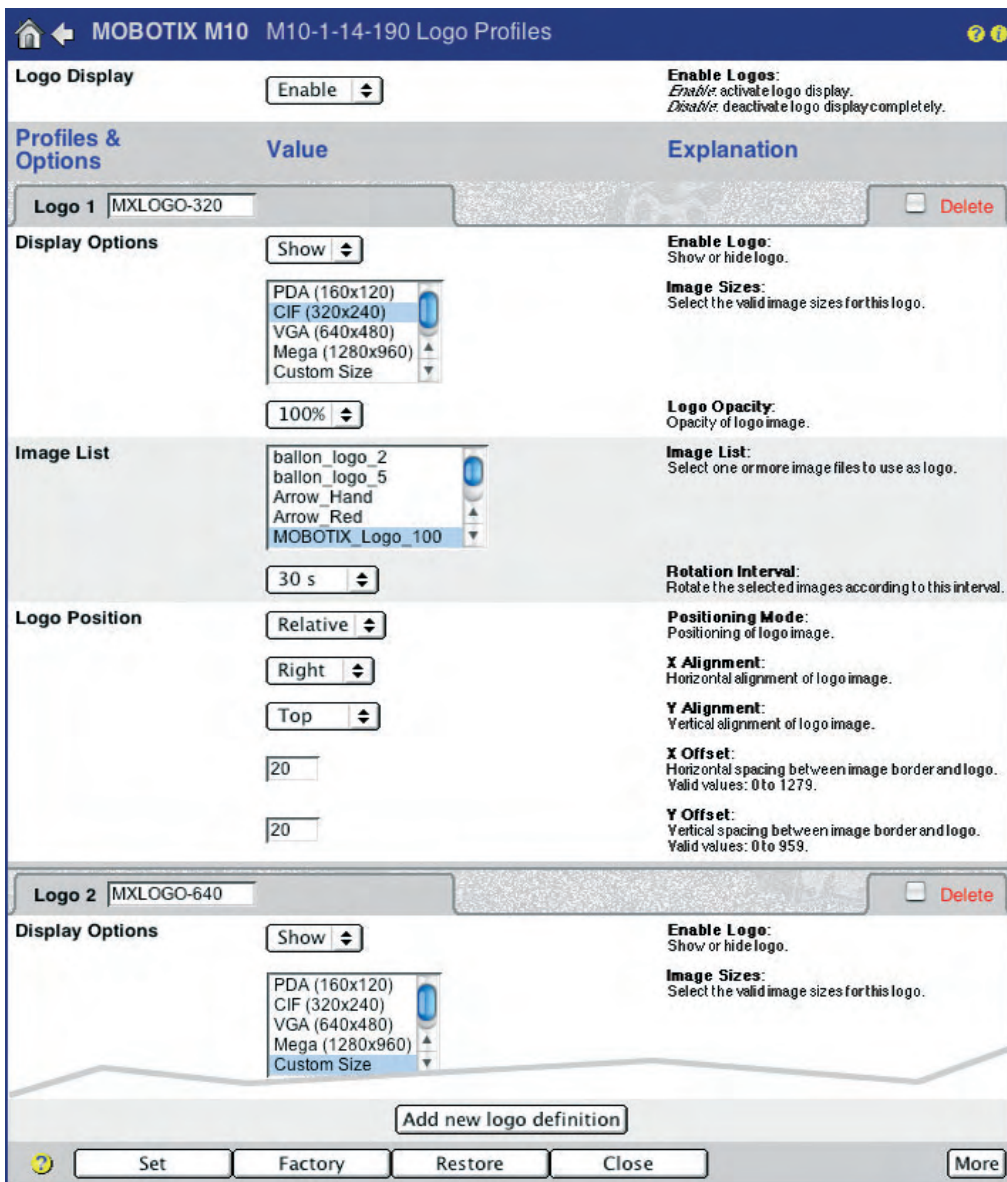

You may define **several logo profiles** with different parameters

### Display Options:

- **Enable Logo:** This option allows activating (*Show* option) or deactivating (*Hide* option) the individual logo profile. Only the logos of profiles set to *Show* will be displayed in the camera image.
- **Time Table Profile:** Select a previously defined time table to control the logo profile (provided that **Enable Logo** has been set to *Show*). In this case, the logo profile is active only at the times and on the days defined in the time table.
- **Live Image Logo:** This parameter controls whether the logo will appear in the *live image* (*Enable* option) or not (*Disable* option). A logo that you have disabled for a live image can still be shown on an image saved to an external file or web (FTP) server.

Controlling logos using time tables



Logos for different image sizes (resolutions)

Logo opacity (100% ... 10%)

Transparent logos, animated logos

Logos can be freely positioned within the image

- **Image Sizes:** Select the image sizes (resolutions) on which the selected logo(s) are to be displayed. The MOBOTIX camera can thus display graphics optimized for the selected image sizes. The following image sizes are available: PDA (160x120), CIF (320x240), VGA (640x480), MEGA (1280x960), D-1 PAL (768x576), Custom Size.
- **Logo Opacity:** Besides using the transparent color of a PNG file for transparent areas, you can also set the opacity of the entire logo. When choosing the 100% setting, parts of the camera image are hidden behind the non-transparent portions of the logo. For all other logo opacity settings, the camera image is shining "through the logo" at a certain percentage, giving a "watermark" effect.



- **Image List / Rotation Interval:** Select one or more logos/graphics files for display. If you have selected more than one logo, the selected logos are displayed one after the other, i.e. rotated at the defined interval (1 s ... 30 min). This feature also allows creating simple animations.
- **Logo Position:** Use this option to set the position of the logo within the camera image (*Relative* positioning mode) or to use a graphics file for creating an image frame (*Frame* positioning mode).
- **Positioning Mode Relative:** Use the **X Alignment** and **Y Alignment** parameters (*Left, Right, Top, Bottom, Center* options) to select how the logo will be displayed in horizontal (X) and vertical direction (Y). The **X Offset** and **Y Offset** parameters set the distance from the selected border. When using the X/Y Alignment *Center* option, the offset parameters are ignored.

- **Positioning Mode Frame:** Use the **X Frame** and **Y Frame** parameters to set a horizontal and a vertical width for the image frame to be created. The selected graphics file is then used to tile the area within the defined frame borders.

**Note**

**A logo is displayed in the live image, if these prerequisites have been met:**

- Logo Display has been *enabled*
- The logo profile has been activated: *Show* option
- A time table profile is currently active, if a time table profile has been set
- Live Image Logo has been activated: *Enable* option
- The resolution of the camera image has been set as valid resolution in the corresponding logo profile



Check list  
Logo display

www.naturbad-biebertal.de © Stadt Menden (Sauerland) 2005-06-16 BEST 10:42:04



Generate income using logos for advertisement purposes!

Setup Menu >  
Exposure Settings

## 5.7 Exposure Settings

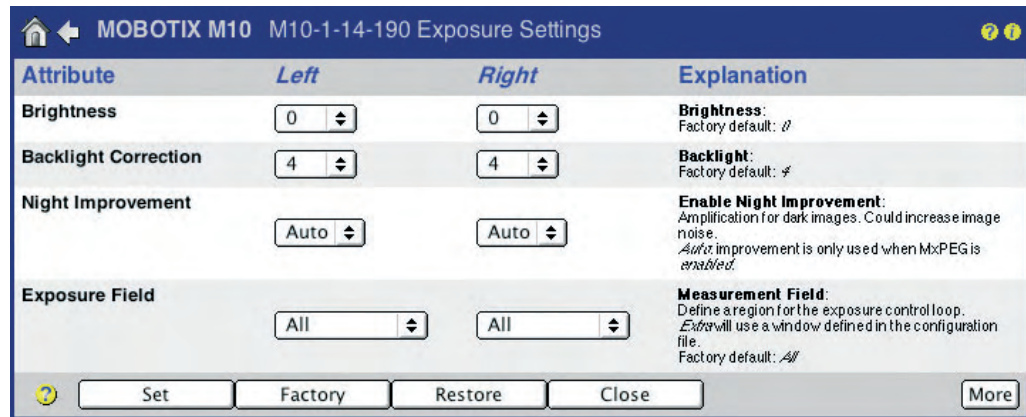

### 5.7.1 Overview

From the beginning, the MOBOTIX camera had been designed to transfer images to the Internet. Therefore, all MOBOTIX cameras are equipped with several **automatic features** that are allowing the camera to create the best possible images under all weather and lighting conditions. Hardly any manual modifications of the exposure settings are necessary; if they are required, they only make sense for very special lighting conditions.

The most important exposure control features are the camera's **Exposure Windows** (see section 5.7.6, *Exposure Windows*) and the **Maximum Exposure Time** setting, with both features providing the means to create crisp images (see section 5.7.5, *Exposure Setting Options*).

Furthermore, the MOBOTIX **Night** camera models are equipped with an automatic day/night switch that activates the eight times more light-sensitive B/W image sensor when illumination falls below the specified level (see section 5.8, *Day & Night Modes*).

### 5.7.2 Automatic Exposure

In order to obtain good quality images for all weather, contrast and lighting conditions, the MOBOTIX camera optimizes the raw images obtained from the image sensor(s). **Every** image is subjected to all automatic functions in the camera software, i.e. every image always has optimum quality.

The following **automatic functions** are part of the process:

- **Exposure time:** The camera automatically selects the best exposure time (between 1/8000 s and 1 s). This is done electronically and does not require any mechanical components (e.g. an auto iris).
- **Pre-amplification:** The camera automatically controls the pre-amplification level in the digital image sensor depending on the current lighting conditions and the current exposure time.

Always start from the **factory settings** when fine-tuning the image settings. As a first step, you should only set the predefined **exposure windows**. This approach usually delivers the best results.



- **White balance:** White balance is evaluated for **every image** and may even be restricted to specific reference areas within the image. This results in the MOBOTIX camera's true and brilliant colors.
- **Auto contrast:** Unfavorable weather conditions (rain, fog, etc.) reduce image contrast, but as the contrast is amplified automatically, the camera always uses the complete brightness range (from 0 to 100%).
- **Sharpness:** The high image quality of MOBOTIX cameras can also be attributed to the integrated, software-based sharpness filter. It almost fully compensates reduced image contrast due to dirty lenses and optical phenomena attributed to aging lenses.
- **Night Improvement:** This feature amplifies images taken with very little light.

Activated night improvement may increase dark noise

As the MOBOTIX cameras are **backlight-proof, no auto iris** is required in the lens. This allows installing an inexpensive and maintenance-free lens with fixed aperture in the camera. As this eliminates the need for moving parts, there is nothing that could freeze-lock in low temperature conditions (Antarctica, mountains, cooling facilities). It also means that the dark image parts of backlight situations can be better enhanced since there is no auto iris that reduces the amount of light on the image sensor.



### 5.7.3 Backlight Correction

Although equipped with automatic exposure control, most regular video cameras have huge problems handling **backlight** situations. The camera software needs to decide which image areas are to be properly exposed in a backlight situation, i.e. proper exposure of the dark image parts will lead to overexposure of the bright parts, proper exposure of the bright image parts will lead to underexposure of the dark parts.

MOBOTIX cameras, on the other hand, solve this problem by using exposure windows. The automatic exposure control features use these windows for measuring exposure, rather than the entire image area (see also section 5.7.6, *Exposure Windows*).

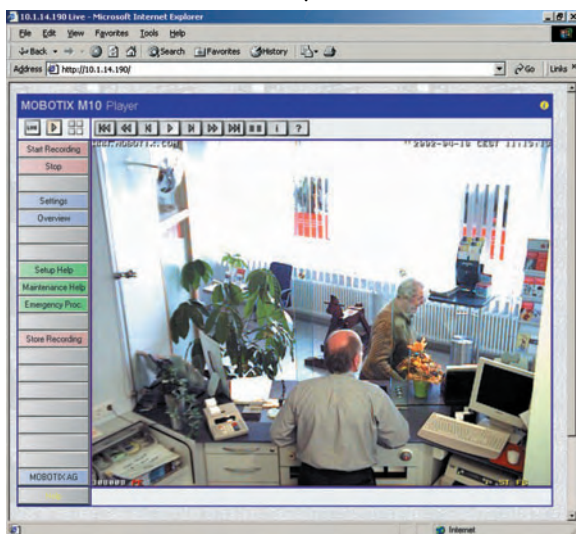

The live image of a bank scene (see figure) clearly shows the sunlight glaring through the window opposite the bank teller. This would "blind" a normal camera lens and render the area at the bottom of the image (faces, etc.) too dark to be of use. The MOBOTIX camera was configured on site, and selecting the predefined *Bottom* exposure window in

MOBOTIX cameras are **backlight-proof**



the lower third of the image solved this problem. The window in the upper half of the image thus has no effect on the exposure measurement, effectively eliminating the backlight.

#### 5.7.4 Automatic Exposure Setting Parameters

**Setup Menu > Exposure Setting** contains the following parameters that are relevant for exposure control. They can be set individually for the right and the left image sensor (if present).

- **Automatic Contrast:** If set to *Auto* (factory default), this parameter will automatically enhance contrast to avoid "flat" images.
- **Brightness:** This parameter adjusts the image brightness.
- **Backlight Correction:** This parameter improves images that contain bright and/or overexposed areas. A typical example would be a scene where a bright window is the main source of light. Objects located in front of it are displayed too dark and with too little detail.

Increasing the default value of 4 will increase overall illumination to properly display the dark image areas. This parameter offers the most advantages for high-contrast night images (see section 5.8, *Day & Night Modes*).

#### 5.7.5 Exposure Setting Options

In addition to the parameters of the automatic features, the following image enhancement options are available:

- **Night Improvement:** This parameter improves dark images (night images in particular, also see section 5.8, *Day & Night Modes*).
- **Exposure Window:** This parameter allows setting the positions of the exposure windows used by the automatic exposure control to determine exposure time and brightness.

The *Extra* option allows configuring customized exposure windows (see section 5.7.6, *Exposure Windows*).

If you set the **Show Window** option to *On*, the exposure windows are displayed in the camera's live image (green and red frames).

See further below for more information on adjusting the exposure windows and on white balance.

- **Max. Exposure Time:** This parameter sets the longest exposure time to be used by the camera. This parameter is extremely important since it has to provide for crisp images (short exposure time) on the one hand and for properly exposed noise-free night images (long exposure time) on the other hand.

For moving objects, it is recommended to use a minimum exposure time of 1/60 second. For still (non-moving) objects, a maximum exposure time of 1 second makes sense (64 times higher amount of light as compared to 1/60 second).

If possible, keep the factory default settings for the automatic contrast and brightness settings. For night images, you may set backlight correction to a value of 7 or 8

Exposure control can be adapted to the most difficult lighting conditions

- **Min. Exposure Time:** This parameter controls the minimum exposure time. It is recommended to leave the factory default unchanged.
- **Frequency of Power Supply:** Set this parameter to the frequency of your national electric system. The default value is *50 Hz* (e.g. France, Germany, etc.), but you can also select *60 Hz* (e.g. U.S.A., Japan, etc.). This will reduce most of the interference from artificial light sources. Note: Depending on the selected frequency, the defined maximum exposure time may vary slightly, e.g. *1/50 s* instead of the defined *1/60 s*.

Exposure Windows:

### 5.7.6 Exposure Windows

The concept of exposure windows is one of the most useful features of your MOBOTIX camera. This concept allows determining the correct exposure not only by evaluating the entire image area but by using special measurement windows that can be configured individually. You can choose to control the exposure time either by using one of the predefined exposure windows or by distributing this control between the exposure windows and the rest of the image. On top of this, you can also use *Exclusion Windows* (see section 5.7.9, *Exclusion Windows*) to exempt certain areas within the exposure windows from exposure control.

This concept also means that exposure is optimized for the important image areas regardless of the amount of backlight in the image area. This can be attributed to the fact that your MOBOTIX camera's exposure control is purely software-driven. It also means that the dark image parts of backlight situations can be better enhanced since there is no auto iris reducing the amount of light on the image sensor. **This is a one-of-a-kind feature for handling backlight situations.**

The example images show a typical situation: From a darker room, all individuals entering that room are to be captured. As daylight is influencing the lighting conditions in the neighboring room, backlight will have great influence on image exposure.

The image at the top has been recorded without exposure windows, meaning that the entire image area has been used for exposure control. Due to the significant differences in light, the bright image areas are overexposed and the dark walls are underexposed. Defining two exposure zones on both sides of the door (displayed in green, second image), results in proper exposure of this room's interior. An exposure window covering the area of the door (third image) will deliver properly exposed images of the other room.

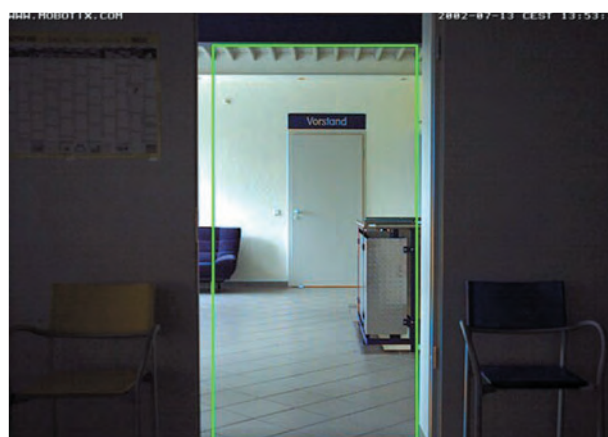
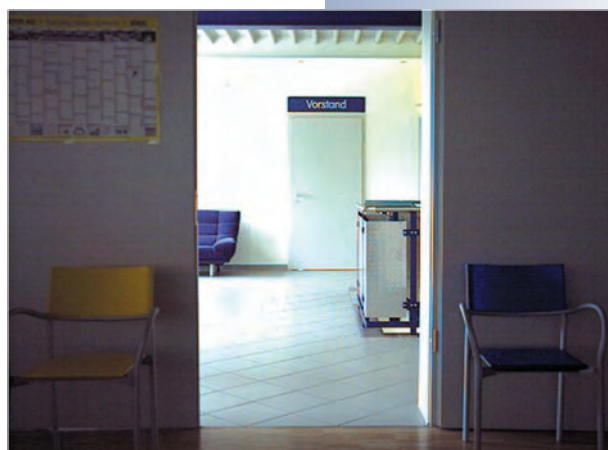

Flexible possibilities for adapting exposure control to the current situation

The task at hand determines which exposure control strategy to use. If you would like to capture images of individuals in the other room, you should use a vertical exposure window in the center (third image). If you would like to capture the faces of persons entering the room, these faces will receive the same amount of light as the room itself. In this case, the exposure windows to the left and right of the door (second image) would produce the best results. Even if the other room would be dark and a person would point a flashlight into the camera, the camera would not produce an overexposed (and thus, unusable) image, as the flashlight would not influence the exposure windows.

Use the pull-down menus in the live image to select the exposure windows.

### 5.7.7 Setting the Exposure Windows

**Setup Menu > Exposure Settings** contains a number of predefined **exposure windows**. Also, the areas within the exposure windows can be **weighted** against the areas outside of these windows using a separate parameter.

First, the automatic exposure feature determines the possible settings inside and outside of the exposure windows. Next, it evaluates the exposure according to the value set for **Exposure Weighting** (0% to 100%). If you select the *Total* option for the **Exposure Weighting** parameter, the entire image is used for exposure control, disregarding the exposure windows. You may also use the exposure windows for automatic white balance adjustment (see section 5.7.2, *Automatic Exposure*).

For testing purposes, it is recommended to temporarily display the exposure windows in the live image. If you set the **Show Window** option to *On* for the respective lens, the exposure windows are displayed by green frames in the camera's live image.

#### Exposure Window Parameters

The following exposure window parameters are only needed for adjustments in difficult situations. It is recommended to change these parameters only if other measures have not led to the desired results.

- **Exposure Weighting:** This parameter defines the weight (0% to 100%) that the exposure windows have for controlling **exposure** in relation to the rest of the image. The factory default setting of 100% means that only the exposure windows are used for exposure control.

Setting the weighting to *Total* will use the whole image area for exposure control, thus ignoring the exposure windows. This setting is useful if the exposure windows are to be used only for automatic white balance.

- **White Balance Weighting:** This parameter defines the weight (0% to 100%) that the exposure windows have for controlling **white balance** as compared to the rest of the image.

Setting the weighting to *Total* (factory default) will use the whole image area for white balance, thus ignoring the exposure windows. This setting is useful if the exposure windows are to be used only for automatic exposure.

If possible, keep the factory default settings for exposure weighting, white balance weighting and average brightness



Attribute	Left	Right	Explanation
Automatic Contrast	Auto	Auto	<b>Automatic Contrast:</b> Factory default: <i>Auto</i>
Brightness	0	0	<b>Brightness:</b> Factory default: <i>0</i>
Backlight Correction	4	4	<b>Backlight:</b> Factory default: <i>4</i>
Attribute	Left	Right	Explanation
Night Improvement	Auto	Auto	<b>Enable Night Improvement:</b> Amplification for dark images. Could increase image noise. <i>Auto</i> improvement is only used when MxPEG is <i>enabled</i> .
Lens F-Number	F/2.0	F/2.0	<b>F-Number:</b> The F-Number for illumination correction.
Exposure Field	All	All	<b>Measurement Field:</b> Define a region for the exposure control loop. <i>Extr</i> will use a window defined in the configuration file. Factory default: <i>All</i>
	100%	100%	<b>Exposure Weighting:</b> Weight between exposure field and the rest of the image for exposure control. Factory default: <i>100%</i>
	Total	Total	<b>White Balance Weighting:</b> Weight between exposure field and the rest of the image for white balance. Factory default: <i>Total</i>
	40%	40%	<b>Average Brightness:</b> Average brightness inside exposure field. Affects exposure time. Factory default: <i>40%</i>
	Off	Off	<b>Show Field:</b> Show measurement field as green and red box.
Exposure Time	Max 1/5	Max 1/5	<b>Max. Exposure Time:</b> Maximum exposure time in seconds (e.g. 1/90s = 11ms)
	Min 1/8000	Min 1/8000	<b>Min. Exposure Time:</b> Minimum exposure time in seconds (e.g. 1/90s = 11ms)
Frequency of Power Supply	50 Hz		<b>Line Frequency:</b> Select the frequency of your power supply to avoid interferences. Use 60 Hz for USA and Canada, 50 Hz for Europe. Factory default: <i>50Hz</i>
<b>Current Device Settings</b> Min. Time R=160 L=160 · Cur. Time R=357 L=10089 · Max. Time R=160000 L=160000 Exp. Corr. R=+0 L=+0 · Avg. Brightness R=400 L=400 · Line Freq.=50 Hz Reaction=Slow/42496 · Black Pixel=On · Gain Hyst.=On Exp. Field Weight R=100% L=100% · White Bal. Weight R=Total L=Total			

Dual and Night camera models accept different exposure windows for the two image sensors

Exposure windows can be customized for any situation

- **Average Brightness:** Use this parameter to set the average image brightness that should be reached within the exposure windows. If the maximum exposure time is insufficient, the camera software may actually use even lower values.

MOBOTIX cameras feature integrated white balance

**Note**

You may set different exposure windows for every zoom level. You could, for example, use the *Right* exposure window for 1x Zoom and the *Spot* exposure window for 4x Zoom.



MOBOTIX cameras support different exposure windows for different zoom levels of the digital zoom

### 5.7.8 Custom Exposure Windows (Extra)

In addition to the predefined exposure windows, you can also use customized exposure windows:

- Define the first corner point of the exposure window by Shift-clicking with your mouse in the live image; the  icon appears on that position.
- Define the second corner point of the image window diagonally across by **clicking** with your mouse in the live image (left-click).
- The camera draws a yellow frame that represents the custom exposure window. Next, select the *Extra* option for the **Exposure Window** parameter and click on **Add Rectangle** in order to add the coordinates of the new exposure window to the **Exposure Window Definitions** field. Clicking on the **Set** button will activate the new exposure window in the live image.

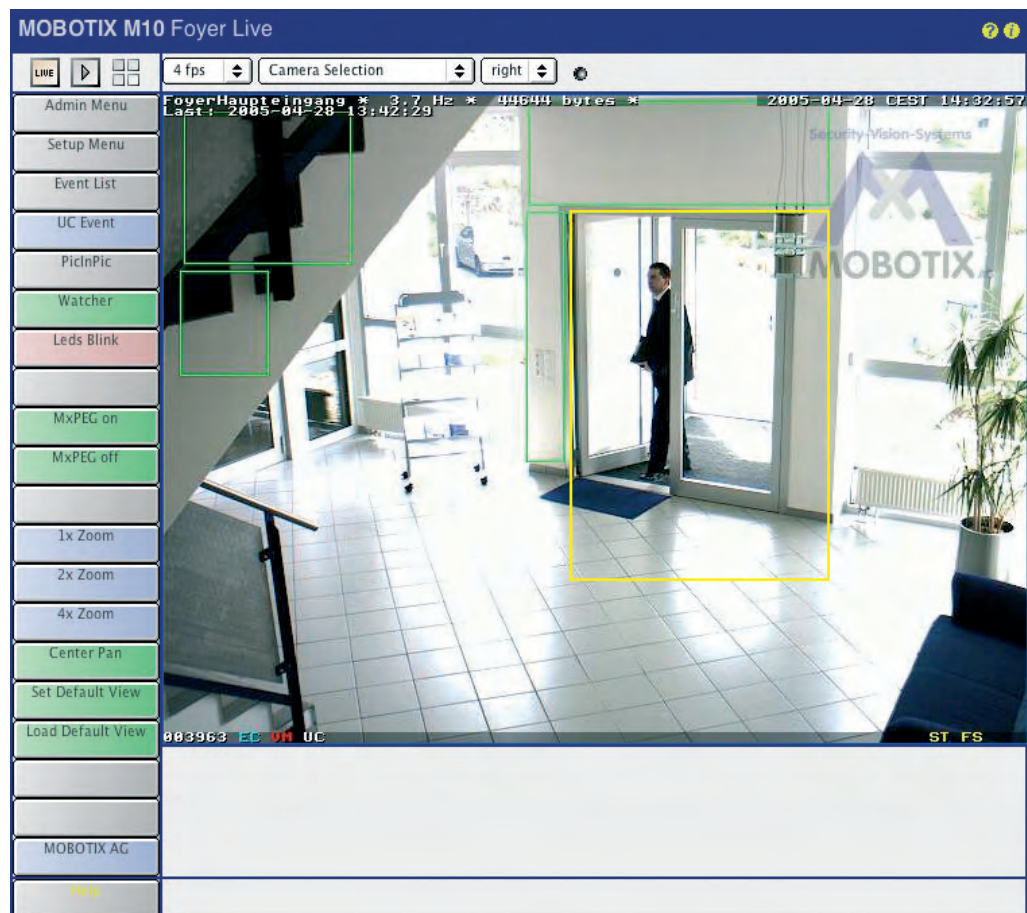

Yellow frame: Define measurement window using Shift-click, click

### 5.7.9 Exclusion Windows

In certain situations, you may want to exclude bright sources of light (e.g. street lights) from exposure control. In order to do so, you need to define the respective windows as described above in the *Custom Exposure Windows (Extra)* section. Next, add the `,out` parameter at the end of the definition lines to turn them into exclusion windows.

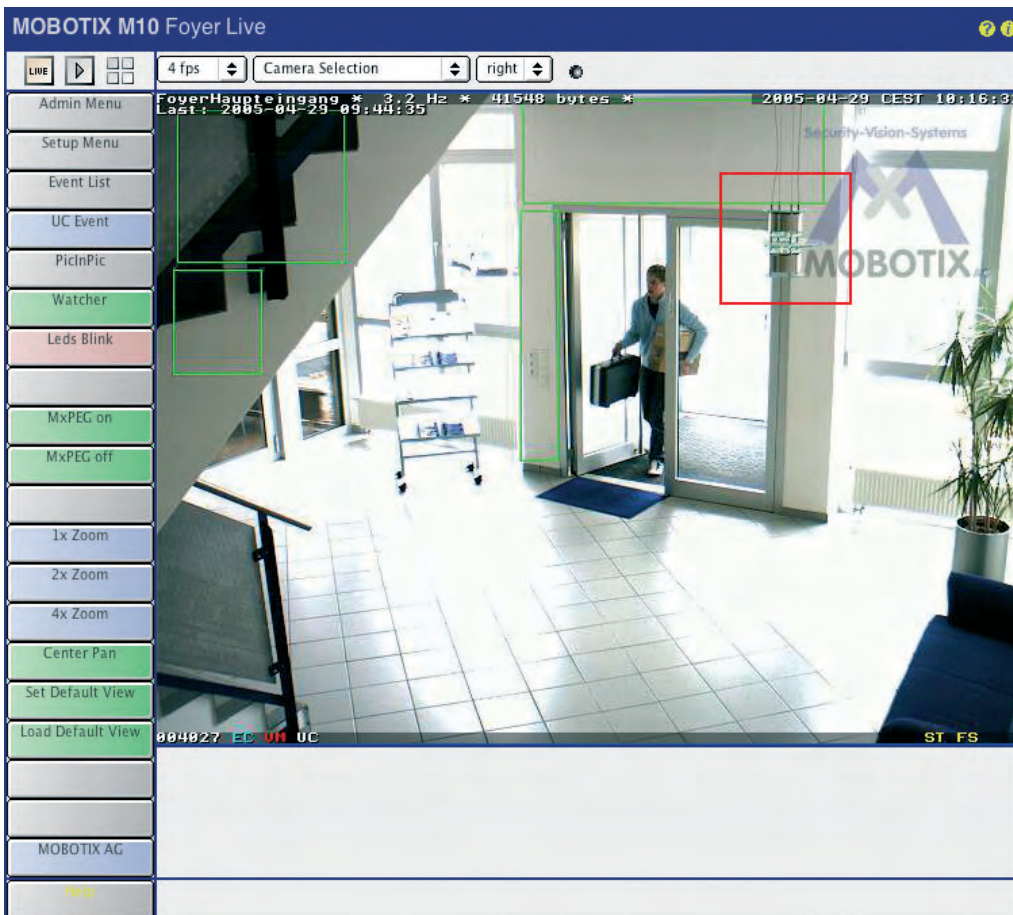

Exposure Windows:  
green frame

Exclusion Windows:  
red frame

If the exposure windows are displayed (**Show Window** set to *On*) the camera shows the defined exclusion windows with a **red frame**.

#### Example for a custom exposure window with an exclusion window:

```
# First, define the image area of the exposure window
0,100,100,900,800

# Next, define the exclusion window within the exposure window
0,800,700,50,50,out
```

#### Note

Lines starting with a **#** are indicating a comment and may be included in the **Exposure Window Definitions** field for documentation purposes.

## 5.8 Day & Night Modes

### 5.8.1 Overview

The MOBOTIX **Day/Night** camera models are equipped with one color and one B/W image sensor. Depending on the illumination of the scene, the camera uses either the color image sensor with daylight lens or the B/W image sensor with IR-sensitive lens to record the images. This provides for the best possible color images during the day and for crisp black/white images at night.

Kameramodell	X	-
X	-	-
X	-	X
-	X	-
-	X	X



The camera indicates which lens it is currently using by displaying a symbol in the lower right corner of the live image:

- **DY**: Day lens activated.
- **NI**: Night lens activated.

As per factory default, the camera automatically switches between the day and night lenses (**Setup Menu > General Image Settings > Camera Selection Auto**). Using the **Night Camera Level** parameter, you can define the switching threshold in lux (measured at the lens, factory default value is *10 lux*). The **Night Switch Delay** prevents the camera from switching too fast and thus avoids that the camera switches back and forth between lenses when the light values are close to the switching threshold (e.g. as caused by the light from a car's headlights briefly hitting the image sensors). Thanks to the night switch delay, the camera reacts to changes in illumination only after it detects illumination higher or lower than the defined threshold value for more than 10 seconds.

**Note:** You can define different exposure windows for the day and night lenses. For additional information on this topic, see section 5.7.6, *Exposure Windows*.

Night models:  
Image sensor has to be set to **Auto** to enable automatic Day/Night switching

### 5.8.2 Reduction of Dark Noise

Growing darkness may result in the image quality getting poorer (*dark noise*). The *Noise Suppression* parameter minimizes this effect (**Setup Menu > General Image Settings**). The maximum exposure time (**Setup Menu > Exposure Settings > Maximum Exposure Time**) also influences dark noise. The shorter your maximum exposure time is, the earlier you will experience dark noise.

#### Note

When using video motion detection at night, make sure that image noise (individual pixels in the image that change color) does not lead to unintended triggering of the motion detection windows. Open **Setup Menu > Event Settings** and set the **Video Motion Night Mode** parameter to a value that disables video motion detection when the illumination falls below the chosen level. As an alternative, you could increase the area parameter of all video motion definitions. We recommend testing this function under real conditions.

### 5.8.3 Configuration Hints

In order to obtain high-quality, crisp day and night images it is recommended to set the maximum exposure time for both lenses to a short value (e.g. *Max 1/60* second; **Setup Menu > Exposure Settings**). For non-moving objects, you can set the maximum exposure time to a higher value (e.g. *Max 1/1* second). Note that you can set different values for the two lenses. By factory default, this setting is 1/30 and 1/5 second, respectively.

In addition, you can set the **Backlight Correction** value for the B/W lens (left) to e.g. *8* (**Setup Menu > Exposure Settings**). This setting guarantees for high-quality results in lighting situations with strong contrasts at night (e.g. with street lights present).

When setting the **Night Improve** parameter (**Setup Menu > Exposure Settings**) to *On*, dark images are further improved. This may, however, result in increased image noise. It is recommended that you test the **Night Improve** and **Dark Noise Suppress** features using different parameters under real conditions.

Dark noise reduction for improved image quality in situations where light is fading





The camera's configuration file contains all configuration data

 In Admin Menu = reboot required

Configuration options

## 5.9 Managing Settings

### 5.9.1 Overview

All settings of the MOBOTIX camera are stored in the configuration file. Using the options under **Admin Menu > Configuration**, you can manage these configuration settings. For example, you can edit the configuration file, save it on your local computer, load and transfer saved configuration data and copy configuration data from other MOBOTIX cameras. Also, you can **automatically transfer the configuration** (or individual portions such as image or event settings) of one MOBOTIX camera **to several other cameras at the same time (Manage other cameras)**. This saves a lot of time when setting up a multi-camera system.

In addition, all camera settings can be reset to the factory defaults (including the user data and the respective passwords).

### 5.9.2 The Configuration File

#### Note

In order to change the camera configuration, you need to log in as a user of the **admins** group.

The configuration file is read once at boot time and then copied to the camera's RAM. Any changes in the camera's configuration dialogs will only be performed on this locally stored copy of the configuration file, making any change temporary until the next system reboot/restart. To permanently store the settings, you need to save the configuration data in the camera's permanent flash memory (**Admin Menu > Store**).

#### Note

Some changes, especially to **interface settings** (IP address, ISDN settings, external image storage on file server, etc.) will only be activated when rebooting the camera. Most of the other settings (e.g. image and event settings) are used immediately after you have changed the corresponding options.

For working with configuration files, the following options are available:

- **Store:** Copies the current configuration file to the camera's permanent flash memory. This is the normal way to save changed parameters, which are to be stored beyond the next system reboot/restart.
- **Reset:** Replaces the active configuration data with the factory default configuration. In order to save the parameters for the next system reboot/restart, you also need to execute the **Store** option.
- **Restore:** Retrieves the last stored configuration data from the flash memory. This can be helpful, for example, if you have booted a camera using the factory default IP address (see section 3.6, *Starting the Camera Using the Fac-*

factory IP Address, in the *Camera Manual*) but still want to use your previously defined configuration.

- **Load:** Loads a configuration file (or certain portions of it) stored on a local computer into the camera (see section 5.9.3, *Loading Configuration Files*).
- **Save:** Saves the current configuration file from the camera's RAM to a local computer. You can open the configuration file using a text editor (never use a word processor!). Be careful when editing the file directly in the text editor.
- **Show:** Displays the active configuration file.
- **Edit:** Allows editing the current configuration file directly in the browser.
- **Manage:** Allows automatically transferring the configuration settings from one MOBOTIX camera **to several other cameras at the same time**.



Only for experts!

Managing camera configurations

**Warning:** Only change your configuration file if you know what you are doing. Invalid settings or uploading a corrupt configuration file may result in losing the connection to the camera, requiring you to reboot it using the factory defaults (see section 3.6, *Starting the Camera Using the Factory IP Address*, in the *Camera Manual*).

**Note:** Thanks to the Time Tasks feature, you can automatically restore the last saved configuration at scheduled intervals. This allows to temporarily change individual settings (e.g. by a user directly accessing the camera from the Internet) without permanently storing these settings in the camera. For additional information on this topic, see section 7.9, *Time Tasks*

Configuration files can be copied to other MOBOTIX cameras

Protect sections by activating the corresponding checkboxes

**Caution: Deactivate popup blockers!**

The **Networking** and **Security (users, passwords)** should always be protected!

### 5.9.3 Loading Configuration Files

**Admin Menu > Load** allows uploading a previously saved configuration file from a local computer to your camera. Click on **Select Upload File** to select the desired file, then click on **Upload**.

The configuration file consists of several sections that can be uploaded individually. When uploading, you can either replace the entire configuration (*Replace the current configuration completely*) or leave parts of the current configuration untouched (*Everything except the parts checked below*). Using this procedure would allow you to load the image and event settings while keeping the current network settings, for example.

**You can prevent the following sections from being replaced:**

- **Security (users/passwords):** Contains the passwords for the users of all groups **admins**, **users**, **guests**, ...) as well as the group definitions.
- **Networking:** Contains all network and ISDN parameters.
- **Transfer Profiles:** Contains all e-mail and FTP profiles.
- **File Server:** Contains the settings for saving image/video data in an external ring buffer.
- **Time Tasks:** Contains the settings for time tasks.
- **Logos:** Contains the settings for displaying logos in the camera images.
- **Audio (settings, call profiles):** Contains the audio and telephone profiles and settings.
- **Page (language, softbuttons, MultiView):** Contains the settings for language, softbutton and MultiView configurations.
- **Image Control:** Contains the settings for image control.
- **Event Control:** Contains the settings for the entire event control (events, actions, messages, recordings).
- **Camera (time server, LEDs):** Contains the camera settings (time, date, LED configuration).
- **Serial Interface (modem, data):** Contains the RS232 interface settings.

**Caution:** If you have not protected the **Networking** section before merging the configuration, the camera will use the network configuration of the loaded file, which may have a different IP address. In this case, you will not be able to access the camera using its current IP address. To prevent this from happening, you should protect the **Networking** section.

If you have not protected the **Security (users/passwords)** section before merging the configuration, the MOBOTIX camera to which the configuration file is uploaded will be assigned the same user names and passwords as the MOBOTIX camera from which the configuration file has originated. Passwords are saved encrypted in the configuration file, so you need to make extra sure that you know the passwords. In case you do not have the administrator password, the administration area of the MOBOTIX camera will remain inaccessible. To prevent this from happening, you should also protect the **Security (users, passwords)** section.

### 5.9.4 Copying Configuration Files to Other Cameras

**Admin Menu > Manage** allows copying the configuration file of your MOBOTIX camera to one or several other cameras at the same time (*Copy configuration to the selected cameras*), provided that the other cameras are listed on this page (*Search for new cameras on the subnet*; see section 4.5.2, *Defining Cameras*). In the following dialog, you can select the configuration sections you would like to copy (see figure).

For security reasons, you will be prompted to enter an administration user name of the target camera and the corresponding password.

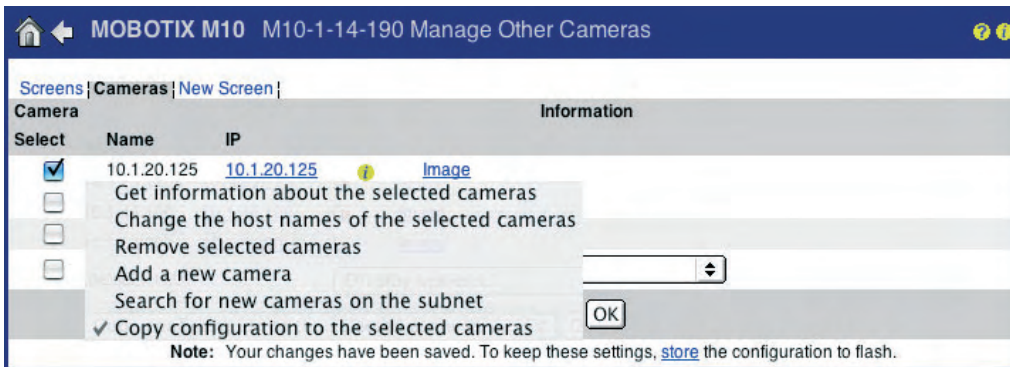

**Manage Other Cameras** allows copying configuration files to other cameras

#### Note

When copying the configuration file to other cameras, you should make sure that the source and the target cameras are of the **same model with identical software versions**.



Software updates are  
**free**

Sample download file:  
M12\_system\_de\_2\_232.mpl  
approx. 7.6 MB

Carefully follow these  
instructions!

## 6 SOFTWARE UPDATES

### 6.1 Overview

A **web browser** is the only tool required to update the software of a MOBOTIX camera and to make the latest features available. To update the camera software, you can either use an Ethernet or an ISDN connection. Using an Ethernet connection is the preferred method as this considerably reduces upload time and is less error-prone than using an ISDN connection. **The safest method for updating your camera software is to establish a direct connection between your computer and the MOBOTIX camera.**

Download the suitable update file (.mpl) for your MOBOTIX camera model **free of charge** from [www.mobotix.com](http://www.mobotix.com). Prior to downloading the file, you need to make sure that you know the exact model name and current software version of your camera. If you have an older camera model, you also need to know the size of its RAM. To display this information, click on the (i) icon (factory default IP address, software version and hardware). You will also find this information by opening **Admin Menu > Hardware and Release Information**.

#### Caution

**Make sure you read and understand the release notes and the readme information for updating the camera software on [www.mobotix.com](http://www.mobotix.com).** MOBOTIX is not liable for any errors incurred by applying unsuitable software versions or for errors that can be attributed to ignoring the supplied information.

### 6.2 Preparatory Steps

Prior to updating your software, make sure to have checked for and eliminated these possible causes for errors:

- (1) **Deactivate the browser cache:** Deactivate your browser's cache and delete all stored data (Clear Cache). This prevents the camera from accessing older (outdated) cache data.

Example: Deactivate the cache in Internet Explorer. On the **Tools > Internet Settings > General > Settings** tab, check the *Every visit to the page* option. To empty the cache, open the **Tools > Internet Settings > General** tab and click on **Delete Files**.

- (2) **Deactivate proxy servers:** Deactivate any previously defined proxy servers. They function as intermediate storage for files (similar to a browser cache) and may prevent direct communication with the camera. You can either deactivate the proxy servers in the Internet Explorer in **Tools > Internet Settings > Connections > LAN Settings** or add the camera's IP address to the list of proxy exceptions.

- (3) **Deactivate popup blockers:** Deactivate any popup blockers that may be active in your browser (see below). In most modern browsers, popup blockers are activated by default (Internet Explorer, Safari, Firefox) or additional software applications take care of this problem (e.g. Google Toolbar). When working with the camera, popup blockers prevent that dialogs are opened during the software update. **With active popup blockers, the software update will not work properly.**
- (4) **Reboot browser and camera:** Close all browser windows and restart your browser before you continue.

Restart the camera (**Admin Menu > Reboot Camera**). This makes sure that the camera is in a defined and stable state when starting the software update.

## 6.3 Updating the Camera Software

Updating the software involves the following steps:

- (1) **Downloading the software from the Internet:** Download the update file (.mpl file) for your respective camera from [www.mobotix.com](http://www.mobotix.com).

Read the notes in the **readme file**.

- (2) **Uploading the software to the camera:** Check the camera's current software release version (Info button (i) in the title bar of your camera's Live screen).

Read the notes in the **Admin Menu > Update System Software** dialog. Then, follow the instructions for updating the software.

**Avoid any power failure or network disconnect while uploading the software as this can damage the firmware in the camera.**

Once you have started the software update, avoid interrupting or stopping the process. Do not perform additional actions in your browser, do not load another website at the same time and do not close any browser windows.

During the update process, the camera LEDs are running a pattern in a clockwise manner, sometimes all LEDs are blinking. The status information of the upload process is displayed in a popup window of the browser (see figure). Wait until the camera software prompts you for further actions.



```

Log of System Upload (M10-1-14-190)

Factory IP: 10.1.14.190
Current date: 2006-01-31 15:25 CET

91% (Reading part 8 of 9)

MOBOTIX M10: UPLOAD OF SYSTEM SOFTWARE
New: 25451001; 1-00-0 of 00A9; 2004/04/26 11:22:59.9
*** W A R N I N G ***
*** While uploading system software:
*** - Avoid any power failure!
*** - Do not close or change any browser window.
*** - DISCONNECTION MAY DAMAGE THE SOFTWARE IN YOUR CAMERA.
*****
Flashing data from 0000
Checking file=ID:
100% read of 527 Kbytes into Ram, Part 1/9
100% read of 670 Kbytes into Ram, Part 2/9
100% read of 88 Kbytes into Ram, Part 3/9
100% read of 20 Kbytes into Ram, Part 4/9
100% read of 14 Kbytes into Ram, Part 5/9
100% read of 264 Kbytes into Ram, Part 6/9
100% read of 16 Kbytes into Ram, Part 7/9
100% read of 1820 Kbytes into Ram, Part 8/9
100% read of 377 Kbytes into Ram, Part 9/9
W O R N I N G: Flushing of part 1 will take about 189 sec.
While flashing windows will not be updated.
be patient...
  
```

Never interrupt the update process!

- (3) **Rebooting the camera:** Reboot your camera only when the camera software has prompted you to do so. The software update will only be effective after the camera has rebooted. During the reboot, the new software is transferred from the flash memory to the camera's RAM.
- (4) **Updating the configuration file:** After you have rebooted your camera, you are prompted to open the page for updating your configuration file. This update is necessary to make sure that all affected sections of the configuration file are automatically adapted to the new software version.

**Caution**

**You may choose to reset the configuration as a whole, but this means losing all previous settings, including the network settings.**

In order to leave certain parts of the configuration untouched, you can activate the **Everything except the parts checked below** option. By default, the sections **Security** and **Networking** are already checked and thus will *not* be replaced. If you are not sure which portions to protect, it is recommended to activate all checkboxes in order to leave all sections in their current state.

Afterwards, click on **Reset** to reset the configuration.

- (5) **Saving the configuration and rebooting the camera:** Save your configuration in the camera's flash memory.

After rebooting, the camera is ready for action again.

Finally, check if the camera's current software release version is identical to the version of the newly loaded update software (Info button **(i)** in the title bar).

**Caution**

If an **error** occurs while updating the camera software, **do not** reboot, but restart the update process from **step (2)**.

If this attempt fails, reboot the camera. After rebooting, the camera will recognize the problem with the failed upload and will boot its **backup operating system** and the old configuration. You can now restart the update process.

Make sure that you restore the browser settings for caching and the proxy server once you have successfully updated the camera software.

The integrated backup operating system makes updating the software safe, even if the connection is interrupted

### 6.4 Update Checklist

#### Before the Update

- Did you write down the current software release version and the RAM size?
- Did you download the correct software?
- Did you write down the browser cache and proxy settings?
- Did you clear the browser cache?
- Did you deactivate the browser cache and proxy server?
- Did you deactivate all popup blockers?
- Did you reboot the camera?

#### During the Update

- Never interrupt the data connection and never unplug the power supply!
- Do not close any browser windows!
- Wait for the camera to complete the update!

#### After the Update

- Did you reboot the camera?
- Did you update the configuration file? Did you protect all relevant sections?
- Did you restore the browser cache and proxy settings?
- Did you reactivate the popup blockers?



## 7 EVENTS, ACTIONS AND MESSAGES

### 7.1 Overview

This chapter covers the MOBOTIX camera's integrated sensors and the camera's ability to detect **events** and to carry out **actions**. MOBOTIX cameras have set the mark where functionality and flexibility of network cameras are concerned. When used in **security applications**, MOBOTIX cameras create dependable yet inexpensive solutions that could not have been implemented (let alone financed) without them.

But MOBOTIX cameras also sport innovative features that can be invaluable in other areas. The cameras can post images on the web as **webcams** around the clock, they can fulfill monitoring tasks (such as counting packages on a conveyor belt) and other tasks in **industrial applications** at **reasonable** costs.

The **concept** is as simple as it is unique: Every camera detects **events** and evaluates these events. If these events have been linked to **actions** or **messages**, these will be executed or sent automatically once the corresponding events have been detected. Additional conditions allow handling more complex combinations of events, allowing the camera to react to specific events and to event combinations or sequences.

MOBOTIX cameras can also be used to check conveyor belts, for example

Events can trigger actions and messages

MOBOTIX system diagramm

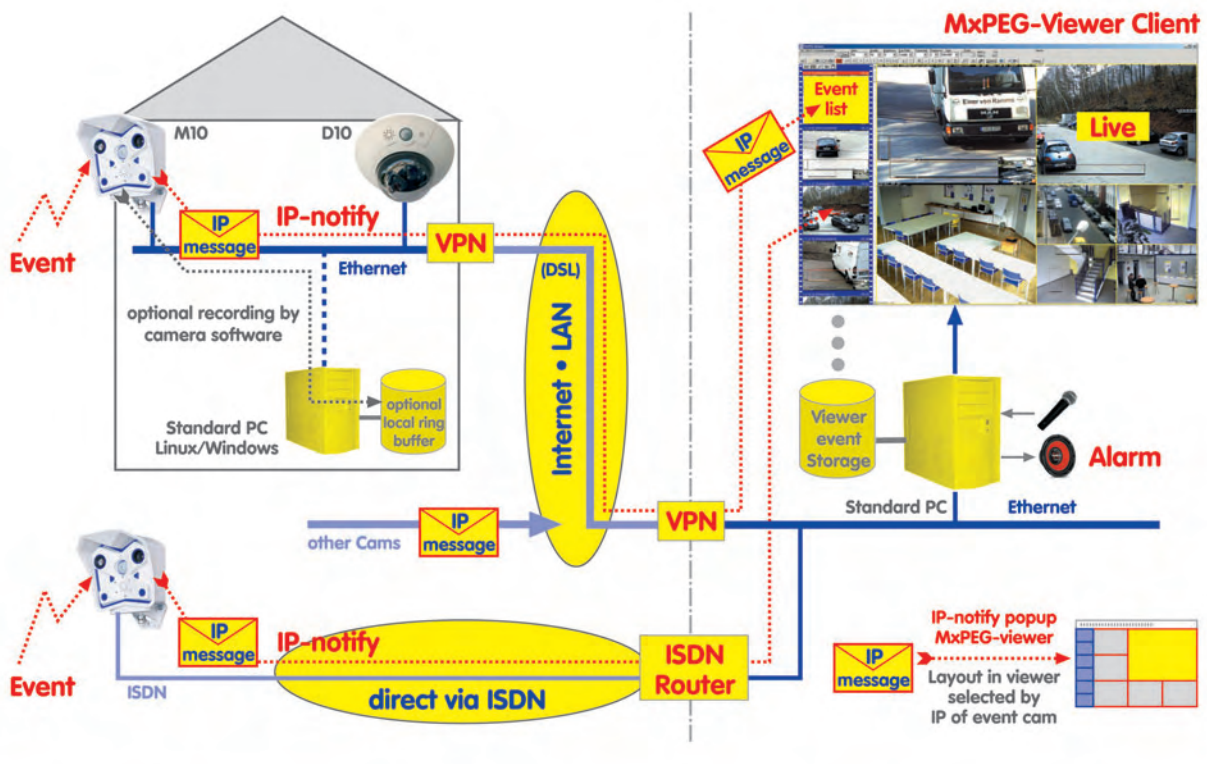

#### The Alarm Concept: Decentralized and Intelligent

Similar to the recording features described in chapter 8, solutions using MOBOTIX cameras benefit from the **decentralized approach**: No central computer that evaluates the cameras data, but many small and flexible units that are working hand in hand in an intelligent manner. While a centralized system fails completely if

the control center computer fails, MOBOTIX cameras are still capable of placing alarm phone calls autonomously, for example.

If the **Time Tables** are engaged for activating and deactivating the camera's event control (or parts thereof) according to opening hours and vacation times, for example, the resulting video surveillance system is easily adapted to the requirements of the installation.

### Internal Sensors: Complete, Yet Expandable

Besides the image sensors and the integrated video motion detection, MOBOTIX cameras feature other physical sensors (PIR sensor, microphone, internal temperature, etc.), which can trigger events. The camera's *logical* sensors round off the picture as they can be used for further detection tasks: Hence, the camera can send an e-mail with an attached live image for testing purposes if the illumination falls below a certain level or it may call you if an event recording has been completed.

The integrated signal input lines further extend these capabilities as these inputs can be used to integrate external sensors (light barriers, external PIR sensors, switches, etc.).

### Actions and Messages: Reacting Flexibly to Events

If the MOBOTIX camera detects an event, it can execute **actions** and send **messages**. In order to react differently when detecting different events, you can set several message paths for the camera, for instance. This could mean that the PIR sensor switches on the lamps using the signal output, while the alert message via email or phone call is only sent if the video motion windows detect movements within the illuminated scene.

Actions and messages can also be controlled using Time Tables; this allows adjusting the action and messaging features to the application tasks at hand.

### Event Logic and Event Counter: Filtering Events

The **event counter** is an event filter that prevents the camera from immediately executing an action or sending a message; it will only do so if a certain number of the selected events occur within the specified timeframe.

The **event logic** allows combining actions and messages and will only execute alarm actions or send messages if two events occur in a specific order. For instance, when using two different video motion windows, these would only trigger an event if a person would walk through the detection windows from right to left but not vice versa. Combining these features with the signal inputs and external sensors will cover nearly any kind of application scenario.



Using external sensors

Phone call in case of an alarm



Evaluation of the direction of movement of vehicles or persons

Individual possibilities when configuring alarms

## 7.2 Functional Overview

MOBOTIX cameras are unique in their ability to execute actions or to send messages once they are detecting events from one of their integrated sensors. When detecting movements in the image, for example, the camera software can start recording video and audio, it can play an alarm on the integrated speaker, send the recorded video as an email attachment and call the control center. All of these actions and messages can occur simultaneously or with adjustable delays.

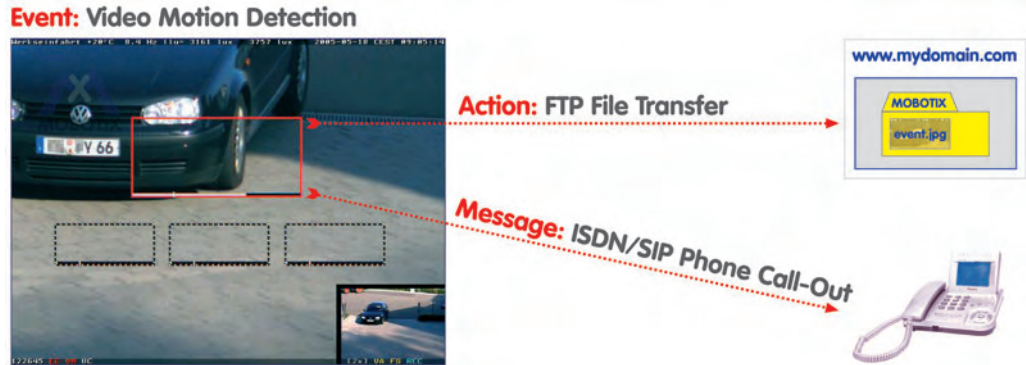

Use the dialogs grouped in **Setup Menu > Event Control** to configure the events, actions and messages of the MOBOTIX camera:

1. Arm the camera
2. Configure events and sensors
3. Configure actions and messages

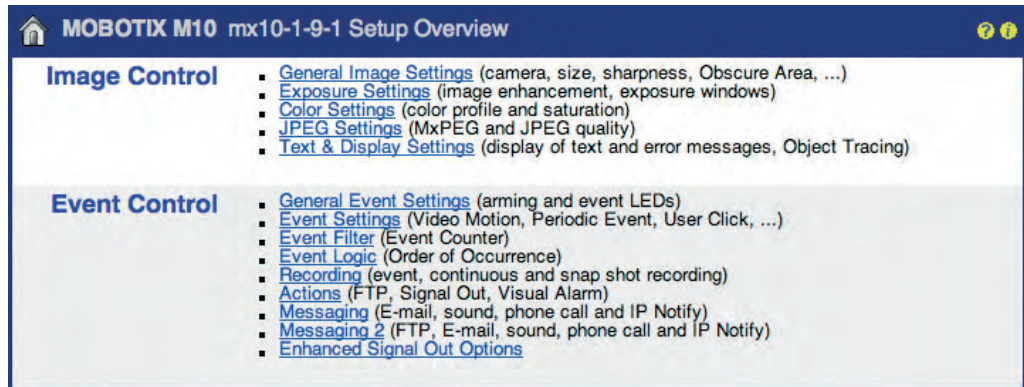

- **General Event Settings:** (Section 7.5, *Arming*) This dialog controls the camera's arming, which in turn activates event evaluation, actions, messaging and video recording.
- **Event Settings:** (Section 7.6, *Events*) This dialog configures the camera's sensors and allows activating the corresponding events.
- **Actions:** (section 7.7) This dialog controls the camera's actions (signal output, FTP, visual alarm in the live image), which the camera can execute upon detecting an event.
- **Messaging:** (section 7.7) This dialog controls the camera's messages (sound on event, e-mail, phone call, network message), which the camera can send upon detecting an event.

Kameramodel	X	-
Kameramodel	X	-
Kameramodel	-	X
Kameramodel	-	X

Kameramodel	X	-
Kameramodel	X	-
Kameramodel	-	X
Kameramodel	-	X



- **Messaging 2:** This dialog allows configuring additional actions and messages. The settings in this dialog are used to create a second messaging path for assigning different actions and messages to different set of events.
- **Recording:** This dialog allows setting the type and format of the video recording (JPEG snap shot recording, event recording (MxPEG video), MxPEG continuous recording, with or without sound, image sequence parameters, etc.). For additional information on this topic, see chapter 8, *Recording*.
- **Event Filter:** (section 7.6.3) This dialog configures the camera's event filter. The filter's event counter will only trigger an event (and subsequently, actions and messages) if a specific number of events within the specified timeframe is either surpassed or not reached.
- **Event Logic:** (Section 7.6.4) This feature provides a method of triggering an event only if two other selectable events or event sets occur within the specified timeframe. For example, if a video motion (VM) event is detected, an automatic alarm or phone call will only be triggered if the security guards hit an alarm switch within 10 seconds.
- **Signal Out Action:** Use this dialog to select the events, which will only activate the signal output switch of the camera.

Kameramodal	
X	-
X	-
-	X
-	X

Event can be linked logically for enhanced event detection

Kameramodal	
X	-
X	-
-	X
-	X

Predefined video motion window (dotted square; factory default)

### 7.3 General Procedure

By factory default, the MOBOTIX camera is **not armed**; it needs to be armed first before proceeding. The easiest way to arm the camera is to use the enhanced **Arm & Record** softbutton (see also section 4.3.1, *Controls*). To arm the camera manually, open the **Setup Menu > General Event Settings** and **Event Settings** dialogs.

Arming the camera will also activate the predefined **video motion window** event (**VM**, dotted square at center of the image) and the **user click** event (**UC Event** softbutton). When connected to the power supply, every MOBOTIX camera records images in the internal image storage as soon as the camera detects movements within the video motion (**VM**) window. To trigger video recording manually, click on the **UC Event (UC)** softbutton of the Live screen.

Arming the camera, however, will **not assign any** actions or messages to the alarms (events). Actions and messages are to be configured as described in section 7.7, *Actions and Messages, Action and Message Profiles*.





The camera archives detected events in its internal image storage

#### Procedure!

**Note**

By **factory default**, the recorded images are stored in the internal image storage of the MOBOTIX camera. For additional information on this topic, see chapter 8, *Recording*.

In essence, you need to **follow this procedure** for configuring actions and messages for events:

- **Step 1:** Activate the camera's arming switch (**Setup Menu > General Event Settings**); see section 7.5, *Arming*.
- **Step 2:** Activate and configure the desired events (**Setup Menu > Event Settings**); see section 7.6, *Events*.
- **Step 3:** Activate, configure and assign an action or a message to this event and configure the corresponding action or message profile (**Setup Menu > Actions** or **Setup Menu > Messaging**); see section 7.7, *Actions and Messages, Action and Message Profiles*.

**Note**

The camera's arming status as well as individual actions and messages can be controlled using the **time table** profiles (exact date/time) or they can be controlled by one of the **signal inputs (SI Low/SI High)**, using a key switch, for example. For additional information on this topic, see sections 7.5, *Time Tasks*, and 7.8.6, *Time Tables*.

## 7.4 Screen Display of Event Settings in Live Image

All activated events, actions and messages are displayed at the bottom of the camera's live image (**Setup Menu > Text and Display Settings > Display Options: Symbols**). Activated **events** (event symbols) are displayed at the bottom **left** corner, activated **actions** and **messages** (action and message symbols) are displayed at the bottom **right** corner. Likewise, the status of the recording feature is displayed at the bottom right corner.

Activated Events, Actions and Messages are displayed as symbols in the live image

#### Event Symbols:

UC = User Click  
VM = Video Motion detection

#### Action Symbols:

VA: Visual Alarm  
REC: Recording  
FS: File Server  
FT: FTP file transfer

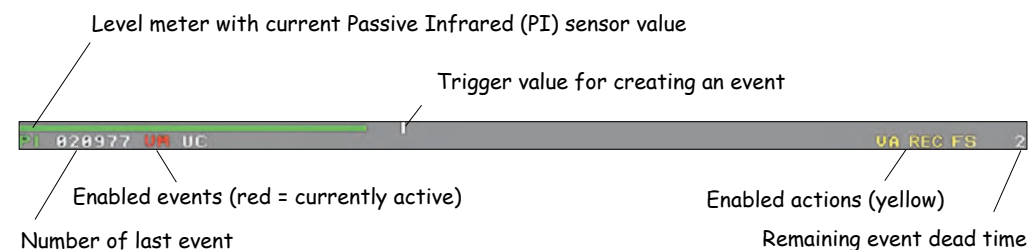

For example, the **VM UC** symbols show that the **Video Motion** and **User Click** events have been activated. The **SD** and **VA** symbols indicate activated **Sound on Event** and **Visual Alarm** actions/messages. The **REC** symbol is displayed if

**Recording** has been activated and **FS** indicates external image storage on a **file server**.

The symbols may assume different colors, thus indicating their status:

- **Event symbols** are red upon detection of an event and white otherwise.

Status	Color	Example	Event
Activated	White	UC	User Click
Executing	Aqua	UC	User Click
Deactivated	Gray	UC	User Click

- **Action and message symbols** are turquoise if an action or message is carried out, red if an action or message failed (e.g. an uncompleted phone call), and yellow otherwise. The symbols will turn grey if the action or message profile has been deactivated (either manually or from a Time Table profile).

For failed actions, messages or recording, a yellow error message will appear above the symbols (**Setup Menu > Text and Display Settings > Error Messages**).

If you have selected a Time Table profile in **Setup Menu > General Event Settings** to control the camera's arming, the additional **off** string in the bottom right corner of the live image will signal that the camera has been temporarily disarmed by a Time Table profile. If this is the case, all action, message and recording symbols will be shown in gray.

Status	Color	Example	Action/Message
Activated	Yellow	EM	E-Mail
Executing	Aqua	EM	E-Mail
Deactivated	Gray	EM	E-Mail
Error	Red	EM	E-Mail

#### Caution

If the camera's arming has been deactivated in **Setup Menu > General Event Settings (Off)**, all event, action and recording symbols are missing from the live image.

For a complete list of all symbols and color codes, see the camera help and the reference manual.

Activate the MOBOTIX camera's **main arming switch** to use the alarm features of the camera

## 7.5 Arming

The **Setup Menu > General Event Settings** dialog contains the camera's main arming switch, which switches all events, actions, messages and recording features of the camera on or off. In addition, you can configure the **Master/Slave mode** and the custom signals in this dialog, which allow the camera to synchronize its arming status with that of another MOBOTIX camera.

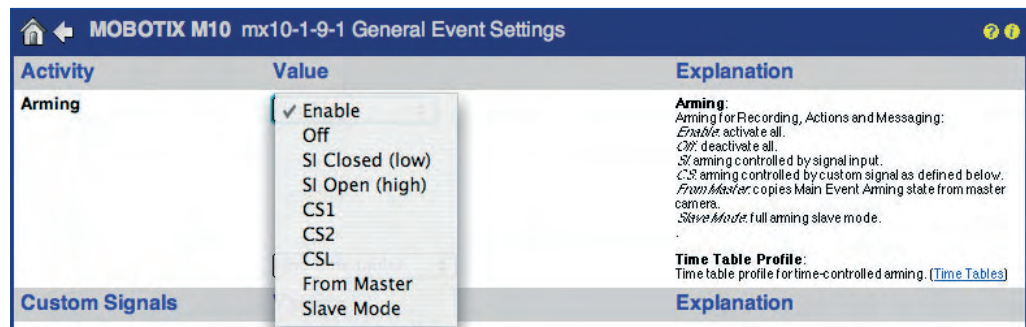

### Caution

**A camera, which has been disarmed in this dialog will not record any video or audio data, it will not register any events nor will it perform any actions or messages.** Likewise, the camera will not display any symbols of the event control at the bottom of the camera's live image if it is disarmed. In this case, no event, action, message or recording symbols are visible.

Note that the main arming switch of the camera *does not* influence the **Time Tasks**. These tasks will be executed, even if the camera is disarmed.

Time Tasks are active even if Arming has been deactivated!

The arming status of a MOBOTIX camera can be controlled using the following mechanisms:

- **Manual arming**  
The camera is either armed (*Enable* option) or not (*Off* option). These settings work like an On/Off switch.
- **Arming controlled by a time table**  
The arming status of the camera is based on a schedule: The camera is armed only if a time range in the selected time table profile is active. On the other hand, if no time range in the selected time table profile is active, the camera is not armed.

This option allows controlling the arming of a MOBOTIX camera in a very convenient manner, as you can easily adapt camera arming to opening hours, holidays and vacation times. To use this feature, set Arming to *Enable* and select the time table profile you defined beforehand.

For additional information on this topic, see section 7.8.6, *Time Tables*.



Arming controlled by a **time table**

Set Arming to *Enable*!

- **Arming controlled by signal input**

The camera's arming status is based on the signal input status. Depending on the selected option, the camera is armed if the signal input line is closed (*SI Closed (low)* option) or if the signal input line is open (*SI Open (high)* option). If the signal input line has the opposite status, the camera is not armed.

This feature allows using a key switch or the main switch of an alarm system to arm one or more MOBOTIX cameras. The signal input may also be used to arm the camera permanently after an alarm button has been pressed (e.g. bank teller).

If a **time table profile** has been selected as well, the camera is only armed if the signal input line has the selected status **and** one of the time ranges of the time table profile is active.

- **Controlling the arming status using a Master camera**

Selecting the *From Master* option will copy the arming status of a MOBOTIX camera from that of another MOBOTIX camera, the **Master camera**. Note that it is of no importance, why the Master camera is armed.

Every MOBOTIX camera, for which **Arming** has been set to the *From Master* option (**Slave camera**), will register with the Master camera once (and again periodically) if the **Enable Master/Slave** has been properly configured. Every time the Master camera changes its arming status, it will send this status (*armed or not armed*) to the registered Slave cameras.



Arming controlled by signal input



Controlling the Arming status using a Master camera

The *From Master* option can also be set in these dialogs:

- Recording
- Actions
- Messages
- Messaging 2

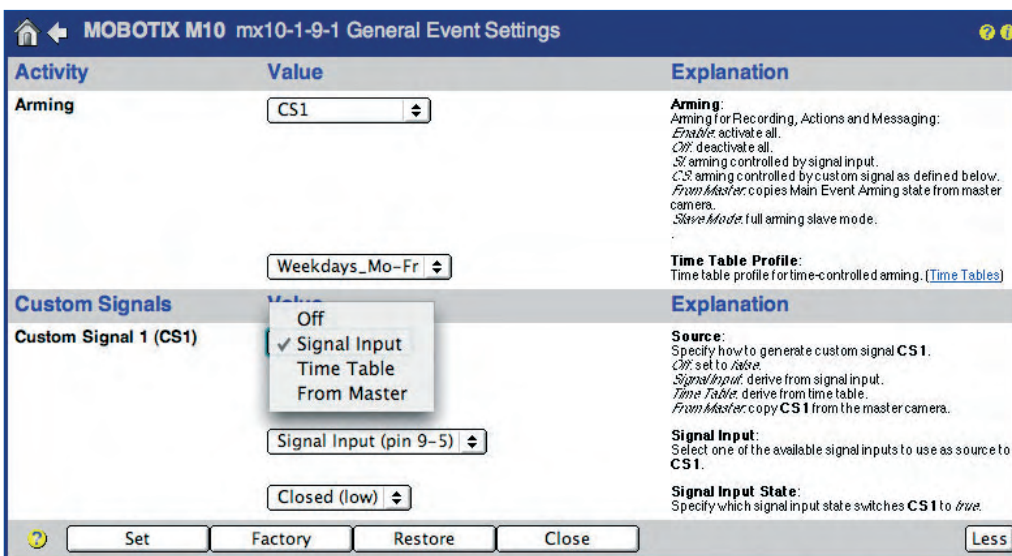



Kameramodell	
X	-
X	-
-	X
-	X

Arming: The **Slave mode** copies **all Arming settings** from the Master camera

Kameramodell	
X	-
X	-
-	X
-	X

Arming control using **custom signals**

The Master camera, on the other hand, will control the registered cameras from time to time. This will ensure that the Master camera recognizes if a registered Slave camera is missing.

If the Master camera should fail, the registered Slave cameras will automatically switch to *armed* for security reasons. In addition, the alarm center can be alerted that the Master camera has failed (e.g. by using **MxViewer**).

- **Arming control in Slave mode**

The *Slave Mode* is a special feature of the arming control when using a Master camera. When using this option, **all arming settings will be set automatically** to *From Master* (**General Event Settings, Recording, Actions, Messaging and Messaging 2**).

- **Arming using custom signals**

In this case, the arming status of a MOBOTIX camera is controlled using the **Custom Signals CS1** and **CS2** as well as the **Logically Combined Signal (CSL)** of a Master camera. Activating the signals **CS1** and **CS2** will show further parameters, which allow setting the conditions for arming the camera. Arming can thus be controlled using the camera's signal input, a time table profile and the status of the Master camera's signal input.

#### Note

Note that you can call the camera from a touch-tone phone to change the MOBOTIX camera's arming status. For additional information on this topic, see section 9.6, *Remotely Controlling the Camera Using a Phone*.

The **CS2** signal can have different settings than **CS1**, allowing you to create a second signal, which is totally independent of **CS1**.

The **Logically Combined Signal (CSL)** can be used to combine the settings from **CS1** and **CS2**. For example, you can use this signal to control the camera's arming according to one of **its time table profiles** and the **signal input of a different MOBOTIX camera**.

#### Example 1: Camera network with Master/Slave arming

- **Requirement:**

In order to control the camera's arming, the signal input of one MOBOTIX camera at a central location (e.g. reception) has been connected to the key switch of the alarm system.

The arming status of all other MOBOTIX cameras (Slave cameras) is supposed to be controlled from this Master camera. When activating the alarm system, all arming functions of the Slave cameras are supposed to be activated as well.

#### Example:

The **Arming status** of the **Slave** cameras is controlled completely by the **Master** camera

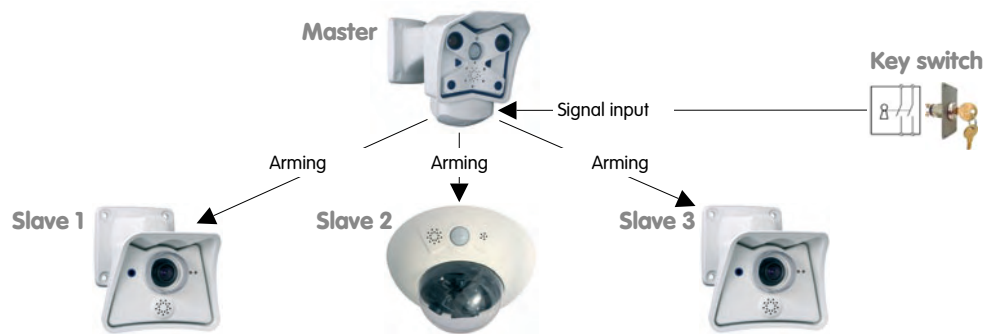

- **Configuring the Master camera:**

**Setup Menu > General Event Settings**

- Enable the **Master/Slave** parameter.
- Set the camera's **Arming** to *SI Open (high)* or *SI Closed (low)* as required by the activated alarm system.
- Activate the **Arming** parameter in each of the **Recording, Actions, Messages** and **Messages 2** dialogs, as needed.

Click on the **Set** button, then on **Close** and permanently save the settings of the Master camera.

- **Configuring the Slave cameras:**

**Setup Menu > General Event Settings**

- Set **Arming** to *Slave Mode*.
- Enable the **Master/Slave** parameter.
- Enter the IP address of the **Master camera**.

Click on the **Set** button, then on **Close** and permanently save the settings of the Slave camera.

**Note**

**All arming settings of the Slave cameras will be set automatically to From Master (General Event Settings, Recording, Actions, Messaging and Messaging 2).**

**Example 2: Camera network with one key switch**

- **Requirement:**

The signal input of one MOBOTIX camera at a central location (e.g. reception) has been connected to the key switch of the alarm system. The main arming switch of this (Master) camera itself is not enabled.

The main arming switch, events and recording features of all other cameras have been enabled permanently. These cameras record video sequences, if the cameras detect movements in the VM windows.

In addition, the other cameras are supposed to send e-mails upon detecting a VM event, but only if the alarm system has been activated by the key

**Example:**

The **Arming status** of the e-mail message feature of the **Slave** cameras is controlled by the **signal input** of a **Master** camera

switch. Only the Master camera's signal input is connected to the alarm system.

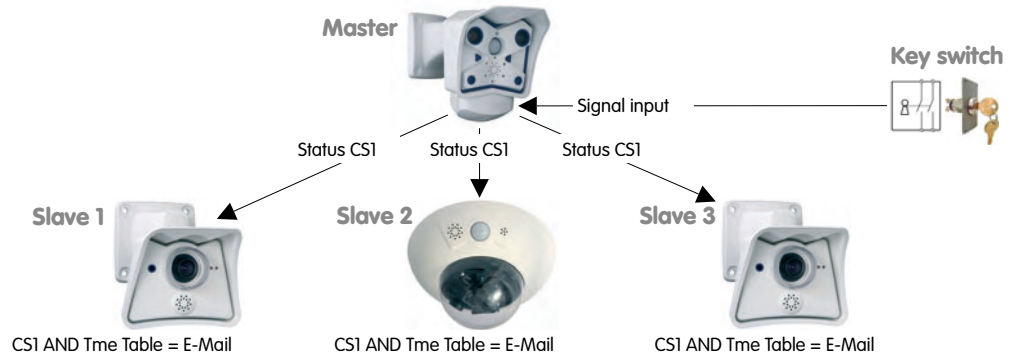

- **Configuring the Master camera:**

**Setup Menu > General Event Settings**

- **Arming** has already been set to *Off*.
- Enable the **Master/Slave** parameter.
- Set the camera's **CS1** signal to *Signal Input, Pin 9-5, SI Open (high)* (or *SI Closed (low)* as required by the activated alarm system).

Click on the **Set** button, then on **Close** and permanently save the settings of the Master camera.

- **Configuring the Slave cameras:**

**Setup Menu > General Event Settings**

- **Arming** has already been set to *Enable*.
- Set **Custom Signal 1 (CS1)** to *From Master*.
- Enable the **Master/Slave** parameter.
- Enter the IP address of the **Master camera**.

**Setup Menu > Messaging**

- Set **Message Profile** to *CS1*.
- Select a **Time Table Profile**.
- Select an **E-Mail Action**.

Click on the **Set** button, then on **Close** and permanently save the settings of the Slave camera.

**Note**

These settings will synchronize the status of the message profile of the Slave cameras with the **CS1** signal of the Master camera (remote signaling). Hence, the **message profile** of the Slave cameras is always active, if the **signal input of the Master camera** detects the selected signal and the specified **time table** of the Slave camera is active.

## 7.6 Events

### 7.6.1 Event Selection

The **Setup Menu > Event Settings** dialog allows activating and configuring the events that are detected by the camera. Use the **More** button to show all available events. Most of the events have additional fields that are only displayed if the corresponding event has been activated. The MOBOTIX camera can detect and react to the **following events**:

Kameramodell	
X	-
X	-
-	X
-	X

#### User Events

- **UC: User Click**
- **BT: Camera key (Button)**
- **IR: IR remote control**

#### Video Motion Events

- **VM, VM2: Video Motion window**

#### Hardware Sensor Events

- **PI: PIR sensor (Passive-Infrared sensor)**
- **MI: Microphone**
- **IL: Illumination**
- **TP: Temperature**

#### Signal and Exposure Events

- **SI: Signal Input**
- **SIx: Additional signal input lines (SI2, SI3, SI4)**
- **RC: IP Receive (IP messages)**
- **CI: RS232 messages (COM In)**

#### Time-Related Events

- **PE: Periodic Event**
- **TT: Time Task event**
- **RD: Random event**

#### Recording Events

- **RB: Recording Begin**
- **RE: Recording End**
- **RT: Recording Terminate**
- **RH: Recording History**

#### Enhanced Events

- **EC: Event filter, Event Counter (section 7.6.3)**
- **EL: Event Logic (section 7.6.4)**





Activate the event to show the corresponding parameters

General Settings	Value	Explanation
Event Dead Time	5	<b>Event Dead Time:</b> Event timeout [0..3600 s] while detection is suspended.
<b>Events</b>		
Passive Infrared Detector (PI)	<input checked="" type="checkbox"/> 50	<b>PIR Enable:</b> Motion detected by the infrared sensor.  <b>PIR Level:</b> Triggerlevel [0..100]
Video Motion Window (VM)	<input checked="" type="checkbox"/> 0, 540, 380, 200, 200, 20, 25	<b>Video Motion Enable:</b> Motion detection using digital image analysis.  <b>Video Motion Definitions (VM):</b> lens, x, y, width, height, sensitivity (0..99%), area (0..99%), max. area (0..99%) Origin: lower left corner Lens: 0=right, 1=left <a href="#">Add Rectangle</a>
	<input checked="" type="checkbox"/> Copy Video Motion Definitions	<b>Copy Video Motion Definitions:</b> Uses the video motion definitions for both lenses.
	<input checked="" type="checkbox"/> Dual Lens Video Motion	<b>Dual Lens Video Motion:</b> Detects Video Motion events on both lenses. May reduce the frame rate.
Microphone (MI)	<input type="checkbox"/>	<b>Microphone Enable:</b> Noise detection using the internal microphone.
Signal Input (SI)	<input type="checkbox"/>	<b>Signal Input:</b> This event is triggered by an external signal (pin 9-5). Select <i>Closed/NoA</i> to trigger when loop connected to Signal Input is closed or <i>Open/Right</i> , when loop is opened.
Periodic Event (PE)	<input type="checkbox"/>	<b>Periodic Event Enable:</b> Trigger an action periodically every x seconds.
User Click (UC)	<input checked="" type="checkbox"/>	<b>User Click:</b> Triggers an event if the corresponding button on the camera's web site is clicked. <a href="#">Click here to trigger a User Click.</a>

Use variables to display information on the status of a specific event or the current value of a sensor in the camera's live image (**Setup Menu > Text and Display Settings**). For more information on this topic, see section 5.5.4 *Placeholders and Variables in the Comment Field*, the camera help and the reference manual.

**User Events:**

- **User Click (UC):** Clicking on the **UC Event** softbutton on the Live screen will manually trigger an event. Use this button for testing actions and messages as well as the video and audio recording features of the camera, for example.
- **Camera Buttons (BT):** Pressing one or both of the keys labeled **R** and **L** on the camera's front or back (depends on the model) can manually trigger events. You set up the camera to trigger an event if only the *Right* button, only the *Left* button, one of the buttons (*Right OR Left*) or both buttons (*Right AND Left*) are being pressed.
- **IR Remote Control (IR):** The camera can trigger an event when it receives a signal from an IR remote control. The camera will react to *any code* of the remote control, i.e. pressing one of the keys on any IR remote control will trigger an event.

UC Event



**Video Motion Events:**

- **Video Motion Window (VM):** The video motion sensor reacts to movements in freely definable image areas, called **video motion windows**. By default, the video motion windows are shown as dotted frames in the Live screen.

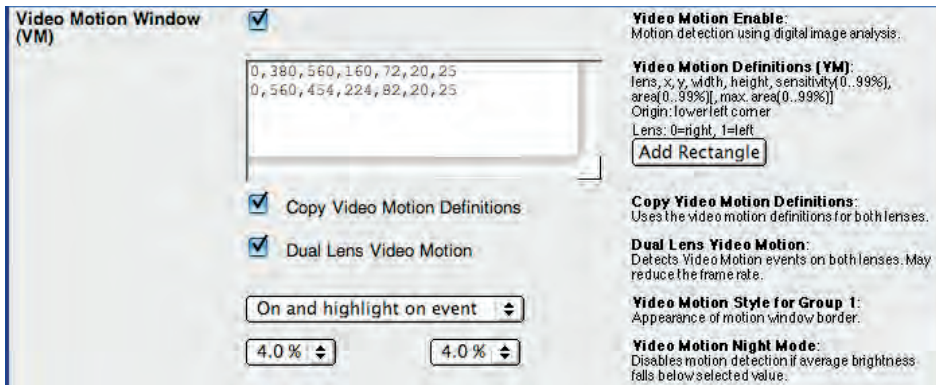

You can define several independent video motion windows for each image sensor (camera lens). The other parameters of this event allow setting the conditions for triggering an event if the camera software detects movements. For example, the percentage value controls how many of the video motion window's pixels have to change before the camera triggers an event. For additional information on this topic, see section 7.6.2, *Video Motion Detection*.

**Hint:** Using the **\$(SEN.VIM)** variable will display the number of the video motion window that has triggered an alarm in the camera's event image.

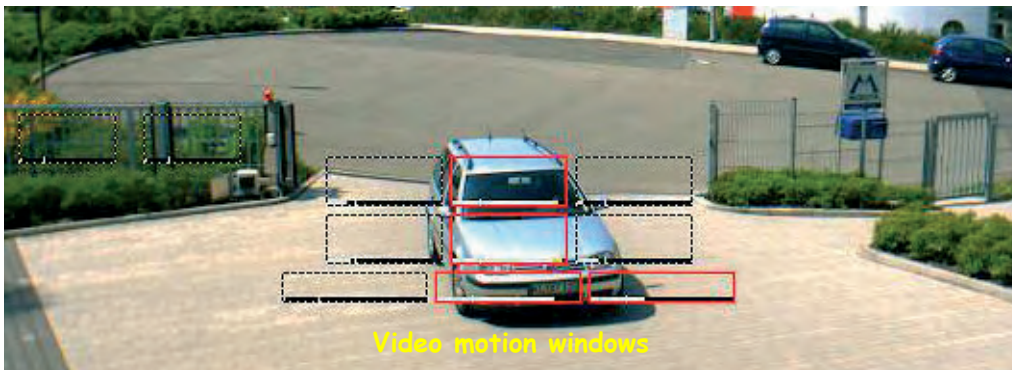

Rather set several small Video Motion windows than one large window

**Caution**

MOBOTIX **Dual camera models** will also evaluate the video motion windows of the sensor (*Right, Left*) that is currently *not* shown on the Live screen.

In contrast, MOBOTIX **Night models** (with factory defaults) will only evaluate the video motion windows of the currently active image sensor (*Right, Left, or Auto*). Activate the **Dual Lens Video Motion** option if you would like to evaluate the video motion windows on both image sensors on Night models.

Field of view of the PIR sensor: +/-15°, range: about 10 m

To trigger an alarm if the camera detects noises:  
**MI**

The trigger value of the Illumination (IL) event can switch lamps on or off, for example

### Hardware Sensor Events:

- **Passive Infrared Sensor (PI):** The passive infrared sensor registers moving objects within the sensor area (e.g. persons, animals) that radiate heat. You can set the sensitivity of the sensor by entering a **PIR Level** between 10 (high) to 100 (low). The PIR sensor reaches about 10 meters (34 ft.) and has a field of view of  $\pm 15^\circ$ . Note that the PIR sensor reacts to **moving heat sources** and is invaluable for detecting movements within its detection range even in complete darkness.

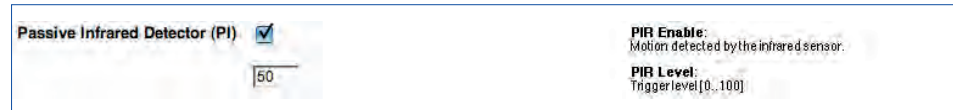

**Hint:** Use the **\$(SEN.PIR)** variable to show the current value of the PIR sensor in the live image of the camera (values range from 0 to 100). In addition, the camera can display the current level and the trigger value as bar or scroll chart in the lower part of the camera image (**Setup Menu > Text and Display Settings > Display Options**).

- **Microphone (MI):** The camera's integrated microphone can react to noises in the camera's vicinity. The camera will trigger an event depending on the selected **Microphone Level** and the **Microphone Signal Width** (minimum duration) of the detected sounds. If the noise exceeds the trigger level, the camera triggers an event provided the noise lasts longer than the minimum duration specified.

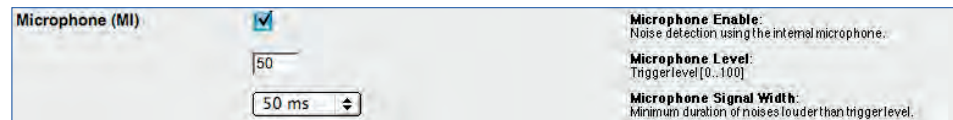

**Hint:** Use the **\$(SEN.MIC)** variable to show the current value of the microphone in the live image of the camera (values range from 0 to 100). In addition, the camera can display the current level and the trigger value as bar or scroll chart in the lower part of the camera image (**Setup Menu > Text and Display Settings > Display Options**).

- **Illumination (IL):** The camera can trigger an event if the **Illumination Level** set for the selected image sensor is higher or lower than the value entered here. Furthermore, you can use the **Illumination Action** parameter to specify if an event should be triggered once (*First*) or **every time** (*Every*) the defined trigger condition is true.

This feature can be used to switch on additional lamps at dusk or infrared lamps at night, for example.

**Hint:** Use the **\$(SEN.ILR)** variable to show the current value of the image sensor in the live image of the camera (values range from 0 to 1000). In addition, the camera can display the current illumination value and the trigger value as bar or scroll chart in the lower part of the camera image (**Setup Menu > Text and Display Settings > Display Options**).



<b>Illumination (IL)</b> <input checked="" type="checkbox"/>	<input type="checkbox"/> Right <input checked="" type="checkbox"/> Higher than <input type="checkbox"/> Lower than  <input type="checkbox"/> First	<b>Illumination Enable:</b> Triggers an event if the illumination is higher/lower than the illumination value set below.
		<b>Illumination Source:</b> Select the camera sensor for illumination.
		<b>Illumination Compare:</b> Select the trigger condition.
		<b>Illumination Level:</b> Enter the illumination in lux. Precision is one decimal digit.
		<b>Illumination Action:</b> Start action(s). <i>First:</i> trigger only first time the condition is true. <i>Every:</i> trigger everytime the condition is true.

- Temperature (TP):** The integrated temperature sensor of the camera can trigger an event if the **Temperature Level** is higher or lower than the trigger value (degrees Centigrade or Fahrenheit) entered here. Furthermore, you can specify if an event should be triggered once (*First*) or **every time** (*Every*) the defined trigger condition is true.

Monitoring internal camera temperature

<b>Temperature (TP)</b> <input checked="" type="checkbox"/>	<input type="checkbox"/> Internal Sensor <input checked="" type="checkbox"/> Higher than <input type="checkbox"/> Lower than  <input type="checkbox"/> °C <input type="checkbox"/> First	<b>Temperature Enable:</b> Triggers an event if the temperature is higher/lower than the temperature value set below.
		<b>Temperature Sensor:</b> Select the temperature sensor.
		<b>Temperature Compare:</b> Select the trigger condition.
		<b>Temperature Level:</b> Enter the temperature. Precision is one decimal digit.
		<b>Temperature Unit:</b> Select the temperature unit.
		<b>Temperature Action:</b> Start action(s). <i>First:</i> trigger only first time the condition is true. <i>Every:</i> trigger everytime the condition is true.

This feature can be used to monitor the temperatures in server or cold storage rooms, for example.

**Hint:** Use the **\$(SEN.TIN.CELSIUS)** or **\$(SEN.TIN.FAHRENHEIT)** variable to show the current internal temperature of the camera in the camera image. In addition, the camera can display the current temperature and the trigger value as bar or scroll chart in the lower part of the camera image (**Setup Menu > Text and Display Settings > Display Options**).

Open **Admin Menu > Temperatures** to see the table of the camera's internal temperatures of the last four days.

**Note:** When connecting one of the supported weather stations to the MOBOTIX camera's RS232 interface, you can display the external temperature and other weather data from the weather station in the camera's Live image.



Comment	Model
X	-
X	-
-	X
-	X

Signal input: pin 9-5

**Signal and Exposure Events:**

- **Signal Input (SI):** The signal input of the camera can trigger an event, if a door switch has been opened (using pins 9 and 5 of the serial interface), for example. The camera can trigger events if the signal input assumes a certain state (*Closed (low)*, *Open (high)*) or with *Rising (low to high)*, *Falling (high to low)* or changing (*Change (Rising or Falling)*) flank of the signal input. To prevent the camera from switching back and forth too often, you can set the **De-Bounce Time** as required.

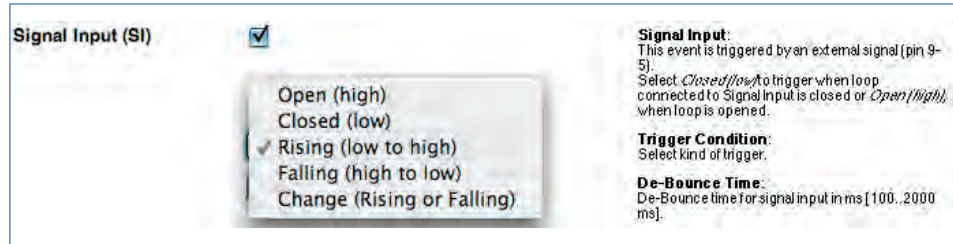

**Note**

In addition to the regular signal input, the camera provides **three signal input lines (SI2: pin 8-5, SI3: pin 6-5, SI4: pin 2-5)**. To use these additional signal input lines, make sure that **Admin Menu > Serial Interface** has been set to *Data* und *I/O Mode*.

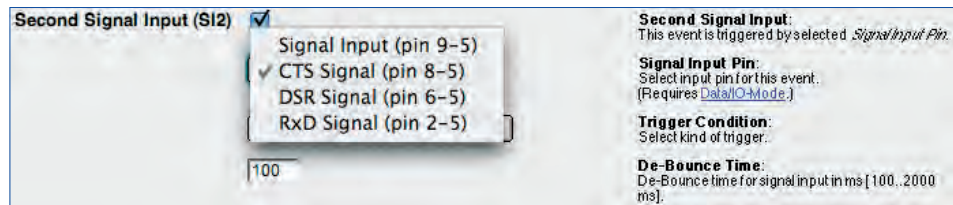

**Hint:** Use the **\$(SEN. SIN)** variable to show the current value of the image sensor in the live image of the camera (values 0 or 1).

- **IP Receive (RC):** When receiving a TCP/IP network message on a selectable port, the camera can trigger an event. The event can be triggered upon receiving any network message, only if the message contains the same string as set here, or if it matches a specific text.

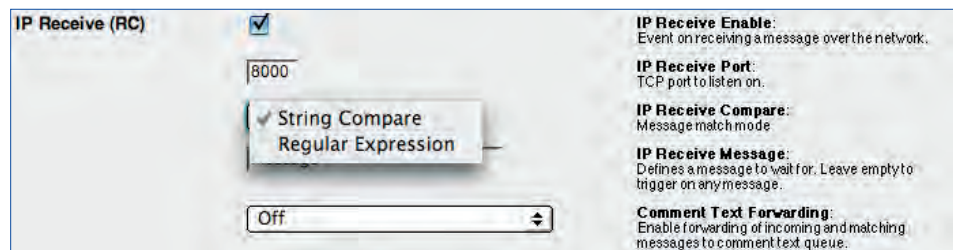

To trigger an alarm using network messages: **RC**

The *String Compare* option triggers an event if the received text is identical to the text entered here. The *Regular Expression* option triggers an event if the regular expression finds a match when compared to the received text.

For more information on regular expressions and text matching, see the camera help and the reference manual.

- **COM In (CI)**: The camera can trigger an event when it receives a message on its serial interface (RS232). The event can be triggered upon receiving any RS232 message, if the message contains the same string as set here, or if it matches a specific text.



The *String Compare* option triggers an event if the received text is identical to the text entered here. The *Regular Expression* option triggers an event if the regular expression finds a match when compared to the received text.

For more information on regular expressions and text matching, see the camera help and the reference manual.

#### Time-Related Events:

- **Periodic Event (PE)**: The periodic event can trigger events at specific intervals (milliseconds, seconds, Hz; maximum interval is 86,400 seconds = 24 hours).

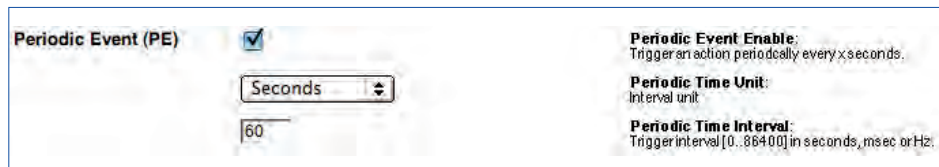

#### Note

When using the periodic event, you can set the time interval, but not the precise time when the event will be triggered. In order to create events **at specific points in time**, use the **Time Tasks** in conjunction with the Time Task (TT) event.

- **Time Task (TT)**: The Time Task event can trigger events at specific intervals and at specific points in time (minimum interval is 1 minute). Open **Setup Menu > Event Settings** and activate the **TT** event, then open **Admin Menu > Time Task** and configure a corresponding *Time Task (TT)* event.

Triggering events using the serial interface

Admin Menu >  
Time Tasks

Random switching of  
lights: RD

Recording events:  
RB, RE, RT

Time-lapse recording: His-  
tory Recording RH

Recording events will only  
be triggered if recording  
and the corresponding re-  
cording mode have been  
activated (see **Setup  
Menu > Recording**).

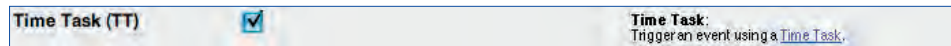

Enter the desired intervals (minutes, hours, days of month, months, and weekdays) or numeric values to set the time(s) at which the event will be triggered. Note that you can define more than one time task and that the camera runs all of them in parallel. For additional information on this topic, see section 7.9, *Time Tasks*.

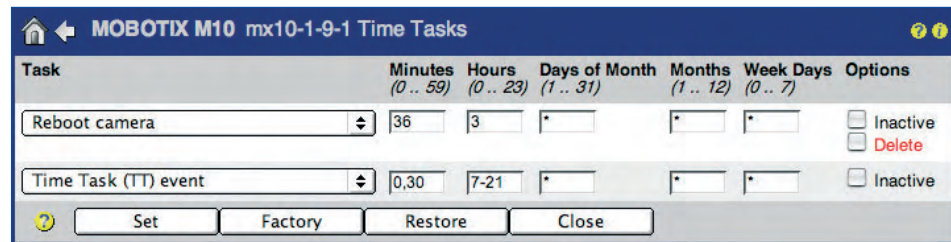

Time task events are often used to update live images from a webcam on a website using FTP transfer. This would allow updating the image on the website every 30 minutes, but only between 7 am and 9:30 pm, for example.

- **Random Event (RD)**: The random event can automatically create a certain number of events per hour. The camera will trigger an event at the time that is determined by its random algorithm.

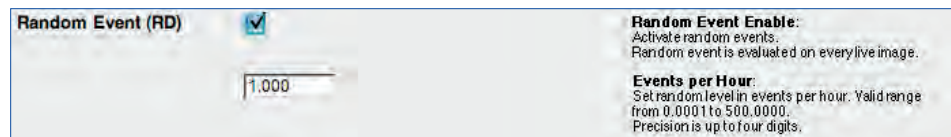

The random event could be used to randomly switch one or more lamps in a building on and off, which would very effectively simulate an inhabited building.

#### Recording events:

- **Recording Begin (RB)**: This option will trigger an event if the camera starts recording images (and sound). This event can be used to send alarm messages if the recording starts, for example.
- **Recording End (RE)**: This option will trigger an event if the camera stops recording. This event can be used to send alarm messages if the recording stops, for example.
- **Recording Terminate (RT)**: This option will trigger an event if the **Terminate Recording** function freezes image recording to protect the recorded video data, for example.
- **History Recording (RH)**: This option will trigger an event if the camera records a history image (e.g. for time-lapse video).

### 7.6.2 Video Motion Detection

The **Setup Menu > Event Settings** dialog allows setting the parameters of the MOBOTIX camera's **Video Motion** detection feature. Video motion detection is a software feature of the MOBOTIX camera, which evaluates changes in pixel brightness between two succeeding live images of the camera; this will take place **up to 30 times per second**, depending on the frame rate. The camera will use its intelligent algorithms and the values of the pertinent parameters to decide when to trigger the **VM (Video Motion)** event. This feature also allows differentiating between small and large objects and provides the means to adapt the camera software to the current surveillance task.

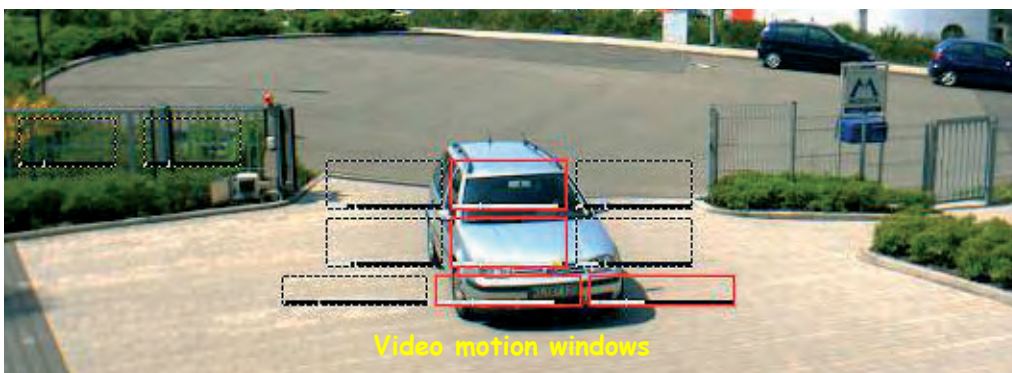

You can define one or more motion detection windows; Dual and Night models even allow setting different windows for each image sensor. Using the mouse to create the windows is usually the easiest method (see section *Creating video motion windows using the mouse* further below). If required, the default values can be adjusted in the **Video Motion Definitions (VM)** field (see section *Configuring the VM event and the video motion windows* further below).

<b>Video Motion Window (VM)</b> <input checked="" type="checkbox"/>	<b>Video Motion Enable:</b> Motion detection using digital image analysis.
<pre>0, 380, 560, 160, 72, 20, 25 0, 560, 454, 224, 82, 20, 25</pre>	<b>Video Motion Definitions (VM):</b> lens, x, y, width, height, sensitivity(0..99%), area(0..99%)[, max.area(0..99%)] Origin: lower left corner Lens: 0=right, 1=left <input type="button" value="Add Rectangle"/>
<input checked="" type="checkbox"/> Copy Video Motion Definitions	<b>Copy Video Motion Definitions:</b> Uses the video motion definitions for both lenses.
<input type="checkbox"/> Dual Lens Video Motion	<b>Dual Lens Video Motion:</b> Detects Video Motion events on both lenses. May reduce the frame rate.

#### Hint

Motion detection using the video motion (VM) event is very reliable. For best results, use **several small windows** instead of one large window. Experience shows that vertical windows are most efficient for detecting moving persons.

Video motion detection can also be used at night with the MOBOTIX Night models, when using infra-red lights, for example

VM windows can be set differently for each image sensor



**Defining video motion windows:**

Shift-click, then click in live image

**Creating video motion windows using the mouse**

- Shift-click with your mouse into the live image. A little yellow square [OBJEKT] appears where you clicked. This is the first corner of the new video motion window.
- Now click again with your mouse into the live image (do not keep the Shift key pressed). This is the second corner of the new video motion window. The camera displays the new window with a yellow frame in the live image. You can repeat the procedure (Shift-click, then click) until you have positioned the yellow frame at the desired position.
- In **Setup Menu > Event Settings**, click on the **Add Rectangle** button within 60 seconds to add a new line with the new video motion window's definition to the list of defined windows in the **Video Motion Windows (VM)** field.
- Store the entire configuration permanently by clicking on the **Set** button (the page refreshes), then on the **Close** button.

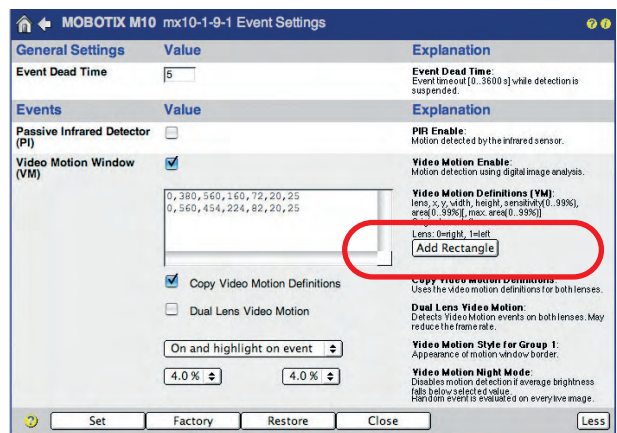

**Changing the video motion windows' appearance**

By factory default, the video motion windows are shown as dotted frames in the Live screen. If the camera detects movement, the frame of the triggering VM window will turn bright red (factory default).

VM Function: **On and highlight on event**

Video motion windows with level meter and trigger for *area* parameter

The white bar at the lower border of the window shows the current percentage of pixels that have been identified as having changed (*level*). The small vertical line shows the *trigger value* for the *Area* parameter. For additional information on this topic, see the following section.

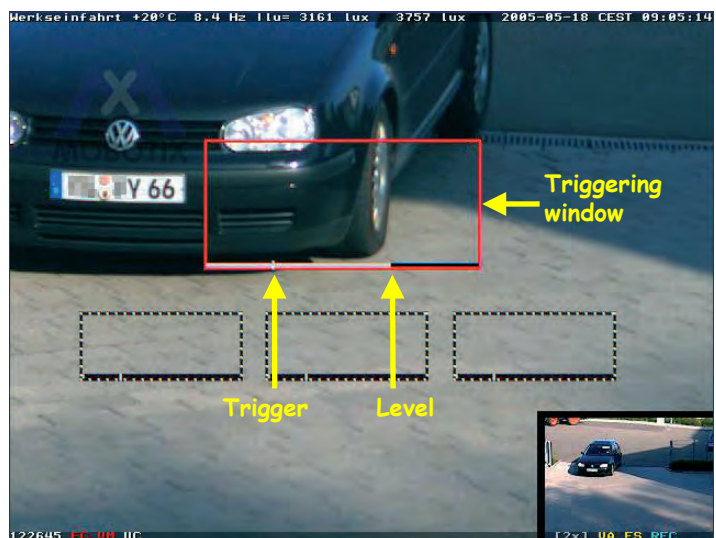

### Configuring the VM event and the video motion windows

In order to fine-tune the VM event and the video motion windows, the following parameters are available:

- **Video Motion Style:** This parameter determines how the video motion windows are displayed in the camera image:
  - **On and highlight on event:** If the camera detects movements, the frame of the triggering VM window will turn bright red. Otherwise, the video motion windows are shown as dotted frames. This is the factory default setting.  
Use this setting if the video motion windows should always be seen on all camera images.
  - **Hide but highlight on event:** If the camera detects movement, the frame of the triggering VM window will turn bright red; if nothing is detected, neither the window nor the dotted frame are visible.  
Use this setting if you would like a "clean" camera image without any distracting elements, but if you would like to see which video motion window has detected movements.
  - **On and hide on event:** If the camera detects movements, the camera software will hide the frame of the triggering VM window; neither the window nor the dotted frame are visible in the event image. Otherwise, the video motion windows are shown as dotted frames.  
Use this setting if you would like a "clean" camera image without any distracting elements, which could otherwise hide important information from view.
  - **Off:** The frame is never displayed in the camera images.  
Use this setting if you do not wish to get information where the camera software has detected movements.
- **Copy Video Motion Definitions:** This option will use the same video motion windows defined for the right image sensor on the left image sensor of the camera. This option allows using the same settings for the day and night image sensors without having to define a separate set of video motion windows for the night image sensor. Note that you should only define video motion windows for the right image sensor (*Image Sensor* parameter, see below) if you are using this option.  
This option should only be activated for MOBOTIX Dual or Night models with identical focal lengths for both image sensors, e.g. a MOBOTIX M12 with D43N43 lenses.
- **Dual Lens Video Motion:** MOBOTIX Dual camera models can evaluate the video motion windows of both image sensors, i.e. also on a sensor that is currently not shown on the camera's Live screen. In contrast, MOBOTIX Night models will only evaluate the video motion windows of the currently active image sensor (*Right* or *Left*). Use this option if you would like to evaluate the video motion windows on both image sensors on Night models.

Changing the video motion windows' appearance

Using *one* video motion window definition for both image sensors

You can set different video motion windows on the two image sensors

Deactivating the video motion window when illumination is too low

Video motion window parameters

Changing the sensitivity of a video motion window

**Note:** Using video motion detection on both image sensors may reduce the maximum frame rate.

- **Video Motion Night Mode:** When illumination falls below a certain level, the camera's image sensor amplifies the remaining light, which in turn produces image (dark) noise. This noise produces unforeseeable changes in pixel brightness and results in malfunctioning video motion detection. Use this parameter to automatically deactivate video motion detection if the illumination falls below a certain level.

**Caution:** Use this parameter with due care. Video motion detection will be *deactivated* completely if illumination is too low. Set this parameter to *Off* if you would like to prevent this from happening.

- **Video motion window parameters:** The individual parameters of the video motion windows allow adapting the windows to differing task requirements.

#### Example

**Example coordinates: 0,358,456,384,110,20,25**

**image sensor** (0 = right, 1 = left), **pos. x**, **pos. y**, **width**, **height**, **sensitivity** (0..99%), **area** (0..99%)[, **max. area** (0..99%)]

The **Video Motion Definitions (VM)** field contains the corresponding definitions. Copying the contents of this field to other MOBOTIX cameras is an easy way of transferring these definitions to other cameras.

- **Image Sensor:** This parameter determines the image sensor on which this VM window is to be used (0 = right camera sensor, 1 = left camera sensor).
- **x, y:** These parameters determine the distance of the VM window from the left and the bottom border of the camera image.
- **Width, Height:** These parameters set the width and the height of the VM window.
- **Sensitivity:** This parameter controls how much the brightness of every pixel in the VM window can change before the software considers it a "changed pixel". The smaller the value, the higher the sensitivity, as smaller changes in brightness will include the pixel in the count. If this parameter has a very small value (e.g. 2), even the smallest of change in a video motion window will prompt an event, which in turn may lead to a higher rate of false alarms.

**Note:** Change this parameter only if you have set the size of the video motion window and the *area* parameter accordingly.

- **Area:** This parameter controls *how many pixels* in the VM window need to change before the software triggers a VM event. The smaller the value, the higher the sensitivity, as fewer changing pixels will trigger an event. The trigger value set by this parameter is displayed as a vertical white line.

If this parameter has a very small value (e.g. 2), even the smallest of change in a video motion window will prompt an event, which in turn may lead to a higher rate of false alarms.

**Note:** Change this parameter only if you have already set the size of the video motion window. Changing the size of the video motion window usually requires changing the *area* parameter as well.

- **Max. area:** This parameter sets the percentage value of the *maximum number of pixels*, which may change in the VM window. If this value is exceeded, the camera will *not* trigger an event. This parameter is optional and will not be added when creating a new video motion window. The trigger value set by this parameter is also displayed as a vertical white line, provided the value is higher than the *area* value.

**Caution:** A low value will prevent event detection if the camera software detects a large number of changing pixels in the video motion window.

Use this parameter to identify smaller objects (e.g. pedestrians) while ignoring larger objects (e.g. trucks).

**Note:** Change this parameter only if you have already set the size of the video motion window. Changing the size of the video motion window usually requires changing the *max. area* parameter as well. Make sure that this parameter **always has a higher value** than the *area* parameter.

Percentage of the pixels in the video motion window that needs to change in order to trigger an event

If this value is exceeded, the camera will **not** trigger an event!

#### Hint

Entering the hash sign (#) allows adding comments in the **Video Motion Definitions (VM)** field:

**# VM window top left**  
**0,358,456,384,110,20,25**

Likewise, you can also use the hash sign to temporarily deactivate a window definition:

**# VM window top left, deactivated**  
**# 0,358,456,384,110,20,25**

Entering comments

Temporarily deactivating video motion windows



Reference windows help  
avoid **false alarms**

### Video Motion Reference windows

A video motion window can trigger unwanted events that have not been caused by moving objects, but by changes in image brightness. These changes may occur when switching lights on or off, or when moving clouds and sunny sky lead to rapid changes in illumination. A **reference window** can prevent these unwanted video motion events from occurring.

Reference windows represent a special type of video motion window. Much like video motion windows, reference windows recognize changes in pixel brightness, but they will not trigger an event, they prevent events from being triggered. **For example, if a video motion window and a reference window simultaneously detect changes in pixel brightness, the camera will not trigger an event and the camera will neither send alarm messages nor start image recording!**

Reference windows are defined just like video motion windows; adding an exclamation mark (!) at the beginning of the line in the **Video Motion Definitions (VM)** field will make this definition a reference window:

```
# Example reference window  
!0,358,456,10,40,20,25
```

Reference windows are shown in the camera images as yellow dotted frames.

### The following procedure has proven to produce the best results:

- 1) Define **video motion windows** as required and adjust the parameters accordingly (*area, max. area, etc.*).
- 2) Create a small **reference window** (e.g. 25 x 25 pixels) within an area with solid colors (wall of a building, wallpaper, asphalt, etc.) that changes brightness if the light is switched on or the clouds are moving (i.e. if illumination is changing). Make sure that you are not using an area that could be changing due to moving objects.

Make sure that the *area, max. area* and *sensitivity* parameters are set to the factory defaults.

- 3) Create a small **video motion window** with exactly the same dimensions and the same position as the reference window. To do this, simply copy the complete line of the reference window definition, add it beneath the reference window definition in the **Video Motion Definitions (VM)** text field and remove the exclamation mark.

Make sure that the *area, max. area* and *sensitivity* parameters are set to the factory defaults.

If the light is switched on, the brightness changes both within the reference window and the identical video motion window. Subsequently, the reference window will prevent the camera from triggering the VM event.

## Second set of video motion windows (VM2)

From software version 2.2.2, the camera **allows defining a second set of video motion windows (VM2)**. This feature allows carrying out different actions or messages for different video motion windows, for example.

For example, you could cover the three entrance doors of a building by defining three separate video motion windows in the **VM** set. In case of an alarm, the MOBOTIX camera would automatically call the alarm center. In addition, the **VM2** set would cover the windows of the building by a different set of video motion windows. In case of an alarm (e.g. the lights are switched on in a room), the camera would store an event image with the timestamp, but would not alert the alarm center.

In this scenario, one MOBOTIX camera can execute the surveillance tasks, which would otherwise require two separate cameras.

VM and VM2 can be evaluated as separate events or they can be combined in **Setup Menu > Event Logic**

The screenshot displays two configuration panels for Video Motion Windows. The top panel, labeled 'Video Motion Window (VM)', has a red circle around its title and a checked checkbox. It shows a video frame with a red rectangle overlaid. The coordinates for the rectangle are: 0, 380, 560, 160, 72, 20, 25 and 0, 560, 454, 224, 82, 20, 25. Below the frame are checkboxes for 'Copy Video Motion Definitions' (checked) and 'Dual Lens Video Motion' (unchecked). A dropdown menu is set to 'On and highlight on event', and two percentage fields are both set to '4.0%'. The bottom panel, labeled 'Video Motion Window (VM2)', also has a red circle around its title and a checked checkbox. It shows a video frame with a red rectangle overlaid. The coordinates are: 0, 140, 330, 200, 300, 20, 25 and 0, 940, 330, 200, 300, 20, 25. It has the same 'Copy Video Motion Definitions' (checked) and 'Dual Lens Video Motion' (unchecked) options. The dropdown menu is set to 'Hide but highlight on event', and the percentage fields are set to '4.0%' and 'Off'. Both panels have an 'Add Rectangle' button highlighted with a red box.

### Hint

In conjunction with the **event logic** settings (see section 7.6.4, *Event Logic (EL)*) and the **VM** and **VM2** events, you can detect a **direction of movement** (e.g. "only create an alarm if VM window 1 detects a movement and VM window 2 detects a movement within 2 seconds of VM 1"). Such a setup could be used to store the images of vehicles that are exiting the compound, while ignoring those that are entering.

Evaluating direction of movement: VM + VM2 + EL

### 7.6.3 Event Filter (EC Event)

The **Event Counter (Setup Menu > Event Filter (Event Counter))** is an event filter that prevents the camera from immediately executing an action or sending a message; it will only do so if a certain number of the selected events occur within the specified timeframe.

The Event Counter helps monitor production processes

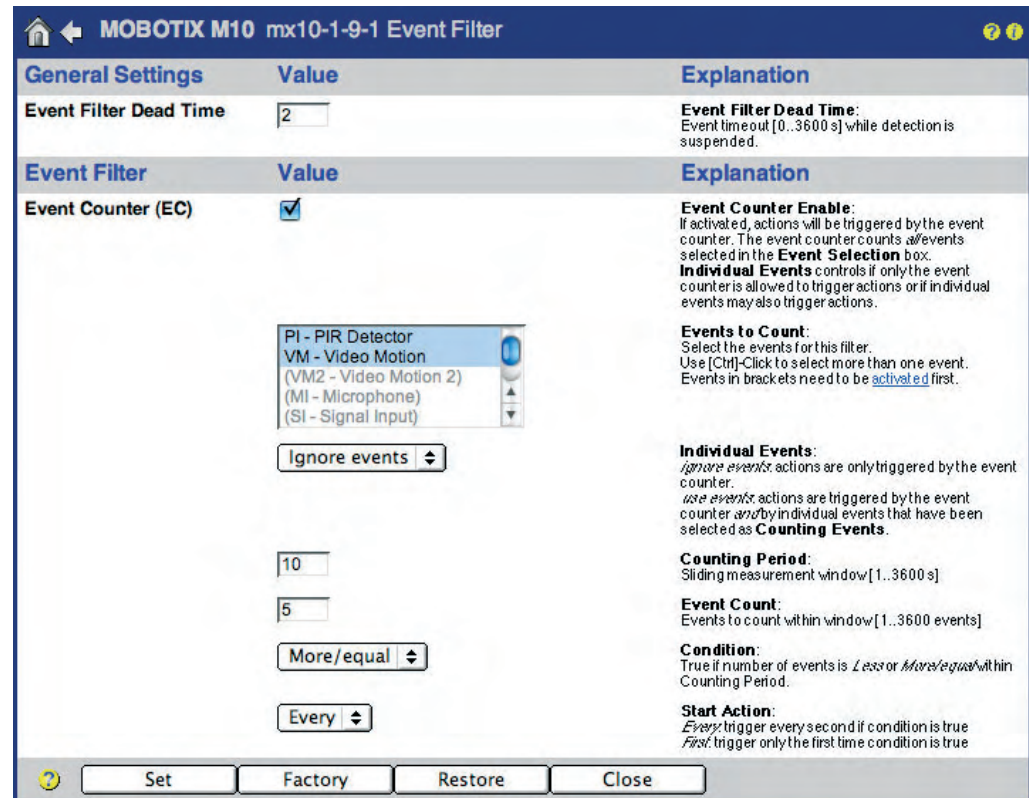

The event filter can be used, for example, to monitor a conveyor belt in a production scenario. If the MOBOTIX camera counts fewer objects per minute than required, the camera will trigger the alarm.

- **Event Counter Enable:** If activated, the camera can trigger EC (Event Counter) events. The event counter counts all events selected in the **Events to Count** list.
- **Events to Count:** The event counter counts the events highlighted in this list. Make sure that the highlighted events have been activated in the **Setup Menu > Event Settings** dialog if you intend to use them. If an event is displayed gray and in parentheses, it has not been activated.
- **Individual Events:** This parameter allows using the selected events for triggering actions and messages although they do not occur frequently enough to trigger the EC event of the event filter. The *Ignore events* setting will suppress actions and messages from single (isolated) events; *Use events* will allow actions and messages from isolated events.

- **Counting Period:** Sets the timeframe within which the events are counted before the camera triggers an EC event (maximum value is 3600 seconds = 60 minutes).
- **Event Count:** Sets the number of events that are counted within the timeframe specified above for triggering an EC event.
- **Condition:** Select the condition for triggering an EC event. The *More/equal* option will trigger an EC event if the number of events is equal to or higher than the specified number of events within the specified timeframe. The *Less* option will trigger an EC event if the number of events is lower than the specified number of events within the specified timeframe.
- **Start Action:** This option determines how often the EC event will be triggered. The *First* option will trigger the event only once, i.e. when the camera first detects that the condition has been met. The *Every* option will trigger the event repeatedly (about once every second) **as long as** the condition is true.

Using the scenario of the conveyor belt introduced previously, the *Every* option would trigger one alarm per second while the belt is standing still; the *First* option would only trigger once, when the belt stops moving. The next alarm would only follow if the conveyor belt would resume normal operation and then stop again.

### 7.6.4 Event Logic (EL Event)

The event logic feature (available from software version 2.2.2) provides a method of triggering events only if two other events occur within the specified timeframe. Moreover, you can also set an event order, if required.

This dialog allows configuring two independent event logic events (EL and EL2). Similar to the event filter, this feature creates events (EL and EL2), which are then used to trigger actions and messages.

The camera will trigger an EL event if it detects an event from **Event Set B** within the time span set in **Maximum Time Window** after an event from **Event Set A** has occurred, but only if the **Minimum Delay** has passed between the events from both event sets.

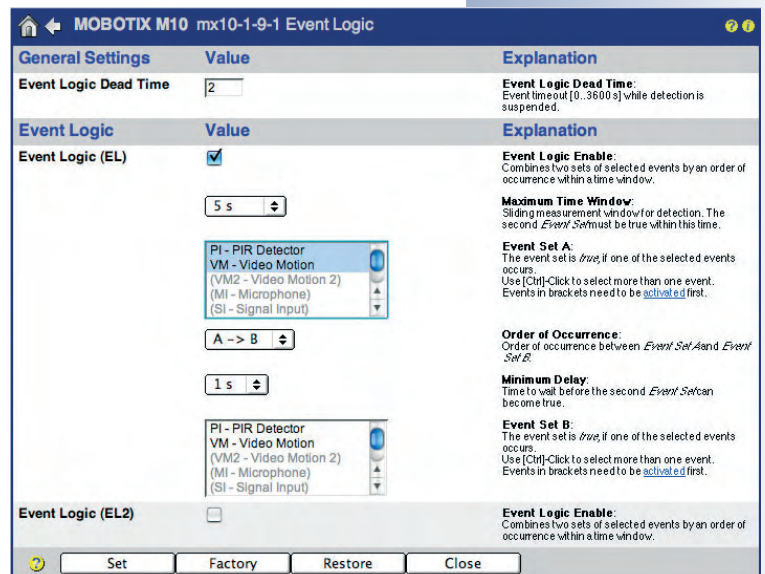



Logical linking of several events

If **Order of Occurrence** has been set to  $A \rightarrow B$ , the event from Event Set A has to occur before the event from Event Set B. Selecting the  $A \leftrightarrow B$  option means that the order of occurrence is irrelevant.

- **Event Logic (EL)**: If activated, the camera can trigger EL events. The event logic evaluates all events selected in the **Event Set A** and **Event Set B** lists.
- **Maximum Time Window**: Sets the time span within which the events from the two event sets have to occur before the camera triggers an EL event (1 second to 15 minutes).
- **Event Set A**: Select the events, which have to occur first in order to trigger an EL event. Make sure that the highlighted events have been activated in the **Setup Menu > Event Settings** dialog if you intend to use them. If an event is displayed gray and in parentheses, it has not been activated.
- **Order of Occurrence**: Set the order in which the events from the two event sets have to occur in order to trigger an EL event. If the  $A \rightarrow B$  option has been selected, an event from Event Set A has to occur before an event from Event Set B. If the  $A \leftrightarrow B$  option has been selected, the order in which the events from the two event sets occur is irrelevant.
- **Minimum Delay**: Sets the minimum time span between an event from one event set and an event from the other event set that has to pass before the camera triggers an EL event (0 to 20 seconds).
- **Event Set B**: Select the events, which have to occur before or after the ones selected in Event Set A in order to trigger an EL event. Make sure that the highlighted events have been activated in the **Setup Menu > Event Settings** dialog if you intend to use them. If an event is displayed gray and in parentheses, it has not been activated.

## 7.7 Actions and Messaging, Action and Messaging Profiles

Use the **Setup Menu > Actions**, **Setup Menu > Messaging** and **Setup Menu > Messaging 2** dialog to set the desired actions and messages, which the MOBOTIX camera will carry out if it detects an activated event.

General Settings	Value	Explanation
<b>Action Profile</b>	Enable	<b>Enable Action Profile:</b> Controls this action profile: <ul style="list-style-type: none"> <li>☑: activate the profile.</li> <li>☒: deactivate the profile.</li> <li>☒: Actions armed by signal input.</li> <li>☑: Actions armed by custom signal as defined in <a href="#">General Event Settings</a>.</li> <li>From Master: copies Actions arming state from master camera.</li> </ul>
	Weekdays_Mo-Fr	<b>Time Table Profile:</b> Time table for this action profile. ( <a href="#">Time Tables</a> )
	5	<b>Action Dead Time:</b> Action timeout [0..3600 s] before a new action can take place.
	<ul style="list-style-type: none"> <li>PI - PIR Detector</li> <li>VM - Video Motion</li> <li>(VM2 - Video Motion 2)</li> <li>(MI - Microphone)</li> <li>(SI - Signal Input)</li> </ul>	<b>Event Selection:</b> Select the events which will trigger the actions below. Use [Ctrl]-Click to select more than one event. Events in brackets need to be <a href="#">activated</a> first. <a href="#">EC</a> or <a href="#">EL</a> for filtered events.
Actions	Value	Explanation
<b>Signal Out Action (SO)</b>	2 s	<b>Signal Out Action:</b> Switch signal output (pin 1-5) to high for the desired duration. Turn ☑ to enable <a href="#">Enhanced Signal Out Options</a> . Test signal out: <a href="#">switch_high</a> and <a href="#">switch_low</a>
<b>File Transfer Action (FT)</b>	FTP-Webcam	<b>FTP Profile:</b> Transfer image to remote host using file transfer protocol. ( <a href="#">FTP Profiles</a> )
<b>Visual Alarm (VA)</b>	On	<b>Activate Visual Alarm:</b> ☑ will draw image effects on event.
	Outline Frame	<b>Visual Effect:</b> Select the visual effect. <ul style="list-style-type: none"> <li><a href="#">Bars</a>: draws bars along the image borders</li> <li><a href="#">Frame</a>: draws a box around the image</li> <li><a href="#">Symbol</a>: draws a small symbol in the upper right corner of the image</li> </ul>
	Red	<b>Effect Color:</b> Choose effect color.
	10 s	<b>Display Duration:</b> Select the duration after which the effect will be removed from the image.
	Enable	<b>Alarm Acknowledge:</b> Alarm Acknowledge Allow users to acknowledge new alarms by clicking on a soft button.

The MOBOTIX camera can carry out the following **actions** and **messages**:

### Actions

- **SO**: Switches the signal output.
- **FT**: Transfers image and audio data via FTP.
- **VA**: Displays the visual alarm in the camera image.

### Messages

- **SD**: Plays back a sound or message on the camera speaker.
- **EM**: Sends an e-mail.
- **CL**: Places a phone call.
- **IP**: Sends a network message.





The **Setup Menu > Messaging 2** dialog allows defining different actions and messages for a second set of events. This approach provides a second set of messaging options.

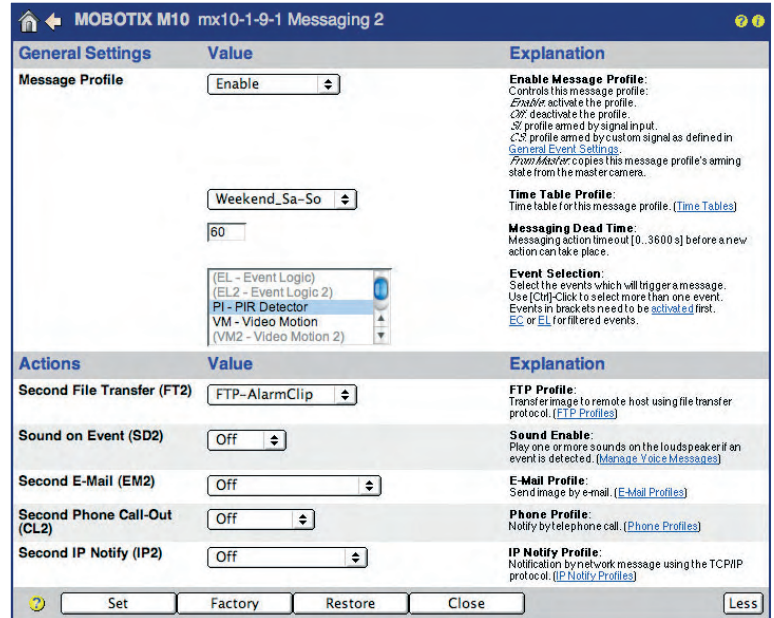
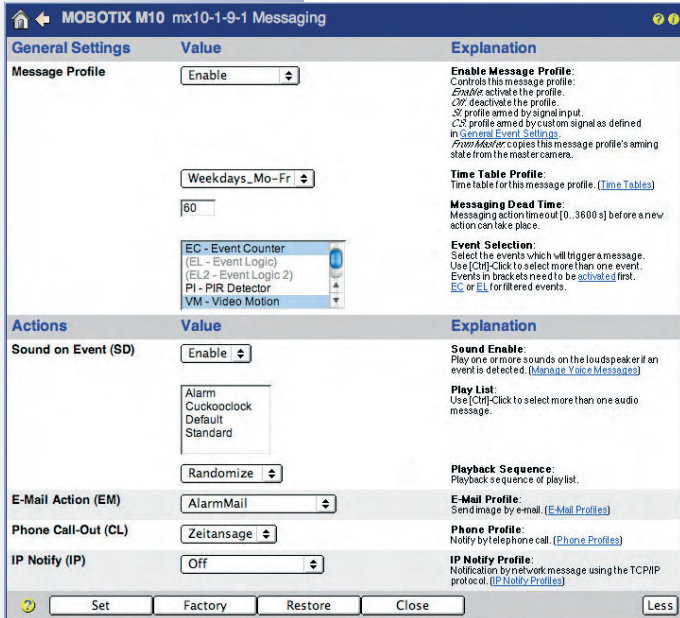

Activating action and message profiles using time tables

The camera will not carry out any actions or messages within the deadtime

The options in the **Setup Menu > Enhanced Signal Out Options** dialog provide for defining a third set of messaging options.

The action and messaging profiles (**Setup Menu > Actions, Messaging, Messaging 2**) can be activated or deactivated either manually or by using the signal input *SI Closed (low)* or *SI Open (high)* options and a key switch, for example. If an action or messaging profile is active (regardless if it has been activated manually or from the signal input), the status of the profile can also be controlled using a **Time Table** profile. In this case, the action/messaging profile is active only at the times and on the days defined in the time table. For additional information on this topic, see section 7.8.6, *Time Tables*.

Using the Action/Messaging Dead Time parameters, you can set a minimum time span between two actions/messages (0 to 3600 seconds = 60 minutes). The dead time prevents the camera from carrying out the next action or message within the specified time span. This allows the camera to record video and audio upon detecting the first event, but it will only send an alarm (e.g. a phone call) upon the first event (not every event) and then again after ten minutes, when the camera detects new events.

Select the events in the **Event Selection** list, which will prompt the camera to carry out actions and messages. Make sure that the highlighted events are activated in the **Setup Menu > Event Settings** dialog if you intend to use them. If an event is displayed gray and in parentheses, it has not been activated.

Once the action or messaging profile has been activated and the events have been selected, you can configure the action or message as required. Note that the camera can carry out more than one action or message simultaneously.

### Note

The symbol of the configured action or message is displayed in gray and in parentheses at the bottom of the camera image, if it has been deactivated temporarily by a time table profile or by the signal input (using a key switch, for example).

### Note

As of software version 2.1.0.5, the **recording of video and audio data is independent from the configured actions and messages**. One action or message can be triggered by one or more events; the recording of video and audio data can be triggered by the same or by other events, as required. Chapter 8, *Recording*, provides more information on configuring the recording options for video and audio data.



### 7.7.1 Signal Out (Action SO)

This action can close the signal out pins (1-5) for a specific period of time (1 second to 5 minutes).



Signal output closed: **high**

Signal output open: **low**

**Note**

The reaction of the signal output can be controlled in **Setup Menu > Enhanced Signal Out Options** (switching time, dead time, etc.). If you would like to use these features, make sure not to configure the signal output in **Setup Menu > Actions**, but in **Enhanced Signal Out Options**.

MOBOTIX M10 mx10-1-9-1 Enhanced Signal Out Options

Attribute	Value	Explanation
Signal Out Arming	Enable	<b>Activate Enhanced Signal Out:</b> <i>Enable:</i> activate Signal Out Action. <i>Off:</i> deactivate Signal Out Action. Note: make sure to set <a href="#">Signal Out Action to Off</a> . Test signal out: <a href="#">switch high</a> and <a href="#">switch low</a> .
	MyCustomTimes	<b>Time Table Profile:</b> Time table profile for time-controlled signal out. ( <a href="#">Time Tables</a> )
Signal Out Switch Time	60	<b>Switch Time:</b> Switch Signal Output (pin 1-5) to High for [0..86000] seconds.
Signal Out Dead time	10	<b>Dead Time:</b> Timeout [0..3600 s] while detection is suspended.
Display Options	<input type="checkbox"/>	<b>Show Event Symbols:</b> Show Signal Out event symbols.
<b>Illumination Filter</b>		
Illumination	Greater	<b>Illumination Filter:</b> Allow Signal Out actions, if illumination is greater/less than trigger level.
	100.0	<b>Level:</b> Enter the level for illumination in lux. Precision is one decimal digit.
<b>Events for Signal Out</b>		
Passive Infrared Detector (PI)	<input type="checkbox"/>	<b>PIR Enable:</b> Motion detected by the infrared sensor.
Video Motion Window (VM)	<input checked="" type="checkbox"/>	<b>Video Motion Enable:</b> Motion detection using digital image analysis. <b>Note:</b> parameters are taken from <a href="#">Event Settings</a> .
Microphone (MI)	<input type="checkbox"/>	<b>Microphone Enable:</b> Noise detection using the internal microphone. <b>Note:</b> parameters are taken from <a href="#">Event Settings</a> .
Signal Input (SI)	<input type="checkbox"/>	<b>Signal Input:</b> This event is triggered by an external signal (pin 9-5). Select <i>Closed/low</i> to trigger when loop connected to Signal Input is closed or <i>Open/high</i> when loop is opened.
Periodic Event (PE)	<input type="checkbox"/>	<b>Periodic Event Enable:</b> Trigger an action periodically every x seconds.
Time Task (TT)	<input type="checkbox"/>	<b>Time Task:</b> Trigger an event using a <a href="#">Time Task</a> .
User Click (UC)	<input type="checkbox"/>	<b>User Click:</b> Triggers an event if the corresponding button on the camera's web site is clicked. <a href="#">Click here to trigger a User Click</a>
Buttons (BT)	<input type="checkbox"/>	<b>Buttons Enable:</b> Trigger an event by pressing the button(s) on the front panel.
IR Remote Control (IR)	<input type="checkbox"/>	<b>Remote Control Enable:</b> Trigger an event by signals from any IR remote control. <b>Note:</b> parameters are taken from <a href="#">Event Settings</a> .
IP Receive (RC)	<input type="checkbox"/>	<b>IP Receive Enable:</b> Event on receiving a message over the network. <b>Note:</b> parameters are taken from <a href="#">Event Settings</a> .
COM In (CI)	<input type="checkbox"/>	<b>COM In Enable:</b> Triggers an event when receiving a message from the serial interface. Set interface to <a href="#">Data &gt; Terminal and Logger mode</a> . <b>Note:</b> parameters are taken from <a href="#">Event Settings</a> .
Temperature (TP)	<input type="checkbox"/>	<b>Temperature Enable:</b> Triggers an event if the temperature is higher/lower than the temperature value set below. <b>Note:</b> parameters are taken from <a href="#">Event Settings</a> .
Random Event (RD)	<input type="checkbox"/>	<b>Random Event Enable:</b> Activate random events. Random event is evaluated on every live image.

Set Factory Restore Close Less

7.7.2 File Transfer (Action FT)

This action transfers video and audio data to an FTP server. Select the name of an FTP profile you configured in **Admin Menu > FTP Profiles**.

The FTP profile contains the storage location of the FTP server; it sets the naming conventions for the files as well as other options. For additional information on configuring FTP profiles, see section 7.8.2, *FTP Profiles*.

Automated FTP file transfer

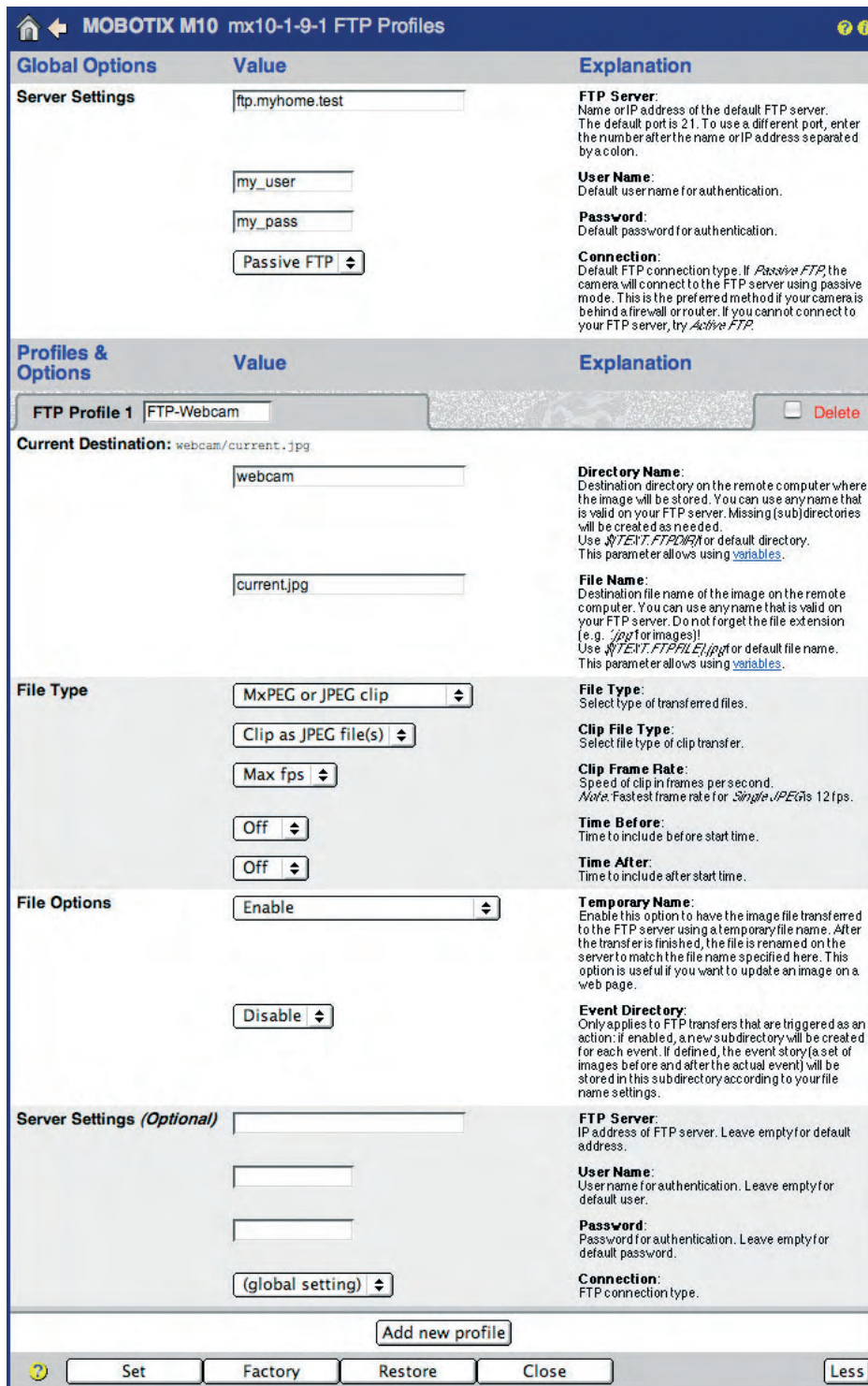

Choose from different file formats (image or clip files)

Kameramodell	X	-
CameraAction	X	-
	-	X
	-	X

### 7.7.3 Visual Alarm (Action VA)

The MOBOTIX camera can highlight the live image if an event occurs. You can define the type (**Visual Effect**), the **Color** and the **Duration** of this action. The visual effect can be set to one of the following options: *Bars Left/Right*, *Bars Top/Bottom*, *Outline Frame*, *Outline Frame Bold*, *Little Ball* and *Alarm Lamp*. Likewise, you can set the duration of the visual effect.

The visual alarm is perfectly suited to identify the camera that is triggering the alarm if several cameras are shown on one monitor (using the options *Outline Frame* and 5 s, for example).

Red frame in the live image appears only in case of an alarm



Kameramodell	X	-
CameraAction	X	-
	-	X
	-	X

Create your own voice messages and upload the .WAV files into the camera (8 bit, Mono, 8 kHz; record these files using Windows Recorder)

### 7.7.4 Sound on Event (Message SD)

This message action plays back a **sound file** on the camera's integrated speaker. The sound file may be one of the camera's system sounds or a custom sound file **you previously recorded** and stored in the camera. You may also select several sound files, which are then used randomly by the camera.

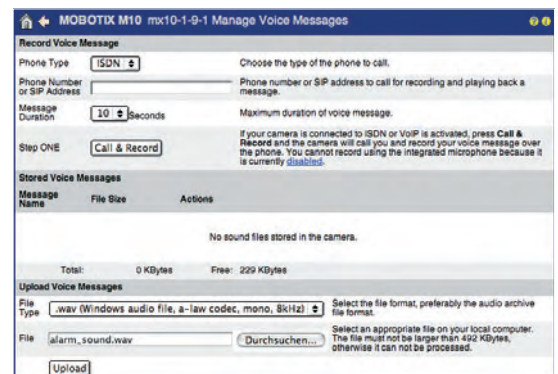



### 7.7.5 E-Mail (Message EM)

This message action can send an e-mail when triggered by an event. Select the name of an e-mail profile that you configured in **Admin Menu > E-Mail Profiles**.

The e-mail profile contains the recipient and the sender of the e-mail, the type of attachment and the text of the message itself. The attachment can be the event video (including audio), the current live images, only the image information (JPEG header) or the system messages. For additional information on configuring e-mail profiles, see section 7.8.3, *E-Mail Profiles*.

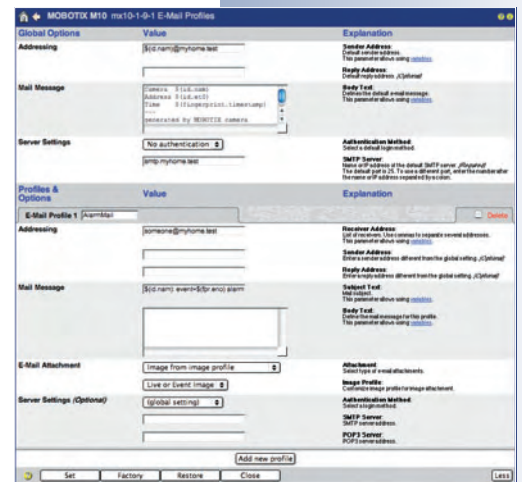

### 7.7.6 Phone Call-Out (Message CL)

This message action can place a phone call when triggered by an event. Select the name of a phone profile that you configured in **Admin Menu > Phone Profiles**.

The phone profile specifies one or more phone numbers, the connection type to use (*ISDN* or *SIP*), the audio file that is to be played back by the camera and what the camera should do after it has played back the audio file (*Hangup*, *Listen*, *Speak*, *Intercom*). If desired, you can activate the camera remote control (using the phone touchtone keys) and specify a PIN number to enter before you can hear the camera message. For additional information on this topic, see section 7.8.4, *Phone Profiles*.

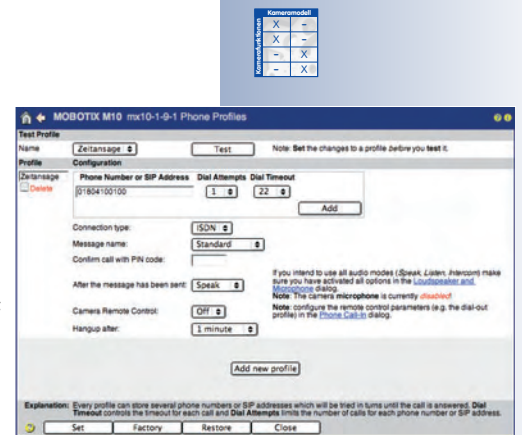

### 7.7.7 IP Notify (Message IP)

This message action can send TCP/IP network messages when triggered by an event. The recipients can be other network devices (e.g. other MOBOTIX cameras or PCs) anywhere on the LAN or the Internet. The recipient has to run a program, which can receive, acknowledge and process the network message (e.g. **MxViewer**, another MOBOTIX camera, **MX-Guard** for Windows computers; see [www.mobotix.com](http://www.mobotix.com)). Select the name of a network message profile that you configured in **Admin Menu > IP Notify Profiles**.

The network message profile contains the recipients' IP addresses (including the TCP ports), the data protocol to use and what to send. The network message can include a text message, the event video (including audio), the current live images, only the image information (JPEG header) or the system messages. For additional information on this topic, see section 7.8.5, *IP Notify Profiles*.

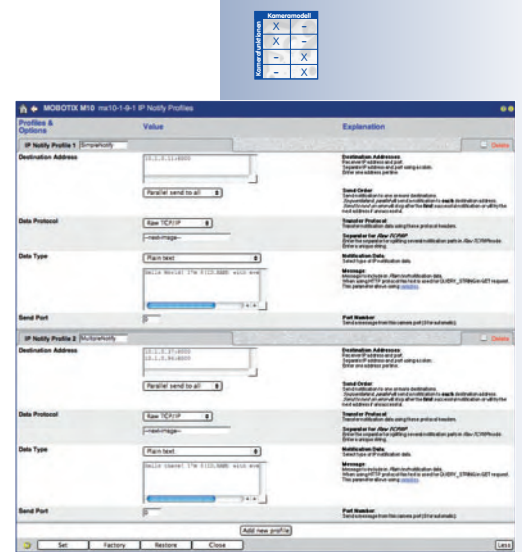



Profiles are grouping configuration parameters



Global options are used as default settings for several profiles

Define dynamic texts using variables

## 7.8 Working with Profiles

### 7.8.1 Overview

Several configuration dialogs of the MOBOTIX camera are based on **profiles**. A profile collects all configuration settings (e.g. for sending an e-mail) under one descriptive name for further use. Profiles can be created and managed independent of the intended purpose. If you would like to assign a specific message to an event or to other functions (e.g. in **Setup Menu > Messaging**), you will use one of the defined profiles.

The MOBOTIX camera currently uses the following profiles:

- **FTP Profiles:** FTP file transfers, **section 7.8.2**.
- **E-Mail Profiles:** Sending e-mails, **section 7.8.3**.
- **Phone Profiles:** Placing SIP/ISDN voice calls to other phones, **section 7.8.4**.
- **IP Notify Profiles:** Sending network messages, **section 7.8.5**.
- **Time Tables:** Controls the arming status of the camera, actions, messages, video and audio recording, activate logo profiles and hide image areas for certain periods of time and during holidays, etc., **section 7.8.6**.
- **Image Profiles:** Displaying text information in the camera image, **section 7.8.7**.
- **Logo Profiles:** Displaying logos and graphics in the camera image, **section 7.8.8**.

Some profile dialogs allow setting **global options**. These options are used as default settings in all other profiles (e.g. for authentication purposes at the SMTP server for e-mail profiles). If required, you can enter specific settings in the individual profiles, thus overriding the global setting. If the corresponding field remains empty, the camera will use the global setting. This feature avoids having to enter redundant information several times.

Some profile options use **variables** to enter dynamic texts. For example, you could automatically add the timestamp of the last event or the data received from an external device that is connected to the camera's RS232 interface. For more information on variables, see the *Using Variables* topic in the camera help and the reference manual.

7.8.2 FTP (FT) Profiles

**Admin Menu > FTP Profiles** contains all parameters that are used for transferring files to an FTP server. The **File Transfer Protocol** is commonly used by webcams to update images and other data on web servers.

**Global Options**

Value	Explanation
ftp.myhome.test	<b>FTP Server:</b> Name or IP address of the default FTP server. The default port is 21. To use a different port, enter the number after the name or IP address separated by a colon.
my_user	<b>User Name:</b> Default user name for authentication.
my_pass	<b>Password:</b> Default password for authentication.
Passive FTP	<b>Connection:</b> Default FTP connection type. If <i>Passive FTP</i> , the camera will connect to the FTP server using passive mode. This is the preferred method if your camera is behind a firewall or router. If you cannot connect to your FTP server, try <i>Active FTP</i> .

**Profiles & Options**

FTP Profile 1 | FTP-Webcam | Delete

Current Destination: webcam/current.jpg

Value	Explanation
webcam	<b>Directory Name:</b> Destination directory on the remote computer where the image will be stored. You can use any name that is valid on your FTP server. Missing (sub)directories will be created as needed. Use <i>\$(TEXT.FTPDIR)</i> or default directory. This parameter allows using <a href="#">variables</a> .
current.jpg	<b>File Name:</b> Destination file name of the image on the remote computer. You can use any name that is valid on your FTP server. Do not forget the file extension (e.g. <i>.jpg</i> for images)! Use <i>\$(TEXT.FTPFILE).jpg</i> or default file name. This parameter allows using <a href="#">variables</a> .
MxPEG or JPEG clip	<b>File Type:</b> Select type of transferred files.
Clip as JPEG file(s)	<b>Clip File Type:</b> Select file type of clip transfer.
Max fps	<b>Clip Frame Rate:</b> Speed of clip in frames per second. <i>Note:</i> Fastest frame rate for <i>Single JPEGs</i> 12 fps.
Off	<b>Time Before:</b> Time to include before start time.
Off	<b>Time After:</b> Time to include after start time.
Enable	<b>Temporary Name:</b> Enable this option to have the image file transferred to the FTP server using a temporary file name. After the transfer is finished, the file is renamed on the server to match the file name specified here. This option is useful if you want to update an image on a web page.
Disable	<b>Event Directory:</b> Only applies to FTP transfers that are triggered as an action: if enabled, a new subdirectory will be created for each event. If defined, the event story (a set of images before and after the actual event) will be stored in this subdirectory according to your file name settings.
	<b>FTP Server:</b> IP address of FTP server. Leave empty for default address.
	<b>User Name:</b> User name for authentication. Leave empty for default user.
	<b>Password:</b> Password for authentication. Leave empty for default password.
(global setting)	<b>Connection:</b> FTP connection type.

Add new profile

Set Factory Restore Close Less

Choose from different file formats (image or clip files)

### Global Options

The **Global Options** section allows setting the preferred FTP server, which can be used by the profiles below. The settings comprise the name of the FTP server, the authentication data (user name and password) and the connection type (*active* or *passive FTP*; with *passive FTP* for connections to the FTP server that are using a router).

Every **FTP Profile** displays a sample file name in the **Current Destination** field at the top to help you control the resulting folder and file names (especially when using variables). After clicking on the Set button at the bottom of the dialog, this field shows the folder and file names as they would be created using the parameters you defined for the corresponding profile. Variables are also resolved using their current value.

### Profiles & Options

The dialog contains several sample FTP profiles and those defined using the **Quick Installation** wizard; you change these profiles or add new ones by clicking on **Add new profile** at the bottom of the dialog.

#### Note

FTP profiles created using the **Quick Installation** wizard are listed as **FTPQI1**, **FTPQI2**, etc. in this dialog.

Enter the **profile name** in the **FTP Profile n** field (where **n** is the current number of the profile). Remember to enter a descriptive name as this name is later displayed in other dialogs.

- **Current Destination:** Displays the full file name as it would be created using the **Directory Name** and **File Name** parameters defined in this profile. After clicking on the **Set** button at the bottom of the dialog, the name will be created according to these settings.

When using placeholders and variables, you can create dynamic directory and file names. This allows creating a folder structure using the year, name of the month, the time, and other information. For more information on variables, see the *Using Variables* topic in the camera help and the reference manual.

- **File Type:** Sets the type of data that will be transferred to the FTP server:
  - *Image from image profile:* Select the *Live or Event image* option or one of the image profiles (see section 7.8.7, *Image Profiles*) from the **Image Profile** list.
  - *MxPEG or JPEG clip:* Select *MxPEG clip file* to transfer an MxPEG video and audio clip or *Clip as JPEG file(s)* from the **Clip File Type** list. Set the remaining parameters as required (clip frame rate as well as the time before and after the event you would like to include in the clip).

You can define several FTP profiles with different parameters

Choose from different file formats (image or clip files)

**File Options:**

- **Temporary Name:** To prevent website users from seeing incomplete files during file transfer, this option allows setting a temporary file name. Once the transfer has been completed, the camera will rename the file, thus overwriting the old file. The *Enable, delete before rename* option is intended for Windows IIS servers, which do not support renaming to an existing file.
- **Event Directory:** If the file transfer has been triggered by an event, the camera can create the same event structure as in the event storage folder on a file server. For additional information on the event structure, see chapter 8, *Recording*.
- **Server Settings:** This section allows setting authentication data and connection type if they are different from those specified in the **Global Options** section at the top of the dialog.

**Using the profiles**

The FTP profiles defined in this dialog can be used in **Setup Menu > Actions** and **Messaging 2** for the **File Transfer Action (FT)** and the **Second File Transfer (FT2)** action. The FTP profiles are also used in **Admin Menu > Time Tasks** for transferring images and event archives. For additional information on this topic, see section 7.9, *Time Tasks*.

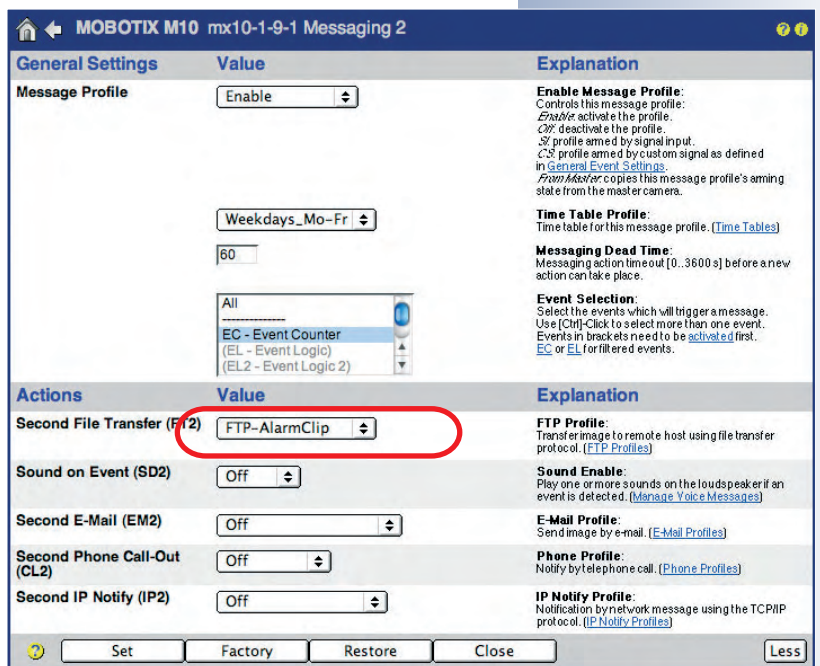
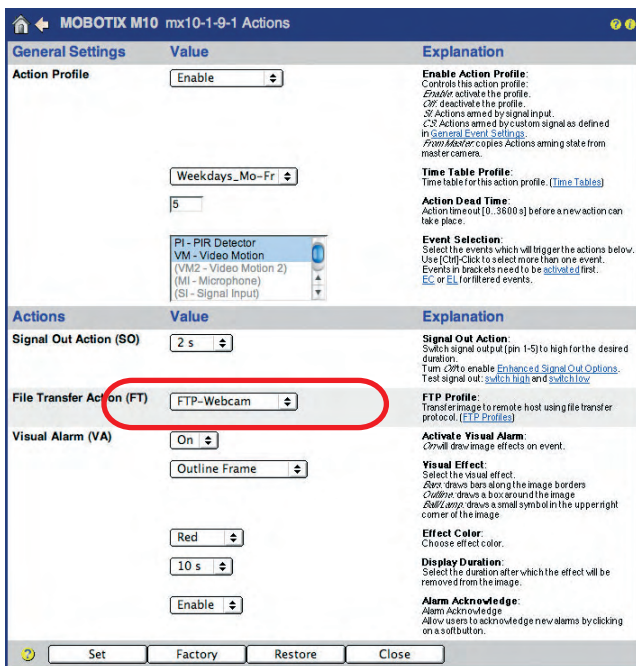

**Note**

Open **Admin Menu > Test Current Network Configuration** to test the FTP profiles one by one.

Use the Test Current Network Configuration dialog to test the FTP profiles



### 7.8.3 E-Mail (EM) Profiles

**Admin Menu > E-Mail Profiles** contains all parameters that are used by the MOBOTIX camera for sending e-mails containing image and text information.

Global Options	Value	Explanation
<b>Addressing</b>	\$(id.nam)@myhome.test	<b>Sender Address:</b> Default sender address. This parameter allows using <a href="#">variables</a> .
		<b>Reply Address:</b> Default reply address. <i>(Optional)</i>
<b>Mail Message</b>	Camera \$(id.nam) Address \$(id.et0) Time \$(fingerprint.timestamp) ---- generated by MOBOTIX camera	<b>Body Text:</b> Defines the default e-mail message. This parameter allows using <a href="#">variables</a> .
<b>Server Settings</b>	No authentication	<b>Authentication Method:</b> Select a default login method.
	smtp.myhome.test	<b>SMTP Server:</b> Name or IP address of the default SMTP server. <i>(Required)</i> The default port is 25. To use a different port, enter the number after the name or IP address separated by a colon.
Profiles & Options	Value	Explanation
<b>E-Mail Profile 1</b> AlarmMail		<input type="checkbox"/> Delete
<b>Addressing</b>	someone@myhome.test	<b>Receiver Address:</b> List of receivers. Use commas to separate several addresses. This parameter allows using <a href="#">variables</a> .
		<b>Sender Address:</b> Enter a sender address different from the global setting. <i>(Optional)</i>
		<b>Reply Address:</b> Enter a reply address different from the global setting. <i>(Optional)</i>
<b>Mail Message</b>	\$(id.nam): event=\$(fpr.eno) alarm	<b>Subject Text:</b> Mail subject. This parameter allows using <a href="#">variables</a> .
		<b>Body Text:</b> Define the mail message for this profile. This parameter allows using <a href="#">variables</a> .
<b>E-Mail Attachment</b>	Image from image profile	<b>Attachment:</b> Select type of e-mail attachments.
	Live or Event Image	<b>Image Profile:</b> Customize image profile for image attachment.
<b>Server Settings (Optional)</b>	(global setting)	<b>Authentication Method:</b> Select a login method.
		<b>SMTP Server:</b> SMTP server address.
		<b>POP3 Server:</b> POP3 server address.

#### Authentication Method:

- none
- SMTP login
- POP before SMTP

#### Global Options

As only one SMTP server is commonly used for sending e-mails, you should enter this server and the user name and password information (if required) in the **Global Options** section at the top of the dialog.

- The **Addressing** section sets the address information for the e-mails (sender and reply address). **Mail Message** allows setting a global text for e-mails. Make sure to replace the sample data (e.g. **\$(id.nam)@myhome.test**) by the proper data that is relevant for your installation.
- The **Server Settings** section sets the SMTP server, the authentication method (*SMTP Login*, *POP before SMTP*) and other user information, if required. Make sure to replace the sample SMTP server name by the proper server name for your installation.

## Profiles & Options

The dialog contains several sample profiles; you can change these profiles or add new ones by clicking on **Add new profile** at the bottom of the dialog.

Enter the **profile name** in the **E-Mail Profile n** field (where **n** is the current number of the profile). Remember to enter a descriptive name as this name is later displayed in other dialogs.

- **Addressing:** Enter the e-mail address of the recipient in the **Receiver Address** field; the **Sender Address** is only required if it is different from the one specified in the global options. If needed, you can also set the **Reply Address** in this section.
- **Mail Message:** Enter the e-mail **Subject** and the message text you would like to send (**Note:** See the sample **AlarmMail** profile for information on how to use variables in the message text).
- **E-mail Attachment:** Sets the type of data that will be attached to the e-mail:
  - *Image from image profile:* Select the *Live or Event image* option or one of the image profiles (see section 7.8.7, *Image Profiles*) from the **Image Profile** list.
  - *No attachment:* Sends the e-mail without attachment (i.e. only the text).
  - *MxPEG or JPEG clip:* Select *MxPEG clip file* to transfer an MxPEG video and audio clip or *Clip as JPEG file(s)* from the **Clip File Type** list. Set the remaining parameters as required (clip frame rate as well as the time before and after the event you would like to include in the clip).
  - *Image information (JPEG comment):* Send the information from the JPEG comment of the current live image.
  - *System Messages:* Sends the messages listed in **Admin Menu > System Messages**.
- **Server Settings:** This section allows setting authentication data, SMTP server and POP3 server information if they are different from those specified in the **Global Options** section at the top of the dialog.

## Using the profiles

The e-mail profiles defined in this dialog can be used in **Setup Menu > Messaging** and **Messaging 2** for the **E-Mail Action (EM)** and the **Second E-Mail (EM2)** action. The e-mail profiles are also used in **Admin Menu > Time Tasks** for automated sending of e-mails. For additional information on this topic, see section 7.9, *Time Tasks*.

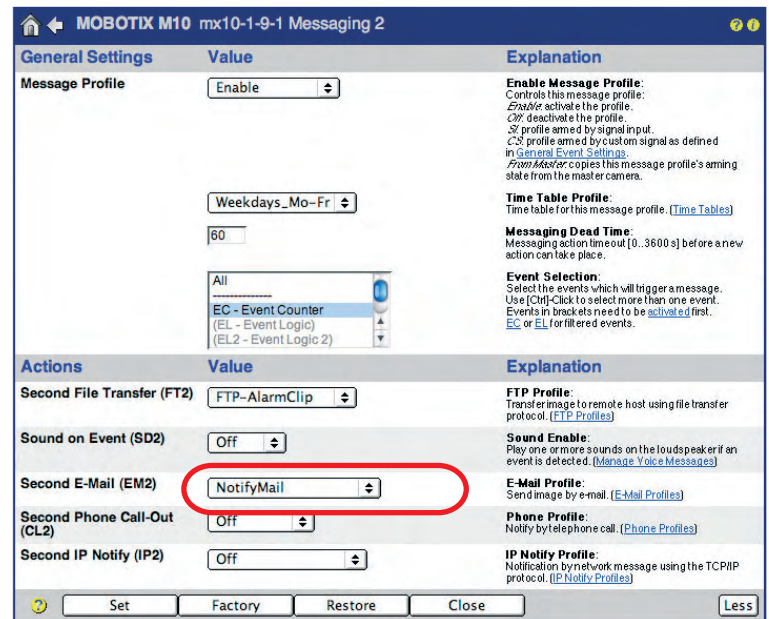
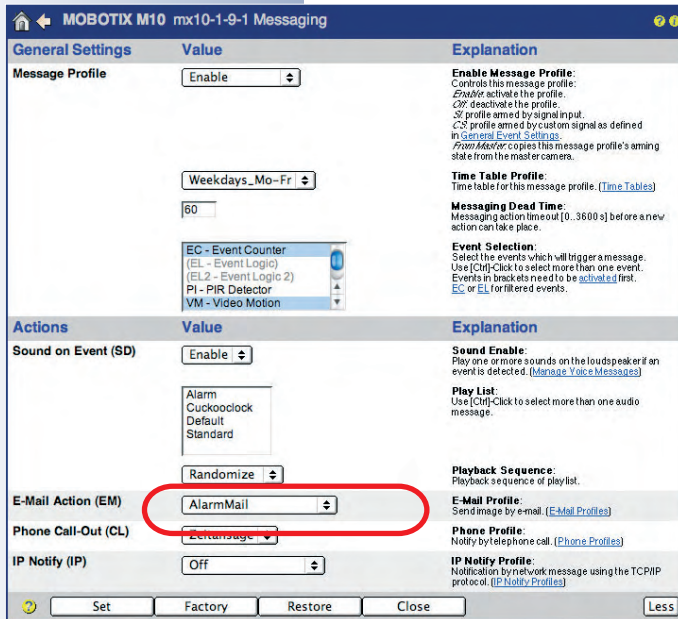

Use the Test Current Network Configuration dialog to test the e-mail profiles

### Note

Open **Admin Menu > Test Current Network Configuration** to test the e-mail profiles one by one.

7.8.4 Phone (CL) Profiles

The **Admin Menu > Phone Profiles** dialog allows defining phone numbers or phone number lists (several phone numbers). In case of an event (alert), the camera can use these phone numbers or SIP addresses (IP telephony) to place automated phone calls. You can also set a PIN for each profile, which has to be entered by the recipient of the call (using the touchtone keys of the phone) in order to acknowledge the alert.

The camera can place calls using ISDN or SIP connections (using the Ethernet interface for SIP).



In case of an alarm, the MOBOTIX camera can call you on your mobile/cell phone.

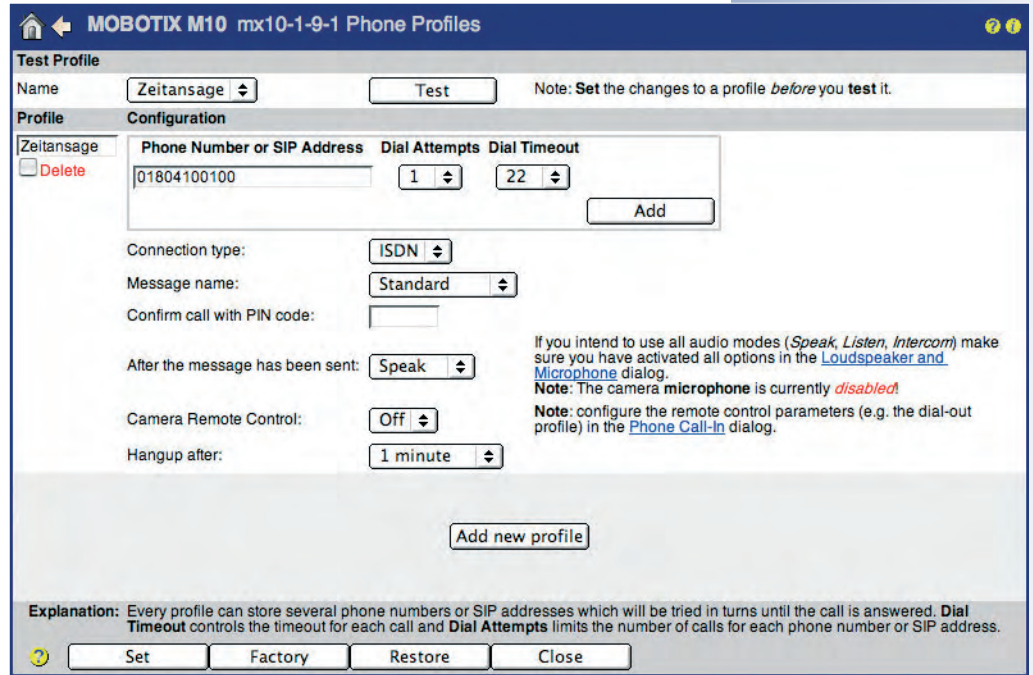

Test Profile

This section allows testing the defined profiles (make sure that you click on the **Set** button to save the changes to the profiles prior to testing). Clicking on the **Test** button will prompt the camera to call the phone number(s) of the selected profile until the call has been completed and acknowledged (if activated).

**Note**

Phone profiles created using the **Quick Installation** wizard are also listed in this dialog.



### Profiles & Options

The dialog contains some sample profiles; you can change these profiles or add new ones by clicking on **Add new profile** at the bottom of the dialog.

The **Profile** field contains the name of the profile. Remember to enter a descriptive name as this name is later displayed in other dialogs.

- **Phone Number or SIP Address:** Enter the **Phone Number or SIP Address**, which the camera should call in case of an alarm. Set the remaining parameters as required (**Dial Attempts** and **Dial Timeout**). Click on the **Add** button to add phone numbers or SIP addresses to this profile.
- **Connection type:** Sets the connection type for this phone profile. The profile can use either *ISDN* or *SIP* connections (Internet telephony). Make sure that the camera has been configured accordingly and that the connections have been set up (e.g. in **Admin Menu > VoIP Settings**).
- **Message name:** Select one of the voice messages available in **Admin Menu > Manage Voice Messages**. The camera will play back this message when it places the call.
- **Confirm call with PIN code:** If desired, enter a PIN code, which has to be entered by the recipient of the call (using the touchtone keys of the phone) in order to acknowledge the alert.

#### Note

If the camera can establish the phone connection, but no PIN (or an invalid one) is being entered (e.g. an unauthorized recipient or an answering machine), the camera will close the connection after a certain time and will call the next number of the phone profile.

- **After the message has been sent:** Select one of the audio modes *Speak*, *Hangup*, *Listen* or *Intercom*, if the corresponding devices have been activated in the **Admin Menu > Loudspeaker and Microphone** dialog. The camera will execute the selected option after it has played back the voice message.
- **Camera Remote Control:** Set this option to *On* if you would like to allow remote-controlling the camera using touchtone phone keys. It is only available if **After the message has been sent** has been set to *Speak*, *Listen* or *Intercom*.
- **Hangup after:** Set the maximum duration of a phone call using this parameter. It is only available if **After the message has been sent** has been set to *Speak*, *Listen* or *Intercom*.

Set a PIN code to make sure that the call is properly acknowledged

Camera remote control using a phone

**Using the profiles**

The phone profiles defined in this dialog can be used in **Setup Menu > Messaging** and **Messaging 2** for the **Phone Call-Out (CL)** and the **Second Phone Call-Out (CL2)** action. The phone profiles are also used in **Admin Menu > Time Tasks** for automated placing of phone calls. For additional information on this topic, see section 7.9, *Time Tasks*.

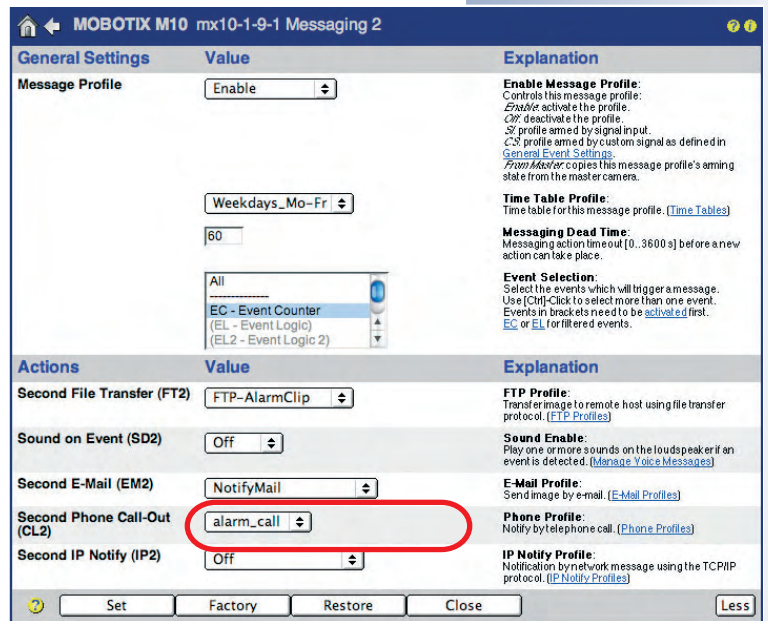
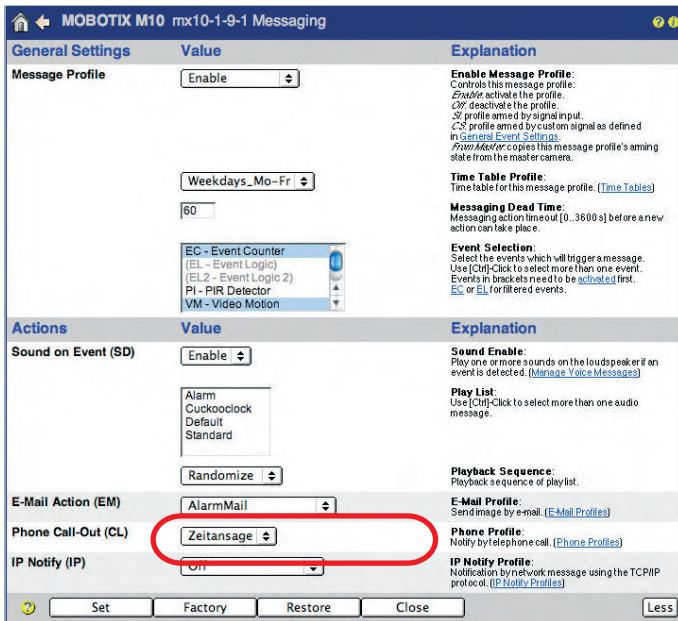

**Note**

Open **Admin Menu > Phone Profiles** to test the phone profiles one by one.



IP Notify (network) messages allow MOBOTIX cameras to exchange messages and commands

## 7.8.5 IP Notify (IP) Profiles

**Admin Menu > IP Notify Profiles** contains all parameters that are used for transferring network (IP) messages. Network messages can be sent from one MOBOTIX camera to trigger or to arm another MOBOTIX camera, they can send images via the network to a specific port of the receiving computer (using its IP address or DNS name) or they can be used for remote-controlling MxViewer.

Profiles & Options	Value	Explanation
<b>IP Notify Profile 1</b> SimpleNotify <span style="float:right">Delete</span>		
Destination Address	10.1.0.11:8000 Parallel send to all	<b>Destination Addresses:</b> Receiver IP address and port. Separate IP address and port using a colon. Enter one address per line.  <b>Send Order:</b> Send notification to one or more destinations. <i>Sequential</i> and <i>parallel</i> will send a notification to <b>each</b> destination address. <i>Send to next on error</i> will stop after the <b>first</b> successful notification or will try the next address if unsuccessful.
Data Protocol	Raw TCP/IP --next-image--	<b>Transfer Protocol:</b> Transfer notification data using these protocol headers.  <b>Separator for Raw TCP/IP:</b> Enter the separator for splitting several notification parts in <i>Raw TCP/IP</i> mode. Enter a unique string.
Data Type	Plain text Hello World! I'm \$(ID.NAM) with eve	<b>Notification Data:</b> Select type of IP notification data.  <b>Message:</b> Message to include in <i>Raw</i> notification data. When using HTTP protocol this text is used for QUERY_STRING in GET request. This parameter allows using <a href="#">variables</a> .
Send Port	0	<b>Port Number:</b> Send a message from this camera port (0 for automatic).
<b>IP Notify Profile 2</b> MultipleNotify <span style="float:right">Delete</span>		
Destination Address	10.1.0.37:8000 10.1.0.94:8000 Parallel send to all	<b>Destination Addresses:</b> Receiver IP address and port. Separate IP address and port using a colon. Enter one address per line.  <b>Send Order:</b> Send notification to one or more destinations. <i>Sequential</i> and <i>parallel</i> will send a notification to <b>each</b> destination address. <i>Send to next on error</i> will stop after the <b>first</b> successful notification or will try the next address if unsuccessful.
Data Protocol	Raw TCP/IP --next-image--	<b>Transfer Protocol:</b> Transfer notification data using these protocol headers.  <b>Separator for Raw TCP/IP:</b> Enter the separator for splitting several notification parts in <i>Raw TCP/IP</i> mode. Enter a unique string.
Data Type	Plain text Hello there! I'm \$(ID.NAM) with eve	<b>Notification Data:</b> Select type of IP notification data.  <b>Message:</b> Message to include in <i>Raw</i> notification data. When using HTTP protocol this text is used for QUERY_STRING in GET request. This parameter allows using <a href="#">variables</a> .
Send Port	0	<b>Port Number:</b> Send a message from this camera port (0 for automatic).
Add new profile		
Set Factory Restore Close Less		

### Profiles & Options

The dialog contains some sample profiles; you can change these profiles or add new ones by clicking on **Add new profile** at the bottom of the dialog.

Enter the **profile name** in the **IP Notify Profile n** field (where **n** is the current number of the profile). Remember to enter a descriptive name as this name is later displayed in other dialogs.

- **Destination Addresses:** Enter the IP addresses of the receiving network device (MOBOTIX cameras, PCs, etc.) and the port (separated by a colon ":"). If you would like to send the message to several recipients, enter each address in a separate line.
- **Send Order:** Sets how the network message will be sent:
  - *Sequential send to all:* Sends the network message to all IP addresses specified in **Destination Addresses**, one after the other. **Caution:** If one of

the destination IP addresses cannot be reached, the message will *not* be sent to the remaining addresses. Select the *Parallel send to all* option to prevent this from happening.

- *Parallel send to all*: Sends the network message to all IP addresses specified in **Destination Addresses** at once. The message will be sent to all specified IP addresses.
- *Send to next on error*: Sends the network message to all IP addresses specified in **Destination Addresses**, until one message has been delivered successfully. Once the message has been delivered successfully to an IP address, the camera stops sending the network message. The message is hence only delivered to the first recipient from the list of recipients, which successfully receives the network message.
- **Transfer Protocol**: Set the protocol to use for sending the network message.
  - *Raw TCP/IP*: Sends the raw data in TCP/IP packets.
  - *HTTP/1.0 Request*: Sends the message as an HTTP request. This also makes it possible to use variables. For more information on variables, see the *Using Variables* topic in the camera help and the reference manual.
- **Notification Data**:
  - *Plain text*: Sends the text as specified in the **Message** field (this field allows using variables).
  - *MxPEG or JPEG clip*: Select *MxPEG clip file* to transfer an MxPEG video and audio clip or *Clip as JPEG file(s)* from the **Clip File Type** list. Set the remaining parameters as required (clip frame rate as well as the time before and after the event you would like to include in the clip).
  - *Image information (JPEG comment)*: Send the information from the JPEG comment of the current live image.
  - *System Messages*: Sends the messages listed in **Admin Menu > System Messages**.
- **Send Port**: Sets the port for sending the network message (the default port 0 sets the send port automatically).

Supported data protocols



## Using the profiles

The IP Notify profiles defined in this dialog can be used in **Setup Menu > Messaging** and **Messaging 2** for the **IP Notify (IP)** and the **Second IP Notify (IP2)** action. The IP Notify profiles are also used in **Admin Menu > Time Tasks** for automated sending of network messages. For additional information on this topic, see section 7.9, *Time Tasks*.

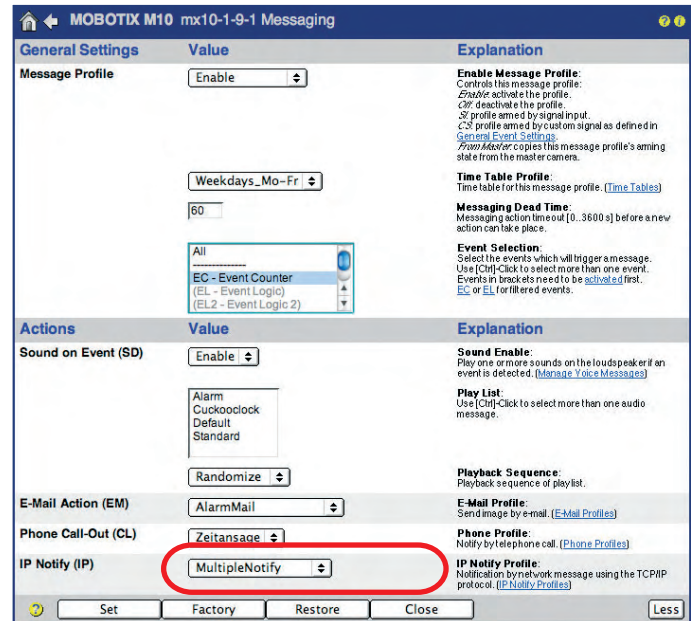
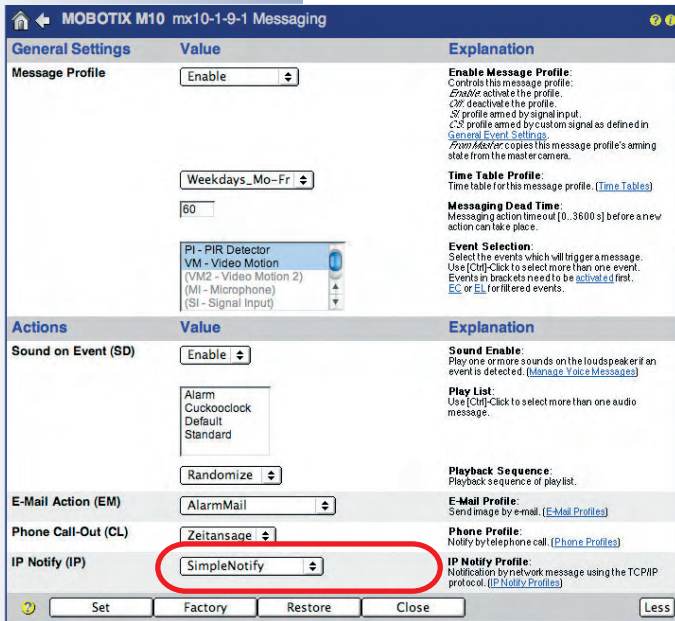

Use the Test Current Network Configuration dialog to test the IP Notify profiles

### Note

Open **Admin Menu > Test Current Network Configuration** to test the IP Notify profiles one by one.

7.8.6 Time Tables

The **Admin Menu > Time Tables** dialog allows defining time profiles. The camera can use these profiles (max. ten) to control the camera *Arming* (section 7.5), the *Actions* and the *Messages* (see section 7.7), for example. You could use the time tables to control the complete alerting mechanism or FTP transfers of the camera according to opening hours, company vacation times or holidays.

The **Time Tables** dialog contains two sections: **Custom Days** and **Time Tables**. The Custom Days section allows setting special date/time ranges (i.e. vacations, holidays, etc.). Once defined, you can use the custom days as custom time ranges in every time table profile.

The number of time ranges per profile depends on the camera model (Secure models: 12 time ranges per profile, IT models: 4 time ranges, Basic and Web models: 1 time range).

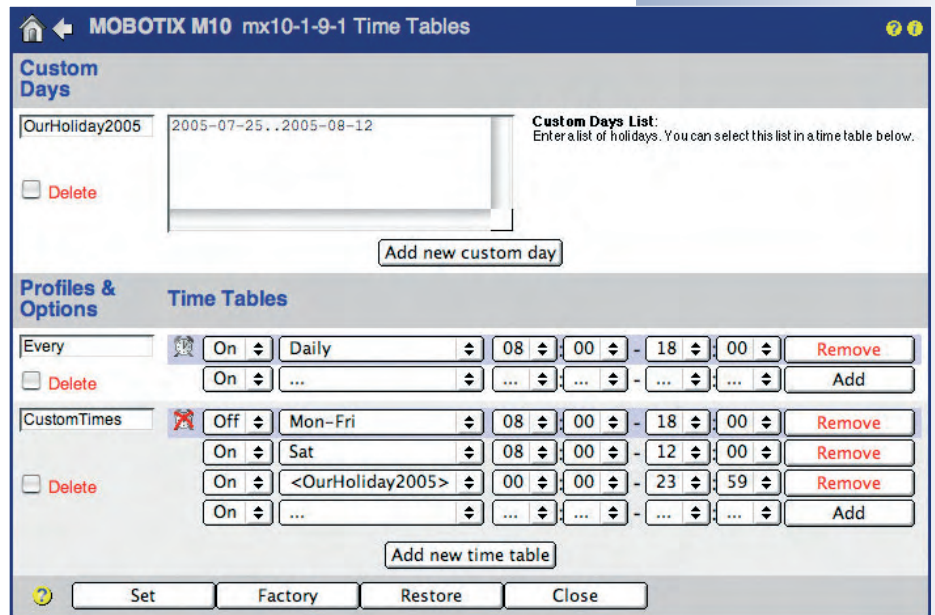

Time table profiles for scheduled camera control

Custom Days

Upon delivery or after resetting the camera, this dialog contains several sample custom days. Two of these custom days are also used in the sample **MyCustomTimes** time table profile.

Click on the **Add new custom day** button at the bottom of the dialog to create a new custom day. Enter a descriptive name for the custom day in the corresponding text field. Remember the name as it is added to the time range dropdown list of the time table profiles.

The custom days can specify single days (as in **NewYearHoliday**), time ranges (as in **OurHoliday2005**) and lists of days. It is also possible to mix days and day ranges in these lists. Lines starting with a # are indicating a comment (as in CustomDay3) and will be ignored by the camera software.

After changing the custom days, remember to click on the **Set** button as this will add the changed custom days to the time selector list of the time table profiles.



Custom days allow setting special time ranges (i.e. vacations, holidays, etc.)

You can define several time tables for different time ranges

### Profiles & Options

By factory default, this dialog contains several predefined time table profiles. Click on the **Add new time table** button at the bottom of the dialog to create a new time table profile. Enter a name for the time table profile in the corresponding text field. Remember to enter a descriptive name for the time table profile as this name is later displayed in other dialogs.

The lines of one time table profile constitute its **time ranges**:

- **Active time range:** The alarm symbol and the blue background color of a line indicate that this time period is currently active.
- **Switch status (On/Off):** Setting this option to *On* will prompt the camera to switch the status to *On* while the time range is active and to *Off* otherwise.
- **Day/Custom Day** Select the desired days of the week or one of the custom days defined above.
- **Start time:** Set the start time (*hour, minute*) of the time range.
- **End time:** Set the end time (*hour, minute*) of the time range.
- **Remove:** Click on this button to remove the time range.
- **Add:** Click on this button to add a new time range.

#### Caution

A time table profile is not required to fully cover the desired time range, without leaving any gaps. These gaps (undefined times) will always assume the **opposite state of the first time range**:

- If the first time range has been set to *On*, all undefined times have the status **off**.
- If the first time range has been set to *Off*, all undefined times have the status **on**.

**Using the profiles**

The following dialogs use **Time Table** profiles:

**Setup Menu:**

- **General Image Settings:** Used by the **Camera Time Switch** to automatically switch from one image sensor to the other.
- **Obscure Image Area (OA):** Controls the times during which the camera hides image areas from view.
- **General Event Settings:** Controls the arming status of the complete event and action processing and the recording functions.
- **Recording:** Activates or deactivates the recording functions.
- **Actions:** Activates or deactivates the action profile.
- **Messaging and Messaging 2:** Activates or deactivates the corresponding message profile.
- **Enhanced Signal Out Options:** Controls the arming status of the signal output.

**Admin Menu:**

- **Logo Profiles:** Automatic display of logos.

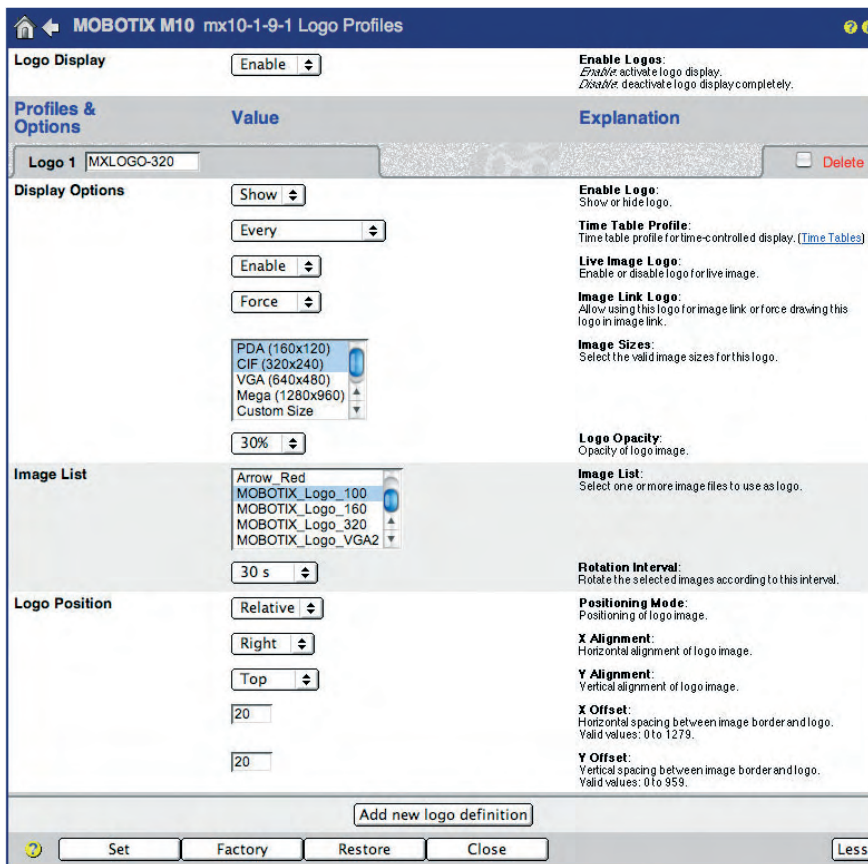

Time table profiles are used for a variety of different camera functions!





Custom image sizes using image profiles (e.g. SKYLINE)

## 7.8.7 Image Profiles

The **Admin Menu > Image Profiles** dialog allows defining individual images with specific properties. The MOBOTIX camera could update mega pixel images (1280x960 pixels) on a web server using a corresponding profile, although the Live screen only shows VGA images (640x480), for instance.

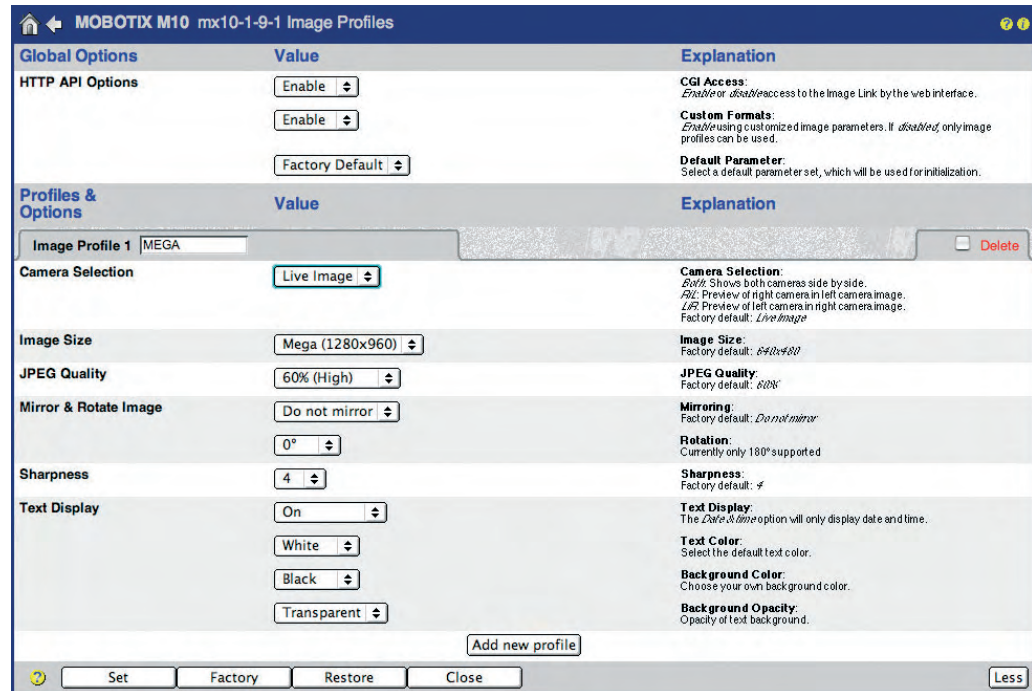
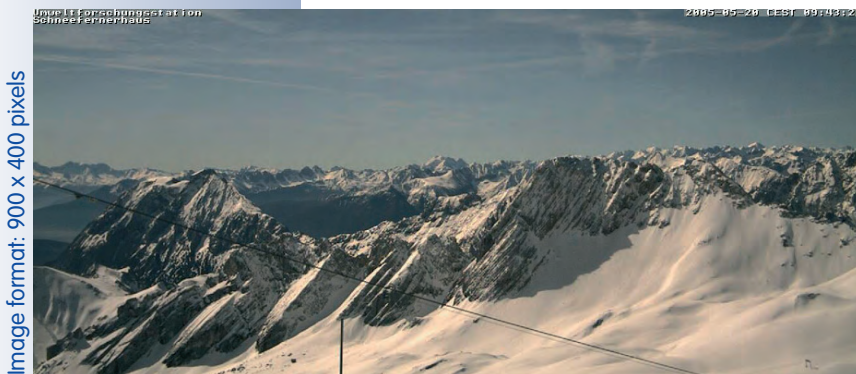

Image profiles also allow creating images with specific resolutions (sizes), JPEG quality, sharpness settings as well as mirroring and rotation settings. You can even set a different type and form for the text displayed on the images (independent of

the settings in the **Setup Menu > Text & Display Settings** dialog; see section 5.5.3, *Text Settings*). Image profiles also control logos and graphics (using logo profiles) in the camera image, (see section 7.8.8, *Logo Profiles*).

The image profiles defined in this dialog can be used to transfer images using FTP or e-mail, for example.



### Global Options

The **Global Options** section allows deactivating the **HTTP API functions** (see section 11.5, *HTTP API*), which allow remote-controlling the camera from other applications. Deactivate the **Custom Formats** option to prevent the camera from creating customized image formats that have *not* been defined in the image profiles.

The **Default Parameter** specifies, which image format or profile the camera will use if the command `http://10.x.x.x/cgi-bin/image.jpg` is used without specifying an image profile (as opposed to `http://10.x.x.x/cgi-bin/image.jpg?imgprof=MEGA`).

#### Note

Section 5.5, *Image Control*, provides more information on these options.

### Profiles & Options

The dialog contains some sample profiles; you can change these profiles or add new ones by clicking on **Add new profile** at the bottom of the dialog.

Enter the **profile name** in the **Image Profile n** field (where **n** is the current number of the profile). Remember to enter a descriptive name as this name is later displayed in other dialogs.

- **Camera Selection:** Select the image sensor to use for this profile. The list only contains the options available on this camera model.
- **Resolution:** Select the image resolution to use for this profile. The list only contains the resolutions available on this camera model.
- **JPEG Quality:** Select the JPEG quality to use for this image profile.
- **Mirror & Rotate Image:** Select the mirroring and rotation options for this profile.
- **Sharpness:** Select the sharpness setting to use for this image profile.
- **Text Display:** Set the options for formatting the displayed text (text and background color, background opacity).
- **Date and Time:** Select the format of the displayed time for this image profile.
- **Comment:** Set the comment text for this image profile that is displayed in the image. It is also possible to use variables in this field.
- **Logo Profile:** Select one or more logo profiles, which control how to display logos in the images.

#### Caution

Click on **Set** at the bottom of the dialog to temporarily store the changed and added profiles. Click on **Close** to close this window and to store the configuration in the permanent flash memory so that the settings are available after the next reboot.



### Using the profiles

The image profiles can be used in the **Admin Menu > FTP Profiles** and the **Admin Menu > E-Mail Profiles** dialogs.

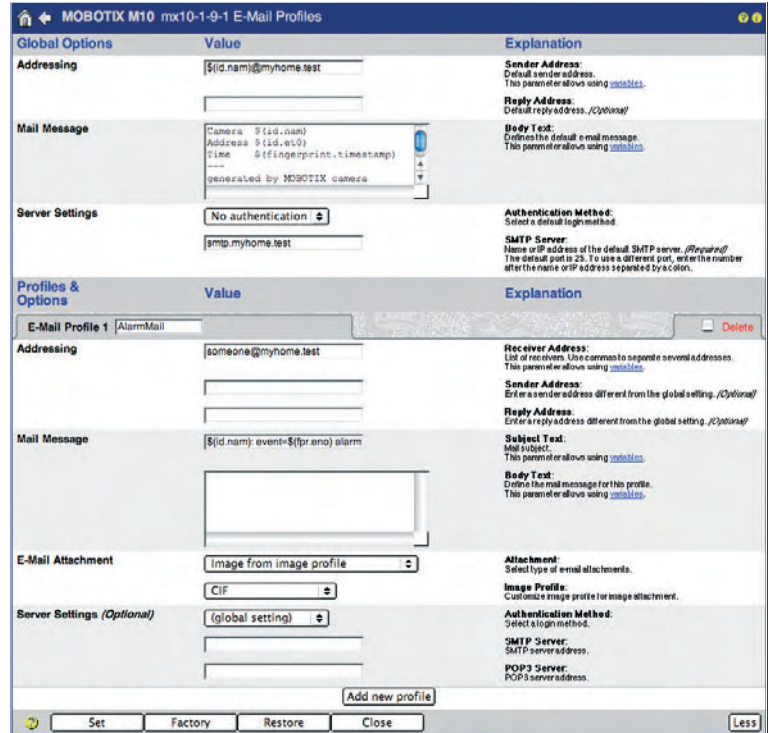
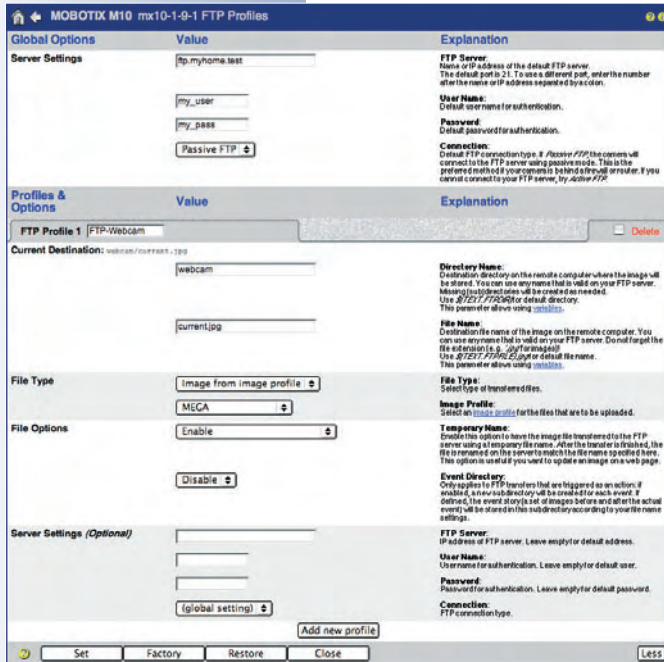

Images from image profiles can be tested using the preview link

**Note**

Open **Admin Menu > Image Profiles** to test the image profiles one by one. Clicking on the link at the bottom of each profile will open a new window with the resulting image.

7.8.8 Logo Profiles

The **Admin Menu > Logo Profiles** dialog allows using the camera's default graphics files or those defined in the **Admin Menu > Manage Graphics Files** dialog as logos. Section 6.5.2, *Manage Image Files*, contains more information on this topic.

A logo profile can also be linked to a time table, and can set the position, opacity and the rotation interval if several logos are part of this profile. It is also possible to create a frame around the camera image using the Frame positioning mode of the logo profile.

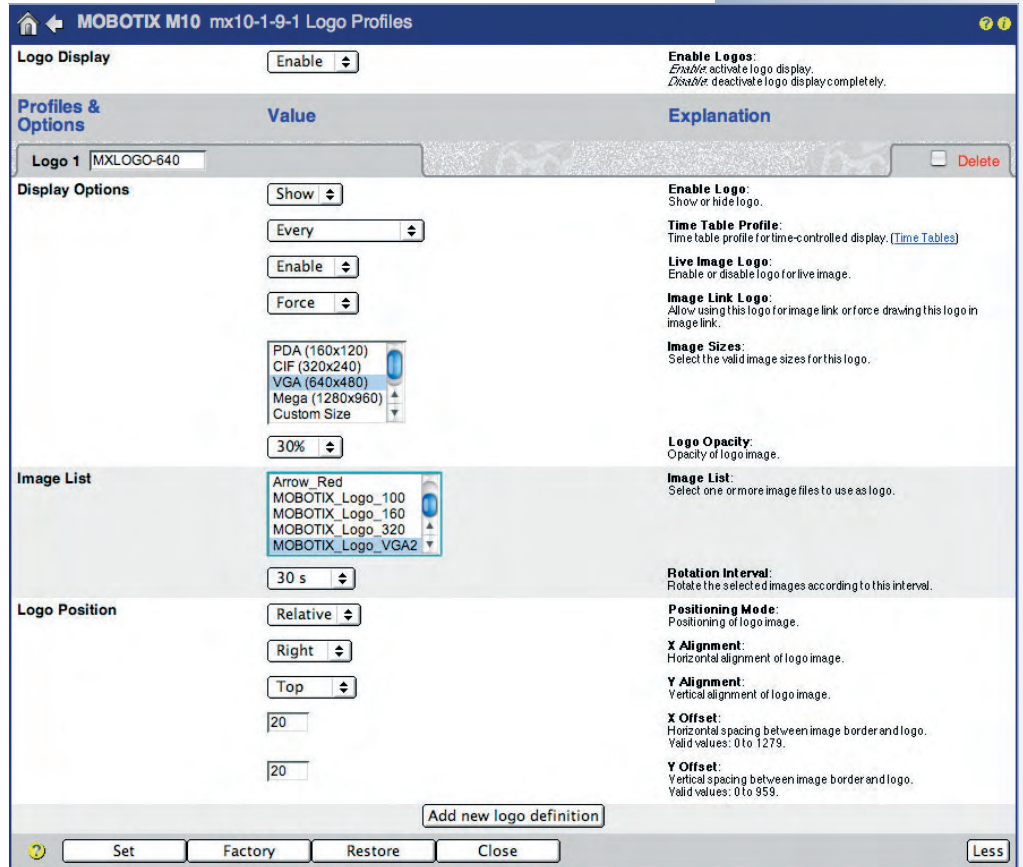

Note

The MOBOTIX camera can automatically load graphics files and logos from a web or FTP server as configured in **Admin Menu > Manage Graphics Files**. For additional information on this topic, see section 5.6.2, *Manage Image Files*.



Activate the Logo Display main switch!

### Global Options

The **Logo Display** parameter is the main switch for all logo profiles. Disabling **Logo Display** and clicking on the **Set** at the bottom of the dialog will remove all logos from all camera images.

### Profiles & Options

The dialog contains some sample profiles; you can change these profiles or add new ones by clicking on **Add new logo definition** at the bottom of the dialog.

Enter the **profile name** in the **Logo n** field (where **n** is the current number of the profile). Remember to enter a descriptive name as this name is later displayed in other dialogs.

- **Display Options:**

- **Enable Logo:** Activates (*Show*) or deactivates (*Hide*) the logo profile.
- **Time Table Profile:** Select the desired time table profile if displaying the logo should be controlled by a time table.
- **Live Image Logo:** This option allows using the logo for the live image of the camera.
- **Image Sizes:** Select the image sizes (resolutions) on which the selected logo(s) are to be displayed. The logo will only be displayed on the camera image for the resolutions selected in this profile.
- **Logo Opacity:** This parameter controls how the logo will cover the camera image (*100%* will cover the background completely, *10%* to *90%* will let you see the camera image through the transparent logo).

- **Image List:**

Select the graphics files, which are to be displayed as logos one after the other. **Rotation Interval** sets the interval, during which each logo is visible (only if more than one graphics file has been selected).

- **Logo Position:**

- **Positioning Mode *Relative*:** Displays the logo at a relative position. The logo position and the offset are specified using the **X/Y Alignment** parameters (*Left, Center, Right*) to set a reference, and the **X/Y Offset** parameters.
- **Positioning Mode *Frame*:** Uses the logo as a frame, where the horizontal frame width and the vertical frame height are set using the **X/Y Border** parameters.

Animated image sequences in the live image

### Using the profiles

Logo Profiles can be used on the one hand to display logos according to the current resolution of the camera's live image. On the other hand, the logo profile can force displaying the logo, even if the images are obtained from the camera using HTTP API commands (*Image Link Logo* parameter). Furthermore, logo profiles can be used by *image profiles* to simultaneously display one or more logo profiles in the camera image, (see section 7.8.7, *Image Profiles*).

www.naturbad-biebertal.de © Stadt Menden (Sauerland) 2005-06-16 DEUT 10:42:04



## 7.9 Time Tasks

### 7.9.1 Overview

The time task feature of the MOBOTIX camera allows **executing specific tasks at precise points in time—down to the minute**. The tasks comprise FTP file transfers, sending e-mails, phone calls, network messages, playing back sound files, executing administrative tasks (rebooting the camera, loading configuration settings) as well as the scheduled triggering of events. This very powerful feature **can execute tasks such as the following**:

Update the live image on the FTP (web) server every 15 minutes in January and April between 6 am and 11 am and between 3 pm and 7 pm, but only on Mondays, Tuesdays, Wednesdays and Sundays.

Example: Time Tasks

Task	Minutes (0.. 59)	Hours (0.. 23)	Days of Month (1.. 31)	Months (1.. 12)	Week Days (0.. 7)	Options
FTP "FTP-Archiving" current image	*/15	6-11	*	1,4	*	<input type="checkbox"/> Inactive <input type="checkbox"/> Delete
FTP "FTP-Archiving" current image	*/15	15-19	*	1,4	1-3,7	<input type="checkbox"/> Inactive <input type="checkbox"/> Delete
Select task...	*	*	*	*	*	<input type="checkbox"/> Inactive

### 7.9.2 Time Tasks

Open **Admin Menu > Time Tasks** to configure a scheduled task. Each row contains the information for one task. Select the type of task you would like to execute in the first column. The remaining five fields allow setting the precise times at which the selected task will be executed. In addition, you can deactivate tasks temporarily without having to delete them.

#### Selecting a Task

- **Restore last configuration:** The camera can restore the configuration with all camera parameters, which was last saved to the flash memory of the camera. This also means that all (temporary) changes not stored in the flash memory will be discarded.

For example, you might use this task to regenerate all cameras that are accessible directly from the Internet on a daily basis. Users may thus change camera settings for testing purposes, but the camera will return to the last configuration stored in the camera's flash memory at the specified points in time.

- **Rebooting the camera:** This task will reboot the camera at the specified points in time. By factory default, the camera will reboot every morning at 3:36 am.

Available tasks

A reboot usually makes sense if a camera is connected to DSL and uses its DynDNS client to update the DNS entry. Cameras, which are subjected to high amounts of ultra-violet or EM radiation (e.g. at high altitudes, Antarctica, etc.) should also run this task to prevent malfunctioning. A reboot resets the camera to a predefined state, even if some parts of the camera software are not working properly. This feature also ensures permanent availability of cameras, which are hard to reach (e.g. on power or cable car towers, wind generators, offshore rigs) and thus saves costs and manpower.

It is not recommended to deactivate or delete this task. Note that the camera will not be available for about one minute after rebooting.

- **FTP current image:** This task will execute the selected FTP profile at the specified points in time to update a camera image on a website, for example.

If the list does not contain an FTP profile, create a profile **Admin Menu > FTP Profiles**.

- **FTP event tar file:** This task will execute the selected FTP profile at the specified points in time. All stored images or video sequences are compressed into one archive file and this file is uploaded to a website or an FTP server. Note that the archive file may get large as it contains all stored images.

Apart from the stored JPEG images, the archive file also contains an index.html file with JavaScript code. This HTML file allows playing back the event images and the corresponding pre- and post-alarm images in a browser window without requiring access to the camera itself. It thus allows evaluating the images without using an additional application and independent of any operating system; all you need is a JavaScript-enabled browser.

If the list does not contain an FTP profile, create a profile **Admin Menu > FTP Profiles**.

- **E-Mail:** This task will execute the selected e-mail profile at the specified points in time to send a camera image to an e-mail account, for example.

If the list does not contain an e-mail profile, create a profile **Admin Menu > E-Mail Profiles**.

- **Phone Profile:** This task will execute the selected phone profile at the specified points in time to place a phone call using ISDN or IP telephony (SIP), for example (see also chapter 9, *Telephony Functions*). If the list does not contain a phone profile, create a profile **Admin Menu > Phone Profiles**.

By factory default, the camera will reboot every morning at 3:36 am

All images in the internal image storage will be deleted when rebooting the camera!

Scheduled updating of an image on a website



- **IP Notify:** This task will execute the selected IP Notify profile at the specified points in time to send a network message to another network device, for example (MOBOTIX camera, computer, etc.).

If the list does not contain an IP Notify profile, create a profile **Admin Menu > IP Notify Profiles**.

- **Play voice message:** This task will play back the selected sound file at the specified points in time. Use this feature to play back sound files that announce breaks at school or signal the end of a shift at a factory, for example.

To record or upload your own sound files, open **Admin Menu > Manage Voice Messages**.

### Numeric Values of the Time Fields

Time Field	Possible Values
Minutes	Minutes from 0 to 59
Hours	Hours from 0 to 23
Days of Month	Days of the month from 1 to 31
Months	Months from 1 to 12
Week Days	Days of the week from 0 to 7, where 0 = Sunday, 1 = Monday, 6 = Saturday, 7 = Sunday

Possible Values

### Examples

Minutes	Hours	Days of Month	Months	Week Days	Explanation
*/10	7-21	*	*	*	The task is executed daily every 10 minutes between 7 am and 9:50 pm every day.
*/10	7-15	*	6-9	2,4	The task is executed every 10 minutes between 7 am and 3:50 pm on Tuesdays and Thursdays from June to September.

Examples for Time Tasks; see the camera's online help for more examples

**Five time fields** set the points in time for executing a task:

- **Minutes (0 to 59)**
- **Hours (0 to 23)**
- **Calendar days (1 to 31)**
- **Months (1 to 12)**
- **Week Days (0 to 7)**

0=Sunday, 1=Monday, ... 6=Saturday, 7=Sunday

#### Note

When filling out the time fields, you can only use **numbers and the \* , / - characters**. At least one time field has to contain a number. A task is rejected if you have entered asterisks in every time field (this is the default setting).

#### Combined Time Field Entries

You can enter a numeric value for a point in time, an asterisk "\*", a list, a range or an interval:

- **0 to 9 (numeric value)**

A numeric value means "at this point in time". 12 in the Minutes time field means at every 12th minute of the hour (8:12, 9:12, 10:12, etc.).

- **\* (Asterisk)**

The asterisk "\*" means "every".

\* in the Hours time field means at every full hour (8.00, 9.00, 10.00, etc.).

- **, (List)**

Entries separated by "," will be interpreted one after the other.

3,6,8 in the Days of Month time field means on the 3rd, 6th and 8th day of every month.

- **- (Range)**

Numeric values separated by a "-" indicate a range.

7-9 in the Month time field means from the 7th to the 9th month, i.e. from July to September.

Note that the smaller numeric value always comes first. The entry "22-5" provokes an error. Instead, enter the range as "22-23, 0-5".

Entries of the time fields

- / (Interval, from ... to)

You can shorten a list by using a slash "/".

7-17/2 in the Hours time field means from 7 am to 5 pm, but only every second hour, e.g. 7:00, 9:00, 11:00, ... 17:00. This entry would correspond to the list "7,9,11,13,15,17".

- /\* (Interval, every x ...)

You can combine an interval with an asterisk:

\*/10 in the Minutes time field means at every 10 minutes, starting with 0, e.g. 8:00, 8:10, 8:20, 8:30, etc.

For additional examples on time tasks, see the camera help and the reference manual.

### Options

- **Inactive:** The task has been deactivated, but the definition remains stored in the configuration.
- **Delete:** The task will be deleted from the configuration as soon as you click the **Set** button.

### 7.9.3 Scheduled Tasks Using the Time Task (TT) Event

The **Time Task Event** can trigger an event at the specified points in time. Make sure that the **Time Task (TT)** event has been activated in the **Setup Menu > Event Settings** dialog.

The **Time Task** event works similar to the Periodic Event. The difference between the two events rests in the fact that the Time Tasks can trigger events at specific points in time, whereas the Periodic Event only allows setting an interval between two succeeding events.

The Time Task event can thus trigger a message or an action (**Setup Menu > Messaging, Setup Menu > Actions**) or it can trigger the camera's recording feature (**Setup Menu > Recording**).

You could use this feature to have the MOBOTIX camera send you an e-mail with its status information five times a day to check on the camera's status, for example. Another example: The camera could remove the lock from a door every morning at 8 am by switching its signal input.

#### Note

The **shortest interval** of the Time Task event is **one minute**.

Time Tasks can be executed precisely at the specified points in time

Time Task events can trigger messages and actions periodically, e.g. to send an e-mail





## 8 RECORDING

### 8.1 Overview

The multitude of recording features of MOBOTIX network cameras quite impressively demonstrates the state of the art of image processing and image storage. At the same time, its vast features and the flexible design allow MOBOTIX cameras to fulfill very diverse and demanding requirements—at a competitive price, compared to other products.

#### Concept: Decentralized and Intelligent

The concept of the MOBOTIX cameras can be summarized as follows: "Many intelligent camera systems, which are easily scalable, are working together in a network environment where failures of single components do not affect overall performance." This is also the motto of the recording concept as every camera can decide individually, when, where and how the video and audio data are stored.

#### Extendability: Cost-efficient Standard Components

Ever-increasing security requirements always represent a challenge. MOBOTIX cameras meet this challenge in many ways: Due to the individual system's intelligent design, no special requirements are needed in the recording hardware. The benefit: all you need for applications are cost-efficient **standard components**. This makes it possible for up to **30 MOBOTIX cameras to record in event-controlled manner on a single standard PC** (P4 with 3 GHz) with **up to 30 fps each, including audio**. When more cameras are required, you can easily add more standard PCs.

#### Storage Location: In the Camera or on File Servers

Depending on the application, image storing may pose quite different requirements. When you are supposed to set up a temporary parking lot monitoring system, for example, it is perfectly sufficient for the camera to be able to store up to 2,500 images (640x480) in its **internal ring buffer storage**. For monitoring an airport, which requires storing video sequences for a longer period of time, you can use several file servers with RAID disks, NAS (Network Attached Storage) or SAN (Storage Area Network) systems providing a storage capacity of up to the Terabyte range.

The MOBOTIX Concept

Internal and external storage options

Kameramodel	X	-
X	X	-
-	X	X
-	-	X

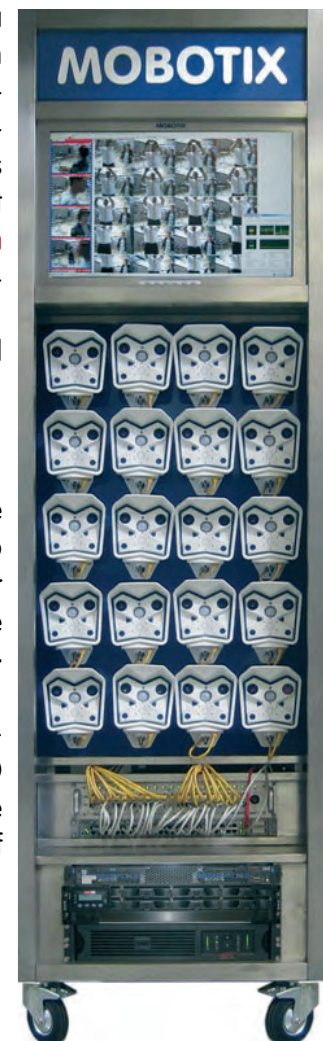

MOBOTIX camera rack

MOBOTIX cameras (IT models and up) can use computers with common operating systems (such as Windows Professional/Server starting with version 2000, Linux/UNIX and Mac OS X from version 10.3) as file server without the need to install additional software on the individual system. The cameras use the file server's disks as **external ring buffer storage** for video and audio data. They also can play back the stored video and audio data from the external ring buffer.

**MXNFS Server** is a CD-based operating system by MOBOTIX, which converts a standard PC into a Linux file server in a couple of minutes. Again, the cameras can use this server as external ring buffer storage.

Every camera manages its ring buffer storage autonomously. Once the defined storage limits or number of events have been reached, the camera automatically deletes the oldest events.



**Security Features: Buffering and File Server Monitoring**

Even short **network downtimes** do not result in lost video data. In such a case, MOBOTIX cameras temporarily store the video and audio data in the **internal ring buffer** and update the data on the file server data once it is online again. If the file server downtime persists, the camera can report this situation in several ways (phone call, e-mail, etc.) and automatically switch to another file server.

Ring buffer prevents loss of data

**Time Tables: Camera Schedules**

You forgot to **activate** the MOBOTIX camera's recording feature before leaving the store? No problem, the camera will do this automatically. The master camera (Secure model) follows its current **time table** and has activated all other cameras accordingly. Now all cameras will record events until next morning and will send an alarm, if necessary. Vacation times and holidays can also be integrated into the time tables.

Time table profiles for scheduled tasks

By the way, precision is another strong point of the MOBOTIX cameras. The build-in **time synchronization** feature automatically adjusts the camera time with public or local time servers.

**Recording Modes: Event-Controlled or Continuous**

Why would you want to review hours of video recording of a parking garage entrance in order to locate one specific vehicle? MOBOTIX cameras record a period of time before and after an alarm in an **event-controlled manner** (Snap Shot or Event Recording) in order to minimize the storage capacity and bandwidth requirements. In our example of the parking garage entrance, the camera's recording feature is triggered as soon as a vehicle or person enters the video motion window. The video and audio data are recorded for the defined period of time.

When long-term recording is required, however, MOBOTIX cameras can record efficiently using a lower frame rate (and continuous audio). Once the camera detects specific events, it automatically switches to the full frame rate. Events recorded and

Kameramodel	
X	-
X	-
-	X
-	X

stored in this way are easily found later on as they are stored with date/time codes and a unique event number.

For all recording modes, the camera can automatically extend the recording time when certain events occur and, thus, record an alarm with as many continuous images as possible.

### Recording Formats: MxPEG or JPEG

One of the top requirements in security technology is the speedy **transfer and display** of video and audio data. As no other format can fulfill this requirement, MOBOTIX has developed its own transfer format **MxPEG**, which allows transferring video data using only one third of the usual bandwidth and also can transport the audio data from the camera microphone. In order to display the stored MxPEG-encoded video and audio data, you can either use Windows Internet Explorer with **MxPEG ActiveX plugin** or **MxViewer** (available for download from [www.mobotix.com](http://www.mobotix.com) free of charge).

The MxPEG concept



For long-term recording, using the **JPEG** format is a good choice, too, as this single image format represents a good compromise between image quality and required storage capacity.

Independent of the chosen format, a **JavaScript-enabled browser** is sufficient to evaluate the event images.

### Playback: Via the Cameras or Directly

Once the video data has been recorded, it can be played back using the MOBOTIX camera's integrated **Player**. When playing back the events, you can choose to only see the event images (recorded when the event had been triggered) or the full video sequence with pre- and post-alarm images. Using the integrated database features of the MOBOTIX camera also allows searching for events recorded at a specific data and time. If the audio data had been included in the recording, the sound of the camera microphone will also be played back.

Video playback using camera's Player or MxViewer

The following methods are also available in order to access the recorded video data (apart from using the camera's integrated player features):

**MxViewer** can directly access the video data of the alarms in the shared folder of a file server without connecting to the camera. This application also shows alarm lists and has a multitude of other useful features.

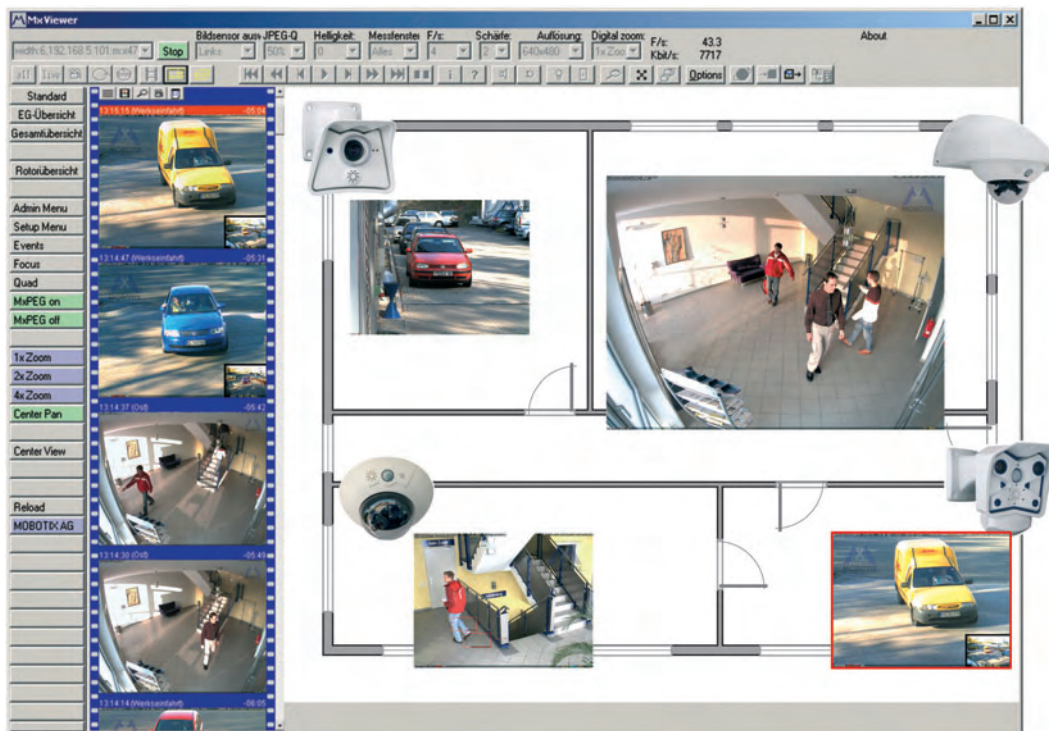

MxViewer

### Time-Controlled Recording: Documenting and Presenting

Be it for a web site or for documenting the progress of a construction site in addition to its security tasks, the MOBOTIX camera can automatically store **history images** at certain intervals or at specific points in time. Downloading these images will automatically include an HTML player to immediately view the downloaded images. You could also produce a digital time-lapse video using some readily available tools.

### File Transfer Using FTP: Also Used for Security Purposes

Apart from its recording features, the MOBOTIX camera's **image storage functions via FTP** also deserve mentioning. The camera can use FTP to update images on a web site, but it can also store a video clip (including the sound from the camera microphone!) on a remote FTP or web server for backup purposes.

For more information on file transfer to an FTP server see sections 7.7.2, *FTP File Transmission (FT Action)*, and 7.8.2, *FTP Profiles*.

Simple FTP file transfers



## 8.2 Recording Modes

### 8.2.1 Configuring the Recording Modes

Open the **Setup Menu > Recording** dialog to change the **Recording Mode** and the corresponding settings. This dialog is important as it activates (arms) the whole recording mechanism of the camera. **The camera will only record images, video and audio, if recording has been armed.**

Arm the camera!

General Settings	Value	Explanation
Arming	Enable	<b>Arm Recording:</b> Controls camera recording. <i>Enable:</i> activate Recording. <i>Off:</i> deactivate Recording. <i>SI:</i> Recording armed by signal input. <i>CS:</i> Recording armed by custom signal as defined in <a href="#">General Event Settings</a> <i>From Master:</i> copies Recording arming state from master camera.
	(no time table)	<b>Time Table Profile:</b> Time table profile for time-controlled recording. ( <a href="#">Time Tables</a> )
Storage Settings	Value	Explanation
Recording (REC)	Event Recording	<b>Recording Mode:</b> Type of event and story recording. <i>Snap Shot Recording:</i> stores single JPEG pictures. <i>Event Recording:</i> stores stream files for every event using MxPEG codec. <i>Continuous Recording:</i> continuously streams video data to stream files using MxPEG codec.
	Include audio	<b>Record Audio Data:</b> Store audio data in stream file if available. Enable and configure <a href="#">microphone</a> .
Start Recording	PI - PIR Detector	<b>Start Recording:</b> Select the events which will start recording. Use [Ctrl]-Click to select more than one event. Events in brackets need to be <a href="#">activated</a> first. <a href="#">EC</a> or <a href="#">EL</a> for filtered events.
	Max fps	<b>Event Frame Rate:</b> Recording speed if an event is detected, in frames per second.
	2 s	<b>Recording Time Before Event:</b> Additional recording time before an event stream.
	10 s	<b>Recording Time:</b> Time to include in recorded stream after an event has occurred.

#### Note

Inexperienced users should start using the preset **Snap Shot Recording** to get experience with the MOBOTIX camera's recording features.

General procedure

Follow **this procedure** to properly configure recording:

- 1) Activate the **Arm Recording** parameter.
- 2) Select the **Recording Mode**:
  - a) Set the following parameters for **Snap Shot Recording (JPEG)**:
    - **Events**, which will start a recording
    - Number of **pre- and post-alarm images**
    - **Snap Shot Interval** (e.g. 250 ms = 1/4 second)

- b) Set the following parameters for **Event Recording (MxPEG)**:
  - **Events**, which will start a recording
  - **Event Frame Rate** (e.g. 12 frames per second)
  - **Record Audio Data** (*Off or Include Audio*)
  
- c) Set the following parameters for **Continuous Recording (MxPEG)**:
  - **Continuous Recording Frame Rate** (e.g. 2 frames per second)
  - **Events**, which are increasing the frame rate
  - **Event Frame Rate** (e.g. 12 frames per second)
  - **Record Audio Data** (*Off or Include Audio*)

**Note**

Make sure that *MxPEG* has been activated in **Setup Menu > JPEG Settings**. This will ensure that the MOBOTIX camera uses the highest possible frame rate (see also section 4.10, *Fast Video Streaming*).

**8.2.2 General Settings of the Recording Modes**

- **Arm Recording**
  - *Enable*: Activates recording.
  - *Off*: Deactivates recording.
  - *SI Closed (low)*: The camera only records if the signal output is closed.
  - *SI Open (high)*: The camera only records if the signal output is open.

In order to control the camera's arming status in a scheduled manner, you can select one of the **Time Table profiles**. This selection box is available if **Arm Recording** has been set to *Enable*, *SI Closed* or *SI Open* (see also section 7.8.6, *Time Tables*).

- **Terminate Recording (TR)**

This function will completely **deactivate** the camera recording after a preset event has occurred (if configured, the recording will continue during the **Time Before Terminate**).

Recording will be reactivated only after user intervention, e.g. by clicking on the "*Click here to resume recording*" link in **Setup Menu > Recording**. As an alternative, you could define the **Restart Actions** softbutton to reactivate recording (see section 4.9, *Configuring Softbuttons*).

**Caution**

If Terminate Recording has temporarily deactivated the recording feature, images and video clips will only be recorded again, if you manually restart recording.



A terminated recording has to be restarted manually (link, softbutton)!

**Setup Menu > Recording**

Snap Shot Recording with up to 50 pre and 50 post-alarm images



Setup Menu >  
Recording >  
Snap Shot Recording

### 8.2.3 Settings of Snap Shot Recording

**Snap Shot Recording** can be used to record images in an event-controlled manner. The camera can also create image sequences of up to 50 JPEG images before and 50 after the actual event (Basic/Web models: 3, IT models 10 images before and after the event). Use the MOBOTIX camera's Player screen to view the **JPEG images**; they can also be opened using any graphics or image viewer application.

#### Settings

Storage Settings	Value	Explanation
<b>Recording (REC)</b>	Event Recording	<b>Recording Mode:</b> Type of event and story recording. <i>Snap Shot Recording</i> stores single JPEG pictures. <i>Event Recording</i> stores stream files for every event using MxPEG codec. <i>Continuous Recording</i> continuously streams video data to stream files using MxPEG codec.
	Include audio	<b>Record Audio Data:</b> Store audio data in stream file if available. Enable and configure <a href="#">microphone</a> .
<b>Start Recording</b>	VM - Video Motion (VM2 - Video Motion 2) MI - Microphone SI - Signal Input (SI2 - Signal Input 2)	<b>Start Recording:</b> Select the events which will start recording. Use [Ctrl]-Click to select more than one event. Events in brackets need to be <a href="#">activated</a> first. <a href="#">EC</a> or <a href="#">EL</a> for filtered events.
	Max fps	<b>Event Frame Rate:</b> Recording speed if an event is detected, in frames per second.
	2 s	<b>Recording Time Before Event:</b> Additional recording time before an event stream.
	10 s	<b>Recording Time:</b> Time to include in recorded stream after an event has occurred.

- **Start Recording, Snap Shot Interval, Pre- and Post-Alarm Images:** Highlight the events in **Start Recording** that are supposed to start the recording process. **Snap Shot Interval** sets the time span between each of the pre- and post-alarm images that are to be recorded (maximum interval is 600,000 milliseconds = 10 minutes). The **Pre-** and **Post-Alarm Images** parameters set the number of images recorded before and after an alarm (event).

Make sure that the highlighted events are activated in the **Setup Menu > Event Settings** dialog if you intend to use them.

- **Retrigger Recording (optional):** Highlight the events, which should retrigger (i.e. extend) the recording time while the post-alarm images are stored.

If one of the selected events occurs, the camera extends the recording time by again storing the specified number of post-alarm images. This is an optional parameter.

Make sure that the highlighted events are activated in the **Setup Menu > Event Settings** dialog if you intend to use them.

- **Stop Recording, Images After Stop Event, Recording Dead Time (optional):** Highlight the events in **Stop Recording** that are supposed to stop an ongoing recording process. These parameters allow setting the number of images recorded after a **Stop Recording** event (**Images After Stop Event**,



max. 50) as well as the **Recording Dead Time**. The **Recording Dead Time** prevents new recordings after a **Stop Recording** event has been detected. The settings for **Stop Recording** are optional.

Note that the camera creates a new recording sequence if one of the events selected in **Start Recording** occurs.

Make sure that the highlighted events are activated in the **Setup Menu > Event Settings** dialog if you intend to use them.

- **Pack Event Story (optional):** In Snap Shot Recording mode, the MOBOTIX camera can also store the JPG images in a **packed** manner. All image files of one event sequence are stored "back to back" in one single file. If the camera stores one event with five pre- and five post-alarm images (plus the event image itself), it will have to conduct only two file operations (consisting of open, write, close) instead of eleven. This procedure drastically reduces the load on the server and the hard disk.

Note that you cannot view packed JPG images using standard graphics or image viewer applications; likewise, the MOBOTIX camera's Player cannot display packed images. The **Pack Event Story** setting is mostly used by applications, which have been designed for this special purpose.

### Typical Procedure of Snap Shot Recording

- The camera detects one of the events selected in **Start Recording**.
- The camera triggers the **Recording Begin (RB)** event.
- The **event number** is incremented by one.
- The camera stores the **pre-alarm images** (Annnnn.jpg).
- The camera stores the **event image** (Ennnnn.jpg).
- The camera stores the **post-alarm images** (Pnnnnn.jpg).
- The camera triggers the **Recording End (RE)** event.
- This completes the recording sequence.

Kamerasmodell	
X	-
X	-
-	X
-	X



Video sequences incl. audio



### 8.2.4 Settings of Event Recording

**Event Recording** can be used to record video clips in an event-controlled manner, including realtime sound from the camera microphone, if desired. Moreover, the camera can include a certain time before and after the event in the recording. The event frame rate can be set from one image every five seconds to a **maximum of 30 frames per second**. For playing back these video clips in **MxPEG format**, you can use the camera's Player screen (Internet Explorer on Windows required) or **MxViewer** for Windows.

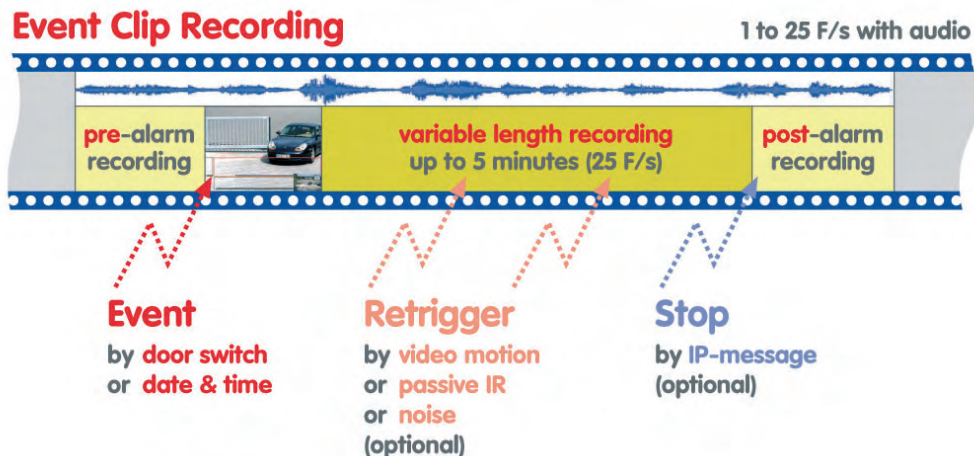

### Settings

Storage Settings	Value	Explanation
<b>Recording (REC)</b>	Event Recording	<b>Recording Mode:</b> Type of event and story recording. <i>Snapshot Recording:</i> stores single JPEG pictures. <i>Event Recording:</i> stores stream files for every event using MxPEG codec. <i>Continuous Recording:</i> continuously streams videodata to stream files using MxPEG codec.
	Include audio	<b>Record Audio Data:</b> Store audio data in stream file if available. Enable and configure <a href="#">microphone</a> .
<b>Start Recording</b>	All EC - Event Counter (EL - Event Logic) (EL2 - Event Logic 2)	<b>Start Recording:</b> Select the events which will start recording. Use [Ctrl]-Click to select more than one event. Events in brackets need to be <a href="#">activated</a> first. <a href="#">EC</a> or <a href="#">EL</a> for filtered events.
	Max fps	<b>Event Frame Rate:</b> Recording speed if an event is detected, in frames per second.
	2 s	<b>Recording Time Before Event:</b> Additional recording time before an event stream.
	10 s	<b>Recording Time:</b> Time to include in recorded stream after an event has occurred.

- **Audio:** If **Record Audio Data** has been set to **Include Audio**, the video clip will include the sound from the camera microphone.

Setup Menu >  
Recording >  
Event Recording

Realtime  
audio recording

- **Start Recording, Event Frame Rate, Recording Time:** Highlight the events in **Start Recording** that are supposed to start the recording process. The **Event Frame Rate** sets the frame rate for recording a video clip once an event has been detected. Set the **Recording Time** (max. five minutes) and the **Recording Time Before Event** (optional) as desired.

Make sure that the highlighted events are activated in the **Setup Menu > Event Settings** dialog if you intend to use them.

- **Retrigger Recording (optional):** Highlight the events that are supposed to extend an ongoing recording process. If one of the selected events occurs, the camera retriggers recording and continues to record video for the time specified in **Recording Time**. This is an optional parameter.

Make sure that the highlighted events are activated in the **Setup Menu > Event Settings** dialog if you intend to use them.

- **Stop Recording, Recording Time After Stop Event, Recording Dead Time (optional):** Highlight the events in **Stop Recording** that are supposed to stop an ongoing recording process. These parameters allow setting the time recorded after a **Stop Recording** event (**Recording Time After Stop Event**, max. 5 minutes) and the **Recording Dead Time**. The **Recording Dead Time** prevents new recordings after a **Stop Recording** event has been detected. The settings for **Stop Recording** are optional.

Note that the camera creates a new recording sequence if one of the events selected in **Start Recording** occurs.

Make sure that the highlighted events are activated in the **Setup Menu > Event Settings** dialog if you intend to use them.

### Typical Procedure of Event Recording

- The camera detects one of the events selected in **Start Recording**.
- The camera triggers the **Recording Begin (RB)** event.
- The **event number** is incremented by one.
- The camera stores the **event image** (Ennnnn.jpg).
- **MxPEG clip files** with the video and audio information are stored (Mnnnnn.jpg, with 10 seconds max. recording time each).
- The camera triggers the **Recording End (RE)** event.
- This completes the recording sequence.

Events, which have not been activated in **Setup Menu > Event Settings** are displayed "gray" and in parentheses



Frame rate will be increased if an event occurs

### 8.2.5 Settings of Continuous Recording

**Continuous Recording** can be used to permanently record video, including real-time sound from the camera microphone, if desired. Once the camera detects an event, it can automatically increase the frame rate (e.g. from one frame per second to max. 30 frames per second). This approach continuously stores the video and audio on as little space as possible but increases the frame rate during and after events to capture them with the best possible quality. For playing back these video clips in **MxPEG format**, you can use the camera's Player screen (Internet Explorer on Windows required) or **MxViewer** for Windows.



### Settings

Storage Settings	Value	Explanation
<b>Recording (REC)</b>	Event Recording	<b>Recording Mode:</b> Type of event and story recording. <i>Stop Shot Recording:</i> stores single JPEG pictures. <i>Event Recording:</i> stores stream files for every event using MxPEG codec. <i>Continuous Recording:</i> continuously streams video data to stream files using MxPEG codec.
	Include audio	<b>Record Audio Data:</b> Store audio data in stream file if available. Enable and configure <a href="#">microphone</a> .
<b>Start Recording</b>	VM - Video Motion (VM2 - Video Motion 2) MI - Microphone SI - Signal Input (SI2 - Signal Input 2)	<b>Start Recording:</b> Select the events which will start recording. Use [Ctrl]-Click to select more than one event. Events in brackets need to be <a href="#">activated</a> first. <a href="#">EC</a> or <a href="#">EL</a> for filtered events.
	Max fps	<b>Event Frame Rate:</b> Recording speed if an event is detected, in frames per second.
	2 s	<b>Recording Time Before Event:</b> Additional recording time before an event stream.
	10 s	<b>Recording Time:</b> Time to include in recorded stream after an event has occurred.

Setup Menu > Recording > Continuous Recording

Realtime audio recording

- **Audio:** If **Record Audio Data** has been set to **Include Audio**, the video clip will include the sound from the camera microphone.
- **Frame rate:** **Continuous Recording Frame Rate** controls the frame rate when no events are detected.

- **Start Recording, Event Frame Rate, Recording Time (optional):** Highlight the events in **Start Recording** that are supposed to increase the frame rate to the value set in **Event Frame Rate**. **Event Frame Rate** sets the frame rate for recording once an event has been detected. **Recording Time** specifies the duration during which the camera increases the frame rate. The settings for **Start Recording** and **Recording Time** are optional.

Make sure that the highlighted events are activated in the **Setup Menu > Event Settings** dialog if you intend to use them.

- **Retrigger Recording (optional):** Highlight the events, which should **retrigger (i.e. extend) recording** with increased frame rate. If one of the selected events occurs, the camera extends recording with increased frame rate for the time specified in **Recording Time**. This is an optional parameter.

Make sure that the highlighted events are activated in the **Setup Menu > Event Settings** dialog if you intend to use them.

- **Stop Recording, Recording Time After Stop Event, Recording Dead Time (optional):** Highlight the events, which should stop recording with increased frame rate and return to the default frame rate. These parameters allow setting the time recorded after a **Stop Recording** event (**Recording Time After Stop Event**, max. five minutes) and the **Recording Dead Time**. The **Recording Dead Time** prevents new recordings with increased frame rate after a **Stop Recording** event has been detected. Note that the camera creates a new recording sequence if one of the events selected in **Start Recording** occurs, but only if the specified **Recording Dead Time** has been observed. The settings for **Stop Recording** are optional.

Make sure that the highlighted events are activated in the **Setup Menu > Event Settings** dialog if you intend to use them.

Events, which have not been activated in **Setup Menu > Event Settings** are displayed "gray" and in parentheses

#### Note

The **Stop Recording** function will only stop recording with the frame rate set in Event Frame Rate. Recording itself will resume using the selected Continuous Recording frame rate.

The **Recording Begin (RB)** event will only be triggered if one of the events selected in **Start Recording** occurs. The **Recording End (RE)** event will be triggered if recording with increased Event Frame Rate switches back to the Continuous Recording frame rate.





History Recording is only available with Snap Shot and Event Recording

Setup Menu >  
Recording >  
**More** >  
History Recording

History images are ideal for web applications and for documenting construction sites, for example

### 8.2.6 Settings of History Recording

When using Snap Shot or Event Recording, **History Images** allow recording additional JPEG images at predefined times or at specific intervals.



You can choose between these **two types** of history images:

- **Use Time Task (TT):** Stores single JPEG images if the *Time Task (TT) event* has been activated in **Admin Menu > Time Tasks**. Make sure that the **Time Task Event (TT)** has been activated in the **Setup Menu > Event Settings** dialog.

Use this option to set up intervals of at least one minute (see also section 7.9, *Time Tasks*).

- **Use Periodic Event (PE):** Stores single JPEG images, if **Setup Menu > Event Settings > Periodic Event (PE)** has been activated.

Use this option to set up intervals from ten seconds to 24 hours (86,400 seconds). **Note that the camera software will automatically increase shorter intervals to ten seconds.**

#### Note

The **History Recording** function is similar to the periodic event or the Time Tasks in conjunction with the Time Task (TT) event. When recording events, the camera can store MxPEG video clips and JPEG images at the same time using the History Recording function.

Moreover, the History Recording feature can also store images, which have a different resolution, are using a different image sensor and have different texts and logos than the live image. Use the appropriate **Image** and **Logo Profiles** to control the image and logo parameters, respectively. For more information, see section 7.8.7, *Image Profiles*, and section 7.8.8, *Logo Profiles*.



## 8.3 Recording Types

### 8.3.1 Recording in the MOBOTIX Camera

When storing the recorded video in the internal ring buffer, the MOBOTIX camera can be used as stand-alone system. Recording requires neither extra storage media nor data cabling. As per factory default, this recording mode has already been activated.

Depending on the image size (resolution) and the quality, MOBOTIX Secure models can store up to **4,000 images in CIF resolution** (320x240), up to **2,500 images in VGA resolution** (640x480) and about **800 images in Megapixel resolution** (1280x960) in the internal ring buffer.

The **Playback screen** of the MOBOTIX camera allows viewing the events recorded in JPEG format. For playing back the video clips in **MxPEG format**, you can use Internet Explorer on Windows computers with installed **MxPEG ActiveX-Plug-in** or **MxViewer** for Windows.



Playback screen

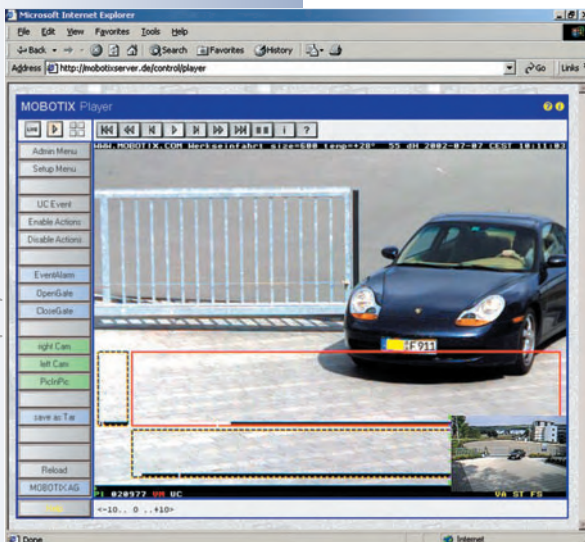

MOBOTIX camera playback screen



MxViewer

### Caution

Since the **internal image storage** of the MOBOTIX cameras is volatile, a power failure will delete all images and video clips that stored internally. Power should thus be supplied to the camera using an uninterruptible power supply (UPS). For security applications, it is highly recommended to set up recording on an external file server.

### Note

The following link shows the file system of the MOBOTIX camera. You can examine the file and folder structure as the camera creates it:  
**<http://<camera IP address>/record/events/>**

8.3.2 Recording on External File Servers

Using an external file server for recording requires configuring the camera and the file server. Open **Admin Menu > Event Storage on external file server** to configure the MOBOTIX camera.

To access the stored images or video/audio data later on, either open the **Player screen** of the camera (see section 4.4, *The Playback Screen in the Browser*) or use **MxViewer** and directly access the images on the shared directory of the external file server (see section 2.5.4, *MxViewer Options*, in the *MxViewer User Manual* on [www.mobotix.com](http://www.mobotix.com)).

Komponente	X	-
X	-	-
-	X	-
-	-	X

**Notes**

You can use **Linux/UNIX** computers, **Apple Mac OS X** computers (version 10.3 or higher) and **Windows** computers (from Windows 2000 Professional) without installing any software on these systems.

Regarding the hardware, a standard PC is sufficient for smaller applications. For larger systems, you should consider reliable quality server hardware.

**MXNFS Server** is a CD-based operating system by MOBOTIX, which converts a standard PC into a Linux file server in a couple of minutes. The cameras can use this server as external ring buffer storage.

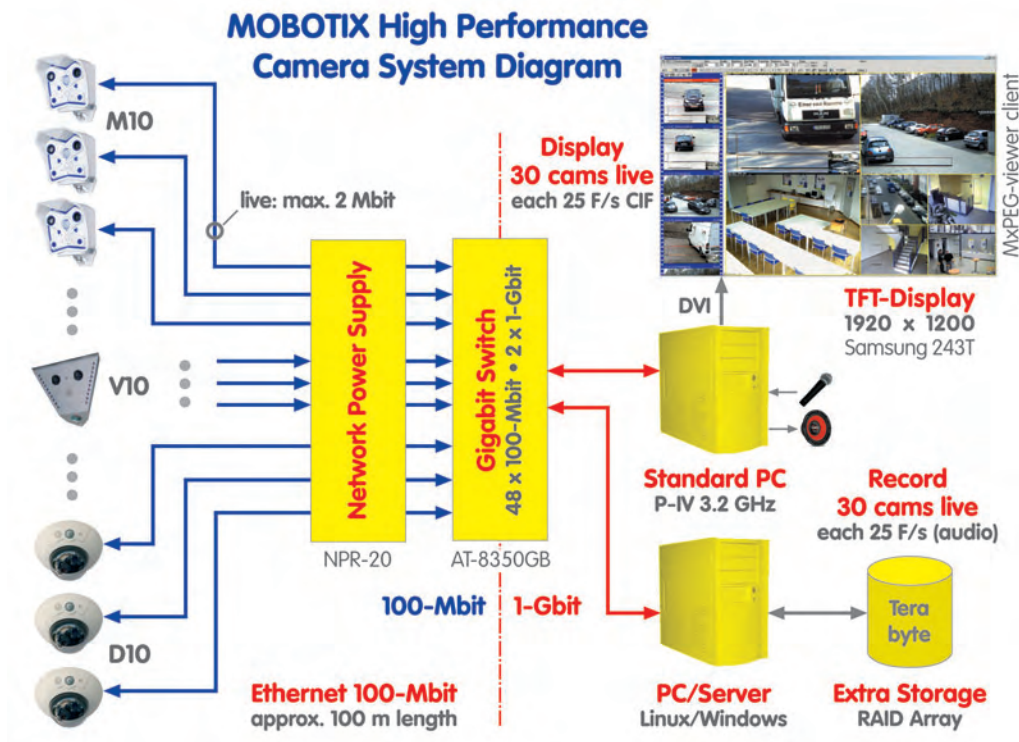

System architecture of external recording





### 8.3.3 Recording on a Windows Computer

#### Camera Settings

All required parameters for setting up the camera to record on a Windows computer are part of the **Admin Menu > Event Storage** dialog. When using Windows computers for recording, enter the appropriate settings in the **WIN** column of the dialog.



No additional software installation required!

**MOBOTIX M10 mx10-1-9-1 Event Storage**

**Internal Ring Buffer**

Internal Memory for Images: 64 MBytes  
Total size of internal memory used to store images.

Download  
Delete All

**External Event Image Storage**

External File Server:  Off  NFS  WIN (Hint) Status: //winserver/mxdata

File Server IP: 10.0.0.254 | 10.1.0.100  
IP address of server. Notes: - The server must be reachable via the network. - Set a local user on a Windows machine - domain and Active Directory logins will not work.

Remote Directory/Share: /data | mxdata  
Directory on the server to be mounted by the camera. Note: The server has to grant mounting rights to the camera.

Netbios name: winserver  
Netbios name of Windows computer. (This may be different from the DNS name!)

Username: mxcam  
Username of the camera account on Windows.

Password: mxcam  
Password of the camera account on Windows.

Storage Size: 512 MB  Unlimited | 1000 MB  Unlimited  
Maximum size in megabyte used to store remote event images. Calculate.

Time to keep:  Days  Unlimited |  Days  Unlimited  
Maximum time to keep remote events before removing.

Number of Events:   Unlimited |   Unlimited  
Maximum number of events stored remotely.

Set Factory Restore Close More

Set to Unlimited time

Set to Unlimited number

The following parameters contain the settings required by the camera to use a shared folder on the Windows computer (see also **Settings on the Windows Server**). The essential information to enter is mostly found using the `ipconfig` or `ipconfig /all` command at the command line (`cmd`) of the Windows computer (the Netbios name can also be found on the **Start > Control Panel > System > Computer Name** tab).

- **External File Server:** Activate the **WIN** option if you intend to use a Windows computer as external ring buffer.
- **File Server IP:** Enter the Windows server's IP address in this field (e.g. `10.1.0.100`). You can also use the DNS name of the computer, if this name has been registered within the local network. (**Caution:** The DNS name *does not have to match* the Netbios name of the Windows computer!).

**Notes**

The MOBOTIX cameras use **local accounts** on the Windows computer. **Domain or Active Directory logins are not supported.**

Windows Professional operating systems limit the number of cameras recording on one PC to a maximum of eight cameras (max. eight simultaneous TCP/IP connections). This limitation is not present on Windows Server products.

Windows 95, 98, Millennium and products of the Windows "Home" family are not supported and **must not be used**. We recommend **Windows 2000 Professional, Windows XP Professional** or higher (or the corresponding server versions of these operating systems).

Make sure that a proper DNS server has been set in **Admin Menu > Ethernet Interface**.

- **Share:** Enter the name of the Windows share in this field (e.g. *mxdata*).
- **Netbios name:** Enter the Windows server's Netbios name in this field (e.g. *winserver*).
- **User Name:** Enter the name of the local user in this field who has been granted access to the Windows share. This is the user name used by the camera when logging onto the Windows computer (e.g. *mxcam*).
- **Password:** Enter the password of the local user in this field who has been granted access to the Windows share. This is the password used by the camera when logging onto the Windows computer (e.g. *mxcam*).

**Caution**

The camera will only start recording on the Windows system if you click the **Set** button to apply the settings, **Close** the dialog, store the configuration and reboot the camera. Likewise, changed settings will only be applied after the camera has been rebooted.

Procedure!

**Caution: Set up the Windows firewall**

Restart the camera to apply the changes!

The following settings allow setting limits to the **storage size**, the **time for keeping the images** and the **maximum number of events** to store on the Windows computer.

It is usually sufficient to set the maximum storage size used by the camera on the Windows computer. Only special applications require specifying the maximum time to keep the images and the maximum number of events.

- **Storage Size:** Enter the maximum size (MB) the camera will use on the Windows computer in this field. The factory default setting is *512 MB*.

When reaching the maximum storage size, the MOBOTIX camera will automatically delete the oldest files. **Caution:** The setting *Unlimited* will create an error once the storage capacity has been reached.

- **Time to keep:** Enter the maximum time (in days) in this field, for which the camera should keep the images on the Windows computer before deleting them. The factory default setting is *Unlimited*.

The MOBOTIX camera will automatically delete all images, which are older than the maximum number of days specified.

- **Number of Events:** Enter the maximum number of events to store on the Windows computer in this field. The factory default setting for this setting is *Unlimited*.

When reaching the maximum number of events, the MOBOTIX camera will automatically delete the oldest events.

### External Logging

Click on the **More** button to see the options for external logging.

Storing the camera's log files can help track down errors and can be used to monitor the camera's actions. You could check the camera's system messages to see if the connection to the server has been disrupted, for example. The web server log file on the other hand automatically logs all users and when they accessed the camera.

- **Event Storage:** When activating the event storage log file, the camera will periodically store this file on the Windows computer. This log file allows setting a maximum size (default is 128 kB).
- **Camera Logfiles:** When you activate this option, the camera will store the web server log file (`WebServerMessages.log`, **Admin Menu > Web Server Logfile**) and the system messages (`SystemMessages.log`, **Admin Menu > System messages**) at regular intervals on the Windows computer.

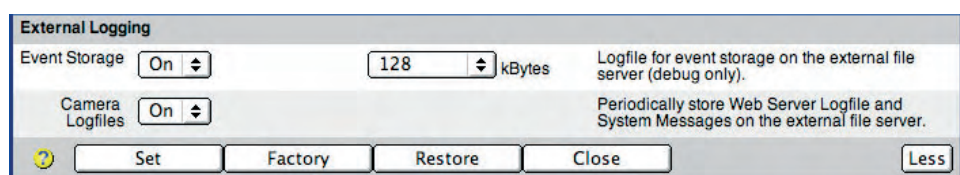

Server Settings (Windows Computer)

Note

Make sure that the latest service packs and security patches have been applied to the Windows file server. Some older Windows server versions can only store a maximum of about 800,000 events. This error in the operating system has been fixed with the current service packs.

- **Step 1:** Log onto the Windows computer with administrator rights.
  - **Step 2:** Create a new *local* user and set a password (e.g. mxcam). The camera will use this user name later on to log onto the Windows computer.
- Open **Start > Run** and enter `lusrmgr.msc`. Click on **OK** to open the **Windows Management Console** for managing local users (see also **Control Panel > Management > Computer Management > Local Users and Groups**).

Procedure

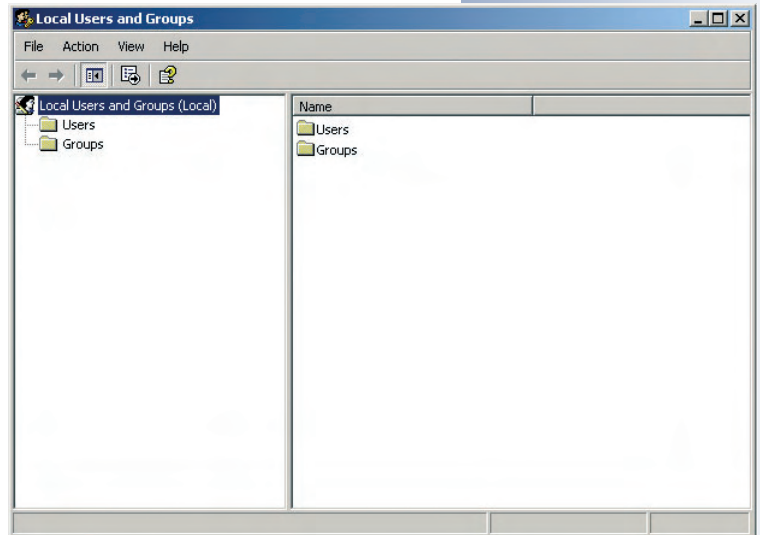

- Select the **User** item in the left panel.
- Click on **Action > New User**.

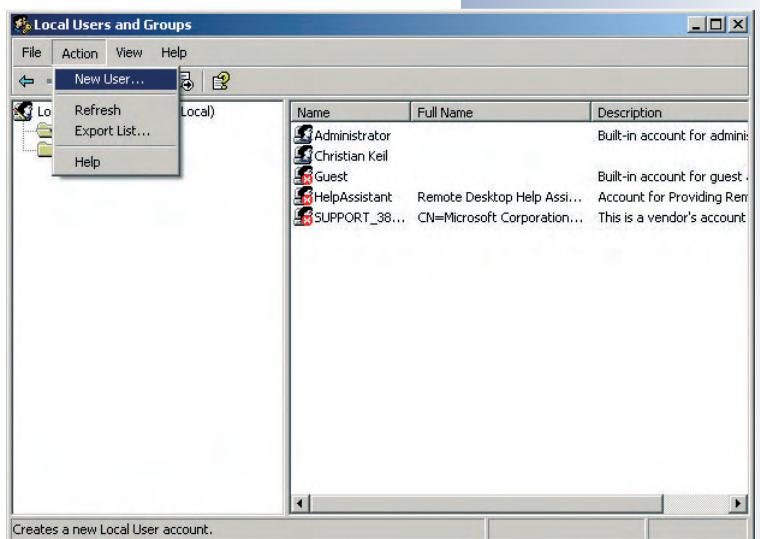



- Enter a new user name (e.g. mxcam).
- Set a **Password** (e.g. mxcam) and enter the same password in **Confirm password**.
- Deactivate the **User must change password at next logon** checkbox.
- Activate the **Password never expires** option.

**Caution: Enter exactly the same user name (mxcam)**

**and password (e.g. mxcam) in the camera dialog!**

**Activate**

**Activate the "Password never expires" option**

Disable the "Use simple file sharing" option

- **Step 3:** Make sure that **Simple file sharing** is not used:
  - Open **Start > Control Panel > Folder Options > View** (tab).
  - Deactivate the **Use simple file sharing** option (recommended, if present).
  - Close the dialog by clicking on **OK**.
- **Step 4:** Create a new folder with a name of your choice (e.g. mxdata).

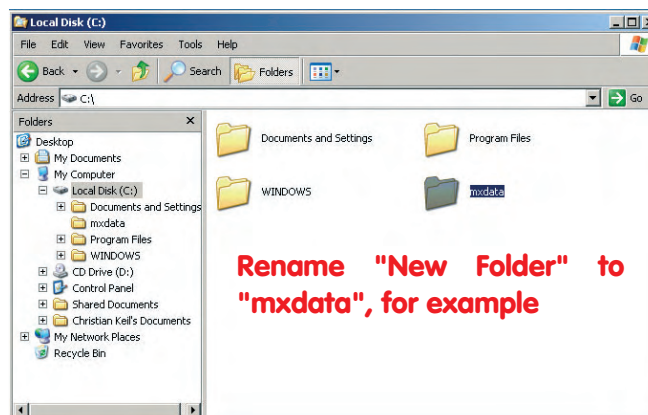

- **Step 5:** Right-click on the folder you just created. Select the **Sharing and Security** (Windows XP) or the **Share** (Windows 2000) option from the context menu.
- **Step 6:** Activate **Share this folder**. Enter a share name (e.g. mxdata).

Enter exactly the same share name in the camera dialog!

Next, click on "Permissions"!

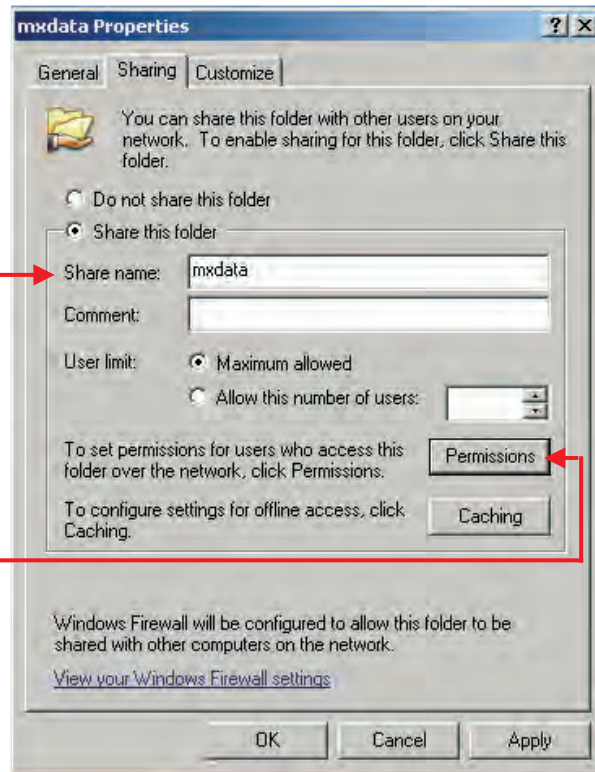

Enter this share name in the camera dialog in the **Remote Directory/Share** field

- **Step 7:** Click on **Permissions**. Add the user name of the account you just created.
- **Step 8:** Change the access rights for this user by activating the **Full Control** option in the **Allow** column.
- **Step 9:** Close all dialogs by clicking on **OK**.

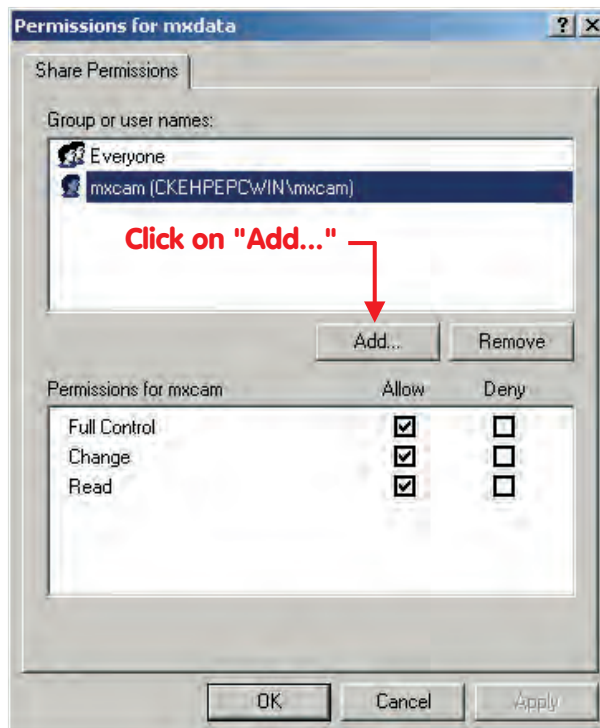

Activate permissions (Full control, Change, Read)



### 8.3.4 Recording on a Linux/UNIX Computer

#### Camera Settings

All required parameters for setting up the camera to record on a Linux/UNIX computer are part of the **Admin Menu > Event Storage** dialog. When using Linux/UNIX computers for recording, enter the appropriate settings in the **NFS** column of the dialog.



No additional software installation required!

No time limit

No number limit

The camera requires the following parameters for managing its own folder on the Linux/UNIX computer (click **More** at the bottom of the dialog to see all options), i.e. user number (UID) and group number (GID); see also **Settings on the Linux/UNIX Server**.

Open a terminal of the Linux/UNIX computer to obtain the required information. Note that this procedure requires some knowledge of Linux/UNIX operating systems.

- **External File Server:** Activate the **NFS** option if you intend to use a Linux/UNIX computer as external storage.

- **File Server IP:** Enter the Linux/UNIX server's IP address. You can also use the DNS name of the computer, provided its name has been registered within the local network. (**Caution:** The DNS name *does not have to* match the host name of the Linux/UNIX computer!)

Make sure that a proper DNS server has been set in **Admin Menu > Ethernet Interface**.

- **Directory:** Enter the name of the directory (on the Linux/UNIX computer) in this field, which should be used by the MOBOTIX camera for recording.
- **Netbios name, User name, Password:** These settings are only required when recording on Windows or Mac OS X computers using SMB.
- **User ID and Group ID (UID and GID):** If required, you can enter the user and group numbers for the NFS server. The camera will use the user ID and group ID on the Linux/UNIX computer when recording.

#### Caution

The camera will only start recording on the Linux/UNIX system if you click the **Set** button to apply the settings, **Close** the dialog, store the configuration and reboot the camera. Likewise, changed settings will only be applied after the camera has been rebooted.

The following settings allow setting limits to the **storage size**, the **time for keeping the images** and the **maximum number of events** to store on the Linux/UNIX computer.

It is usually sufficient to set the maximum storage size used by the camera on the Linux/UNIX computer. Only special applications require specifying the maximum time to keep the images and the maximum number of events.

- **Storage Size:** Enter the maximum size (MB) the camera will use on the Linux/UNIX computer in this field. The factory default setting is *512 MB*.

When reaching the maximum storage size, the MOBOTIX camera will automatically delete the oldest files. **Caution:** The setting *Unlimited* will create an error once the storage capacity has been reached.

- **Time to keep:** Enter the maximum time to keep the images (in days) in this field, for which the camera should keep the images on the Linux/UNIX computer before deleting them. The factory default setting is *Unlimited*.

The MOBOTIX camera will automatically delete all images, which are older than the maximum number of days specified.

- **Number of Events:** Enter the maximum number of events to store on the Linux/UNIX computer in this field. The factory default setting for this setting is *Unlimited*.

When reaching the maximum number of events, the MOBOTIX camera will automatically delete the oldest events.

Restart the camera to apply the changes!



### External Logging

Click on the **More** button to see the options for external logging.

Storing the camera's log files can help track down errors and can be used to monitor the camera's actions. You could check the camera's system messages to see if the connection to the server has been disrupted, for example. The web server log file on the other hand automatically logs all users and when they accessed the camera.

- **Event Storage:** When activating the event storage log file, the camera will periodically store this file on the Linux/UNIX computer. This log file allows setting a maximum size (default is 128 kB).
- **Camera Logfiles:** When you activate this option, the camera will store the web server log file (`WebServerMessages.log`; **Admin Menu > Web Server Logfile**) and the system messages (`SystemMessages.log`; **Admin Menu > System messages**) at regular intervals on the Linux/UNIX computer.

The screenshot shows a configuration window titled "External Logging". It contains two rows of settings. The first row is for "Event Storage", which is set to "On" and has a size of "128 kBytes". A help text next to it says "Logfile for event storage on the external file server (debug only)". The second row is for "Camera Logfiles", which is also set to "On". A help text next to it says "Periodically store Web Server Logfile and System Messages on the external file server." At the bottom of the window, there are five buttons: "Set", "Factory", "Restore", "Close", and "Less".

**Server Settings (Linux/UNIX Computer)**

- **Step 1:** Log onto the Linux/UNIX computer with **root** rights.
- **Step 2:** Create a new directory with a name of your choice (e.g. mxdata):  
`mkdir /mxdata.`
- **Step 3:** Change the owner and the user group for this directory (e.g. 65534:nobody and 0:nogroup):  
`chown -R 65534:0 /mxdata.`
- **Step 4:** Assign the required access rights for the directory:  
`chmod 755 /mxdata.`
- **Step 5:** Use the `ps aux | grep nfs` command to check if the NFS server is already running. If this is not the case, use the `/etc/init.d/nfsserver start` command to start the service, or install the service from scratch if it is not available.
- **Step 6:** Use the `rpcinfo -p` command to check if the *nfs*, *mountd* and *portmapper* services are executed. Normally, *nfs* and *mountd* are started by the NFS server while *portmapper* is running as a separate service. If *portmapper* is not running, you can start it using the `/etc/init.d/portmapper start` command.
- **Step 7:** Open the `/etc/exports` file in a text editor and add the following line:  
`/mxdata <camera IP address> (rw,no_root_squash)`, e.g.  
`/mxdata 10.1.0.99 (rw,no_root_squash)`
- **Step 8:** To re-initialize the list of entries in `/etc/exports`, execute the `exportfs -a` command.
- **Step 9:** Next, restart the NFS server. Execute the following command:  
`/etc/init.d/nfsserver restart.`

This completes the configuration of the Linux/UNIX server.

**Note**

**MXNFS Server** is a CD-based operating system by MOBOTIX, which converts a standard PC into a Linux file server in a couple of minutes. The cameras can use this server as external ring buffer storage.





Set the Windows configuration options on the camera!

No additional software installation required!

### 8.3.5 Recording on a Mac OS X Computer

#### Camera Settings

All required parameters for setting up the camera to record on a Mac OS X computer with activated Windows Sharing are part of the **Admin Menu > Event Storage** dialog. The configuration of the MOBOTIX camera is not any different from the procedure described in section 8.3.3, *Recording on a Windows Computer*.



#### Server Settings (Mac OS X Computer)

- **Step 1:** Log onto the Mac OS X computer with administrator rights.
- **Step 2:** Create a new standard user, set a password (e.g. mxcam/mxcam). The camera will use this user name later on to log onto the Mac OS X computer. Note that the new user does not require administrator rights (deactivate **System Preferences > Accounts > Password > Allow user to administer this computer**).

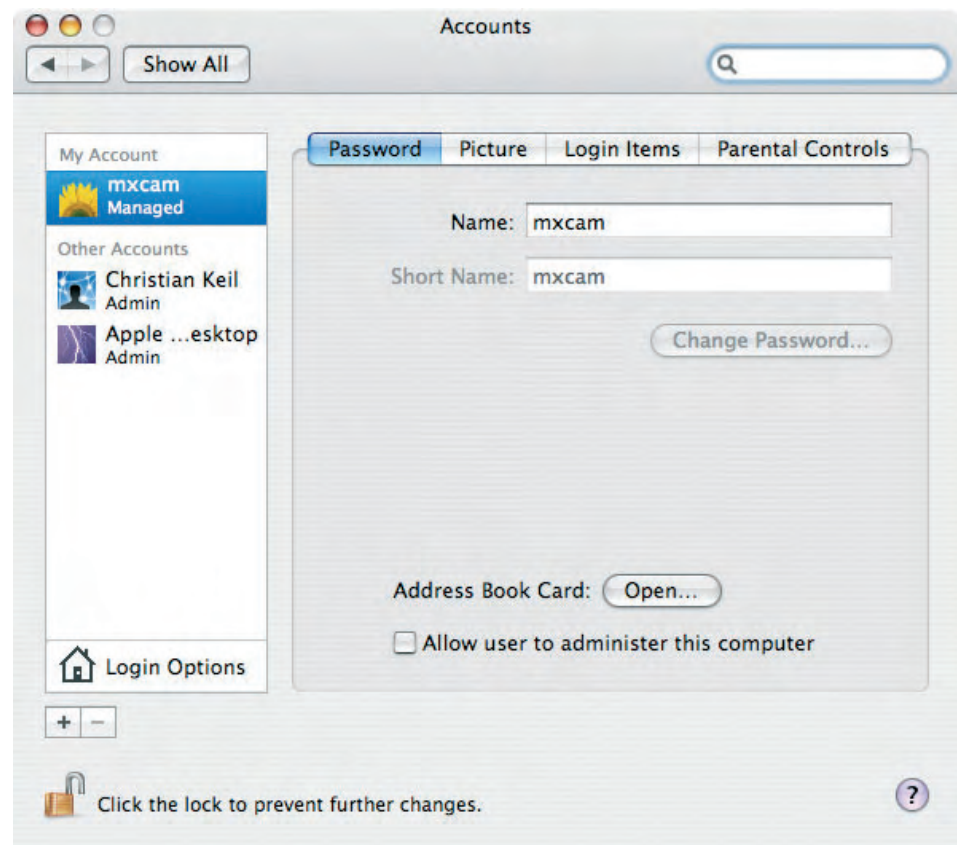

- **Step 3:** Open **System Preferences > Sharing** and activate the *Windows Sharing* option.

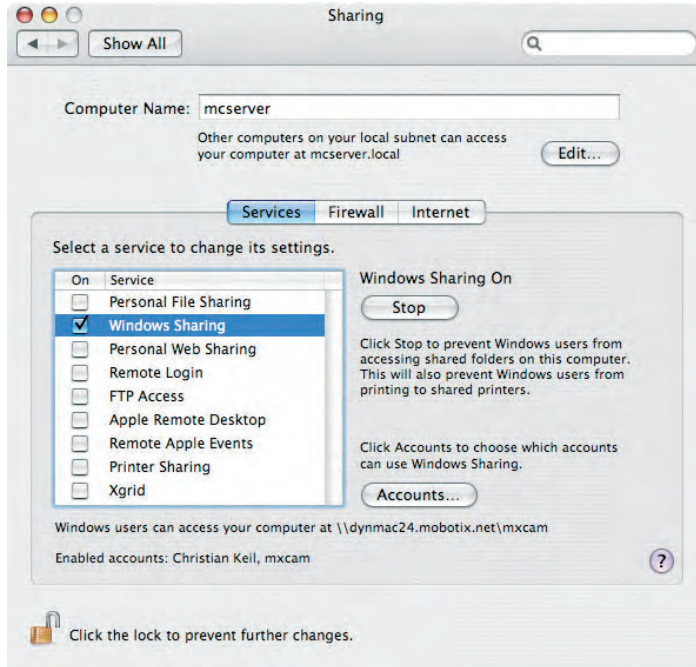

Caution: From OS X version 10.4, you also have to specify the account, which may use Windows sharing (mxcam in the example). A warning and a dialog box will appear automatically.

- **Step 4:** In the Finder, create a new folder with a name of your choice (e.g. mxdata).
- **Step 5:** Install **SharePoints** ([www.hornware.com](http://www.hornware.com), donationware) and create a share point for the folder (mxdata) and the user (mxcam) you just created:

**SharePoints > SMB Properties > General Properties:**

- **Server Netbios Name:** Enter the computer name of the Mac OS X computer in this field (e.g. mcserver). To find the computer name of the Mac OS X computer, open **System Properties > Sharing**.

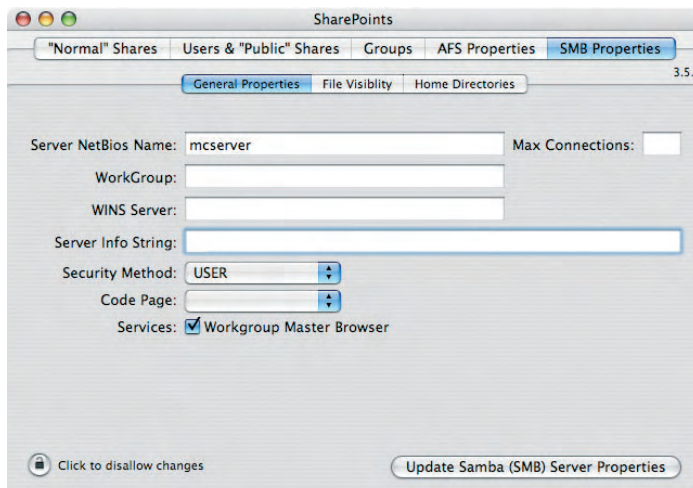

Install the donationware application SharePoints ([www.hornware.com](http://www.hornware.com))

Do not forget to make a donation when using SharePoints



Activate Shared check-box!

### SharePoints > SMB Properties > Home Directories:

- Make sure that the **Shared** option has been activated.
- Click on the **Activate Samba (SMB) Server Properties** or the **Update Samba (SMB) Settings** button, whichever is appropriate.

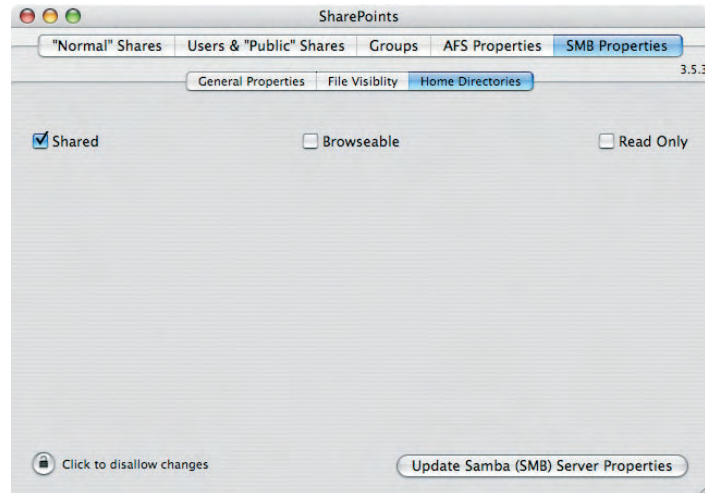

### SharePoints > "Normal" Shares:

- In the **Directory** field, enter the name of the **shared folder** (e.g. /mxdata).
- Enter a **Share Name** (e.g. mxdata).
- Make sure that the correct **owner and group** have been set in **Show File System Properties** (mxcam in this case).

Configure Share!

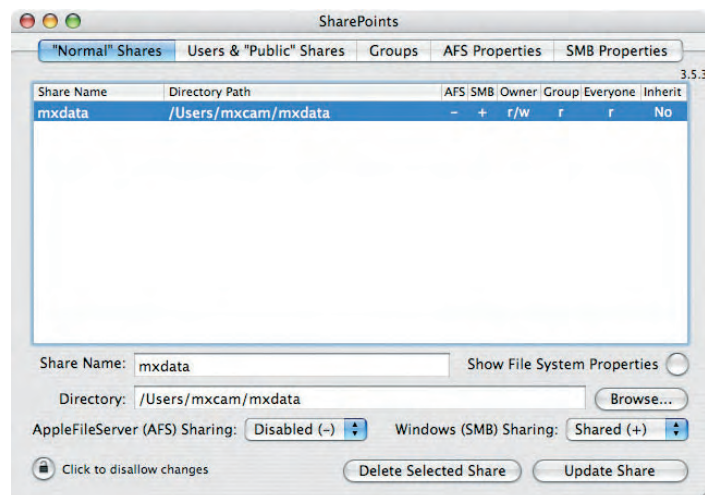

- Activate **Windows (SMB) Sharing: Shared (+)**.
- Click on the **Create New Share** or the **Update Share** button, whichever is appropriate.

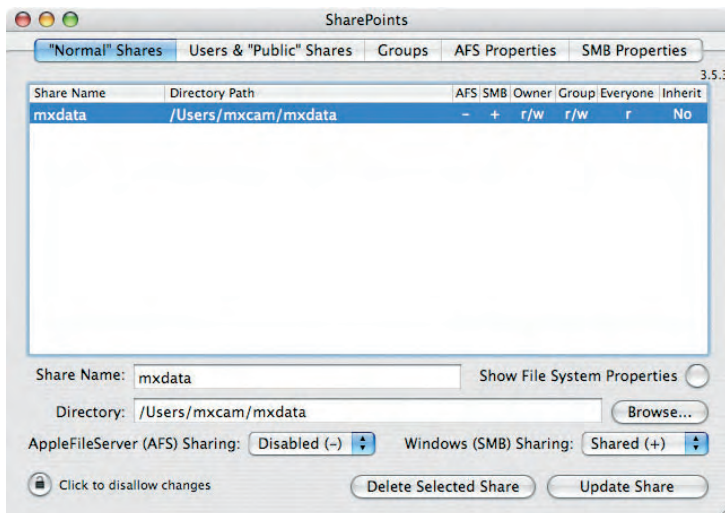

Activate Share!

- **Step 6:** Close SharePoints and the System Properties. Log out the current user (**Apple > Log Out mxcam**). For recording on the Mac OS X computer, it is not necessary that a user is logged in. Likewise, rebooting the Mac OS X computer is not required.

### Notes

Make sure that the latest software updates and security patches have been applied to the Mac OS X file server. The operating system should be **Mac OS X 10.3 or higher**.

Using **SharePoints** ([www.hornware.com](http://www.hornware.com)) for managing the shares is not required, but this application will greatly facilitate setting up the shares.

### 8.3.6 Notes on the Storage Folder Structure

The MOBOTIX camera will automatically create a folder structure based on its factory IP address and the event number.

Click the Player button again to get information on the status of the **external storage on the file server**

MOBOTIX M10 Werkseinfahrt Camera List							
Source	Date from	Date to	Sequences	Images	Usage [Mbytes]	Limits	
Internal Recorder	2006-05-23 10:48:07	2006-05-23 13:31:59	105	2042	57 of 64		
Werkseinfahrt	2006-05-17 12:53:43	2006-05-23 13:31:59	1521	32148	961 of 1024		
Steve-TV	2006-03-27 19:09:46	2006-05-23 13:32:31	16648	203187	10238 of 10240		
ROTOR3	2006-05-22 19:24:00	2006-05-23 13:32:00	1089	8694	2004 of 2048	7 days	
Einfahrt-mega	2006-05-23 08:07:33	2006-05-23 13:32:21	347	1567	500 of 512	7 days	
d10	2006-05-23 09:10:00	2006-05-23 13:32:00	259	2057	1984 of 2048	7 days	
empfang-V10	2006-05-23 04:27:00	2006-05-23 13:32:00	545	4362	488 of 512	7 days	
ZaunNight	2006-01-23 08:21:55	2006-05-23 13:30:02	5756	11348	509 of 512		
jvasieg2	2005-11-30 16:38:55	2005-12-05 16:41:21	3849	12366	4047 of 4098		
jvasieg2	2006-02-18 07:33:05	2006-05-23 11:15:57	2604	9737	4038 of 4098		
Total Usage					24769 of 25092		
Free Space on File Server					110592		

A camera with the factory IP address **10.1.0.99**, for example, would create the following folder structure for event number **001798**:

**folder structure: 10\_1\_0\_99/record/events/001/798/E00000.jpg**

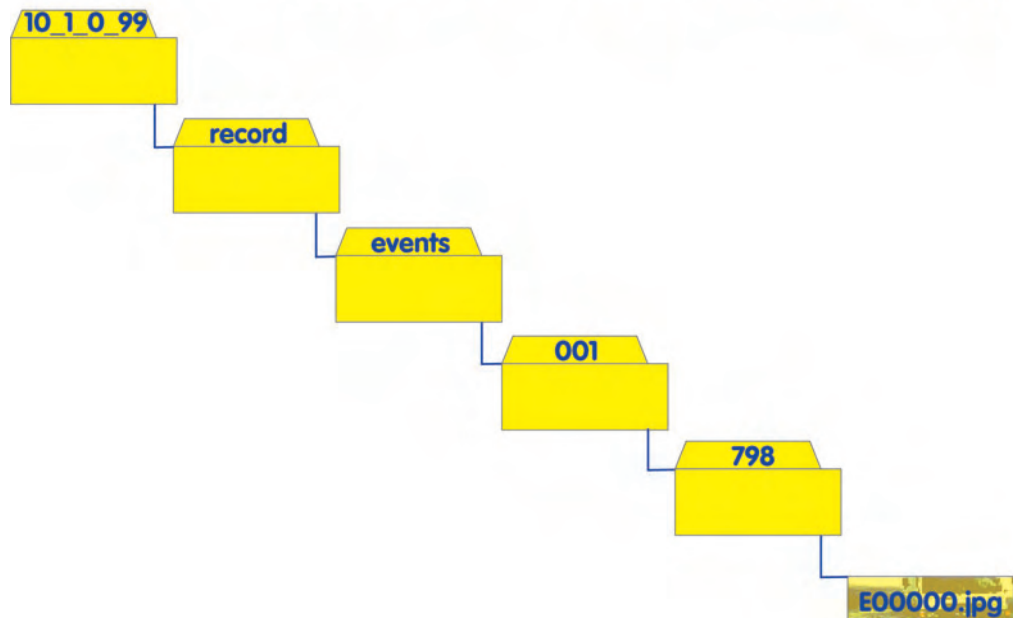

**Path and folder names on the camera and on the file server**

- **Internal camera storage:**  
<http://10.1.0.99/record/events/001/798/E00000.jpg>

Folder structure for camera with IP address: 10.1.0.99

- **Windows File Server:**  
\\<Netbios Name>\<Share>\10\_1\_0\_99\001\798\E00000.jpg
- **Linux/UNIX File Server:**  
<DNS-Name>/<Directory>/10\_1\_0\_99/001/798/E00000.jpg

The **file names** of the recorded images and video clips are created using the following patterns:

- **Ennnnn.jpg:** Event Images
- **Annnnn.jpg:** Pre-alarm (**A**n**t**e) images
- **Pnnnnn.jpg:** Post-alarm images
- **Cnnnnn.jpg:** Packed (**C**ontinuous) single images
- **Mnnnnn.jpg:** **M**xPEG video clip files
- **INFO.jpg:** Only contains the JPEG header information of the event image and the image sequence; this file is created in every folder.

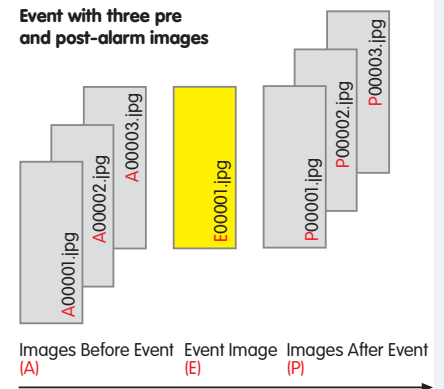

#### Note

The camera will also store files with **.log** and **.txt** extensions as well as the **.erdinfo** file. These files contain important video management information of the corresponding MOBOTIX camera and must not be touched. This applies especially to the **.erdinfo** file.

Additional information

#### Caution

**Manipulating the file structure of the MOBOTIX camera can lead to problems when recording; the camera may even display erratic behavior and may stop recording altogether. Never manipulate the file structure!**

You should **never remove nor rename folders or files**. Likewise, opening the files from other applications is only feasible if the MOBOTIX camera will not access the image and video files at the same time. For example, the MOBOTIX camera cannot delete a file or a folder if this file or folder has been opened by another application.

**Copying files and folder, however, represents a workable alternative. You can access the copied files and folders without any restrictions.**



## 9 TELEPHONY FEATURES

### 9.1 Overview

The telephony features of the MOBOTIX camera allow using the camera like a phone with optional video features. The camera can thus transmit audio and video data from and to a phone or a softphone, i.e. telephone software running on a PC or PDA.

To be able to do this, the MOBOTIX camera can use both **ISDN** and **network connections** (**IP telephony** is using the **SIP** protocol). When placing phone calls, the camera can call a standard analog connection, a mobile (cell) phone, an IP phone, a softphone or another MOBOTIX camera.

Direct SIP telephony using static IP addresses

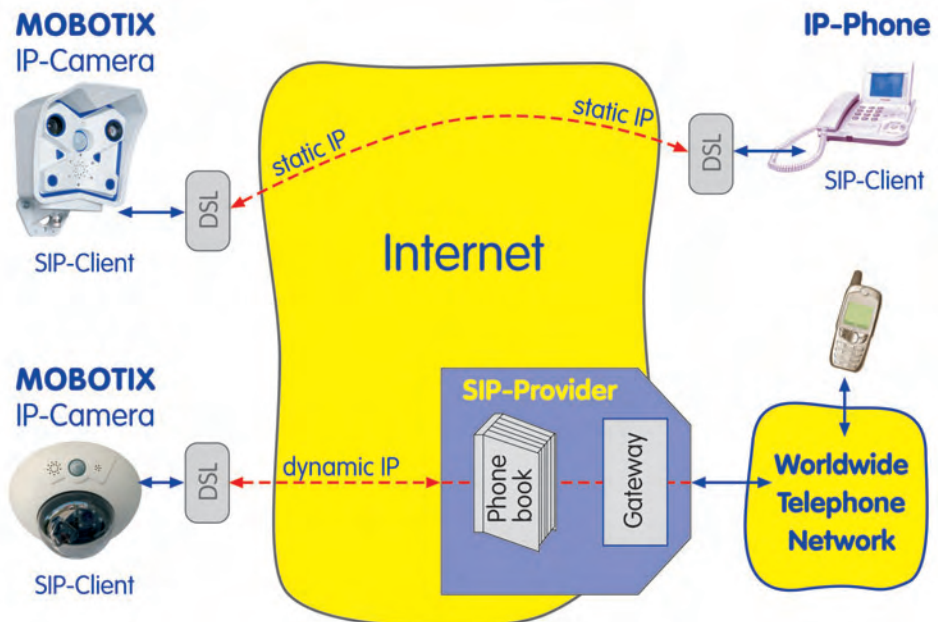

SIP telephony using SIP provider

In case of an **alarm**, for instance, the MOBOTIX camera can call you on the phone and can play back a voice message. Afterwards, you can listen to what the camera microphone is "hearing", make an announcement over the camera's built-in speaker or use the camera as an intercom system.

Likewise, you can call the MOBOTIX camera from a phone and use the same audio features (listen to the audio channel from the camera microphone, make an announcement over the camera speaker or use it as an intercom system).

In addition, you can use an existing connection to execute remote-control functions with the phone's touchtone keys. For instance, you can send the last event image to the preset e-mail address by pressing a key on your phone.

#### IP Telephony Using the Network (LAN/Ethernet/Internet)

To date, the communication systems of private households and companies are usually based on **two separate infrastructures**: a **phone network** (telephone sys-

tem) and a **data network**. In contrast, IP telephony allows **making phone calls using the existing data network infrastructure** (LAN/Ethernet/Internet). Quality of speech and required bandwidth when making IP phone calls is similar to using an ISDN connection.

### Advantages of IP Telephony

- Only requires **one network infrastructure** (LAN/Ethernet/Internet), which is already in place.
- **Relatively simple and inexpensive implementation**; maintenance by existing IT staff; **not much additional knowledge** required.
- **Inexpensive phone calls when calling fixed-line or mobile (cell) phones**, especially when making long-distance calls; **free calls when calling other IP phones on the LAN or the Internet**.
- **Common standard worldwide (SIP)**.

### Supported Standards

MOBOTIX already supports all common telephone technologies and has implemented the SIP standard, the most important IP telephony protocol.

MOBOTIX cameras support **video telephony** and **video conferencing**, e.g. when using instant messaging applications (Microsoft Messenger, etc.), softphones (XLite/Eyeball, WenGo, etc.) and video phones.

### Additional Information

If you **would like to call your MOBOTIX camera without much further ado**, read section 9.3, *Camera Phone (Listen, Speak and Intercom Modes)*.

Use the following dialogs to configure the features for ISDN and IP telephony:

- **Admin Menu > VoIP Settings** (section 9.2)
- **Admin Menu > Camera Phone** (section 9.3)
- **Admin Menu > Phone Profiles** (section 9.4)
- **Admin Menu > Phone Call-In** (section 9.5)

The sections 9.7, *Sample Configurations for IP Telephony via Internet* and 9.8, *Sample Configurations for IP Telephony via LAN* contain examples of how to configure the telephony settings.

If you do not have any experience with IP telephony, it is recommended to read and try out the example in section 9.8, *Sample Configurations for IP Telephony via LAN*.

#### Note

Note that both the microphone and the speaker should be activated when using the telephony features (**Admin Menu > Loudspeaker and Microphone**). **By factory default, the microphone is disabled!**

MOBOTIX cameras support SIP, the most common standard worldwide

If you would like to use an ISDN phone connection, you can skip section 9.2

## 9.2 VoIP Settings for IP Telephony

In order to use IP telephony, the MOBOTIX camera has to be connected to a LAN or a DSL router with an Internet connection. In addition, the camera needs to be properly configured according to the access data from your SIP provider. Registering with a SIP provider is usually done on the website of the provider (find a list of providers on sipcenter.com, for example). As a general rule, you should get the access data on the provider's website itself or within minutes by e-mail.

Open **Admin Menu > VoIP Settings** to configure the MOBOTIX camera for using its IP telephony features. **A successful VoIP configuration is required for using the Camera Phone, the Phone Profiles (outbound voice calls of the camera) and the Dial-In Connection via IP telephony.**

Click on the **VoIP Messages and Call Log** link at the bottom of the dialog to get **information and status messages of the SIP connection**. Use this dialog to check if logging into the SIP provider has worked properly. For additional information on this topic, see chapter 12, *Troubleshooting*.

### VoIP Settings

- **VoIP:** This is the "main switch" of the IP telephony features of the MOBOTIX camera.

Open **VoIP Settings** to configure the camera's SIP client

General Phone Settings	
VoIP:	Enabled
Enable or disable Voice over IP. This software currently supports the SIP protocol. A valid SIP user address looks like this: <user name>@<domain>, e.g. sipphone@provider.com.	
SIP Settings	
User Name:	<sip user name>
The <i>user name</i> part of the camera's SIP address (the part to the left of the '@' character) or login name for the SIP provider (in case they are not the same).	
SIP Domain:	sipgate.com
The <i>domain</i> part of the camera's SIP address (the part to the right of the '@' character).	
Registrar:	sip.sipgate.com
Registration server to register the camera's IP address with. Registration servers map SIP addresses to IP addresses. Leave empty to deactivate registration.	
Registration User Name:	<sip registration user name>
User name for registration at your SIP provider (usually the same as your user name).	
Registration Password:	<sip registration user pass>
Password for registration at your SIP provider.	
Use as Outbound Proxy:	Enabled
The registrar is used as the default SIP proxy for all outgoing calls.	
Registration Expires After:	1 min.
The registration expires after this time and is refreshed automatically.	

### Note

Using IP telephony **only with devices on the LAN** is a special case. This test scenario is valuable to gather experience with IP telephony, since it **does not require Internet access** or a **SIP provider**.

## SIP Settings

### • Standard case: with SIP provider

- **User Name:** Enter the SIP user name that you have registered or that you have been assigned during the registration process with your SIP provider. Currently, this entry is identical to the Registration User Name (see below). For certain scenarios, however, they could be different.
- **SIP Domain:** Enter the IP address or the name of the SIP provider (e.g. **sipgate.com**).
- **Registration Server:** Enter the IP address of the SIP server for the camera to log onto as SIP user, e.g. **sip:sipgate.com**.
- **Registration User Name:** Enter the login name registered with the SIP provider. Currently, this entry is identical to the registration user name (see above) for most of the SIP providers. For certain scenarios, however, they could be different.
- **Registration Password:** Enter the correct password for the Registration User Name.
- **Use as Outbound Proxy:** If this option is enabled, the MOBOTIX camera uses the registration server as default SIP proxy for all outgoing SIP connections. This parameter should be enabled.
- **Registration Expires After:** After the time set for this parameter, the MOBOTIX camera will login again at the registration server. You should not have to change this setting (default is *1 Min.*).

### • Special case: IP telephony on the network (no SIP provider required)

- **User Name:** Enter a user name which is used for calling the camera. This user name can be set freely.
- **SIP Domain:** Enter the IP address of your MOBOTIX camera.

It is not necessary to enter any other data in this dialog!

## Network Settings

The SIP network settings should only be changed if your network environment uses special security mechanisms (firewall, NAT routers, etc.). Contact your network administrator to obtain the required information.

Network Settings	
Use Router Address: <input type="button" value="Disabled"/>	Enable or disable using the IP address of a router with NAT (Network Address Translation) instead of the camera's IP address.
Router Address: <input type="text"/>	The DNS or IP address of the router using NAT.
Router Address Refresh Time: <input type="button" value="1 min."/>	The camera will update the router address after this time.
SIP Port: <input type="text" value="5060"/>	Port to use for the SIP protocol.
Audio RTP Port: <input type="text" value="7078"/>	Port to use for transmitting the audio data using the RTP protocol.
Audio Data Timeout: <input type="button" value="3 sec."/>	The camera hangs up the call if there is no incoming audio data for this time.

The MOBOTIX camera can now be reached using the SIP address (e.g. **firstname.lastname@< sip\_provider>**) or the phone number assigned by your SIP provider

Assuming the user name **mxcam** and the SIP-Domain **10.1.0.99**, the MOBOTIX camera can be reached using this SIP address: **mxcam@10.1.0.99**



- **SIP Port:** Enter the SIP port that is to be used e.g. behind a firewall. Only change the standard port 5060 if this is absolutely necessary.
- **Audio RTP Port:** This is the port that is used for transferring the audio data. You may need to change this setting for some SIP providers or firewall scenarios. If a router or firewall is used that performs NAT (Network Address Translation), the router/firewall will have to redirect this port to the camera if direct SIP connections (without SIP provider) are to be used.
- **Use Router Address:** Activate this option if you are establishing connections via a router or firewall that performs NAT.
- **Router Address:** Enter the external IP address or the DNS name of the router or firewall in this field. When contacting other SIP devices, the camera will quote this address as its reply address instead of the camera's own (private) IP address. The router/firewall has to redirect the audio data to the corresponding port of the camera.

### Codec Settings

The camera can use different audio codecs for transferring voice data. After the connection has been established, the SIP devices will use the SIP protocol to agree on a codec to use for encoding and decoding the audio data. If possible, you should use the factory default settings of the MOBOTIX camera.

Codec Settings	
Use PCMA Codec	<input checked="" type="checkbox"/> Activate or deactivate the use of the PCMA codec.
Use GSM Codec	<input type="checkbox"/> Activate or deactivate the use of the GSM codec.
Use PCMU Codec	<input checked="" type="checkbox"/> Activate or deactivate the use of the PCMU codec.

- **Use PCMA Codec (G.711a):** The PCMA audio codec creates uncompressed audio data with 8 kHz and *a-Law encoding*; the audio quality corresponds to that of ISDN. The actual bandwidth required by this codec is 86 kbps (10.4 kB/s).
- **Use GSM Codec:** The GSM audio codec uses a lossy compression to reduce the size of the audio data; the audio quality corresponds to that of GSM mobile phones. The actual bandwidth required by this codec is 35 kbps (4.2 kB/s).
- **Use PCMU Codec (G.711u):** The PCMU audio codec corresponds to the PCMA codec except for encoding, which uses *μ-Law* instead of *a-Law*.

Three codecs:

- PCMA
- GSM
- PCMU

### 9.3 Camera Phone (Listen, Speak and Intercom Modes)

Open the **Admin Menu > Loudspeaker and Microphone** dialog and enter a phone number. As soon as you click one of the buttons (**Listen**, **Speak**, **Intercom**), the camera will call this number. Use this feature for testing the phone connection of the camera or for establishing quick connections to the camera, for example.

**Phone Dial-Out**

Phone Type:  SIP  ISDN  
Selects the phone type to call (ISDN or SIP).

Phone Number or SIP Address:   
Enter the phone number or SIP address the camera will dial.

Listen only:  Use this function if you want to listen by telephone to what the camera's microphone is recording.

Speak only:  The camera calls you, records your voice message over the telephone and plays it back on its internal loudspeaker.

Intercom:  The camera calls you and simulates an intercom over telephone line. To minimize distortions the camera's microphone is muted when you speak.

Hints:

- The browser window may remain empty while the camera makes a call!
- Best audio quality is achieved if the [speaker level](#) does not exceed a value of 3!

If the **SIP** option does not appear in this list, configure **VoIP** in **Admin Menu > VoIP Settings**

#### Using the Camera Phone:

- 1) Select the phone type to call (*SIP* or *ISDN*).
- 2) Enter the phone number or SIP address for the camera to dial.
- 3) Select a function:
  - **Listen:** Click on the **Listen** button to hear the audio data from the MOBOTIX camera when it calls a phone.
  - **Speak:** Click on the **Speak** button to make an announcement from the phone on the speaker of the MOBOTIX camera.
  - **Intercom:** Click on the **Intercom** button to use the camera for two-way communication or as an intercom system.

The camera will call the phone number or SIP address you entered.

Camera Phone using either **SIP** or **ISDN**

#### Note

**By factory default, you can easily establish an ISDN connection to the camera (e.g. for testing purposes) in the Camera Phone dialog. This does not require any further configuration of the camera.**

Make sure that **VoIP** has been set up properly if you would like to use a SIP connection (**Admin Menu > VoIP Settings**)

## 9.4 Phone Profiles: Outbound Phone Calls

The MOBOTIX camera uses the information stored in the profiles of the **Admin Menu > Phone Profiles** dialog to place outbound (voice) phone calls. The phone profiles are used in other dialogs to place automatic phone calls (CL), e.g. as a reaction to the events selected in **Setup Menu > Messaging**, **Setup Menu > Messaging 2** and **Admin Menu > File Server Tests**.

To test a phone profile, select the desired profile in the **Name** list at the top of the page and click on the **Test** button.

Click on the **Add new profile** button at the bottom of the dialog to create an additional profile. In order to delete a profile, activate the **Delete** checkbox and click on the **Set** button, then click on **Close** and store the configuration.

For additional information on this topic, see section 7.8.4, *Phone Profiles*.

The **SIP** connection type only appears in this list, if **VoIP** has been activated in **Admin Menu > VoIP Settings**

**MOBOTIX M10 mxcam Phone Profiles**

**Test Profile**

Name: AlarmCall [dropdown] [Test] Note: Set the changes to a profile *before* you test it.

**Profile Configuration**

Profile	Phone Number or SIP Address	Dial Attempts	Dial Timeout	
<input type="checkbox"/> Delete	00496313033...	1 [dropdown]	20 [dropdown]	[Remove]
	0049177...	1 [dropdown]	20 [dropdown]	[Remove]
				[Add]

Connection type:  SIP  ISDN [dropdown]

Message name: [dropdown]

Confirm call with PIN code: 1357

After the message has been sent: Intercom [dropdown]

Camera Remote Control: On [dropdown]

Hangup after: 1 minute [dropdown]

If you intend to use all audio modes (*Speak, Listen, Intercom*) make sure you have activated all options in the [Loudspeaker and Microphone](#) dialog.

**Note:** configure the remote control parameters (e.g. the dial-out profile) in the [Phone Call-In](#) dialog.

[Add new profile]

**Explanation:** Every profile can store several phone numbers or SIP addresses which will be tried in turns until the call is answered. **Dial Timeout** controls the timeout for each call and **Dial Attempts** limits the number of calls for each phone number or SIP address.

[Set] [Factory] [Restore] [Close]

## Configuration

- **Profile:** The **Profile** field contains the name of the profile. This name is used in other dialogs to select the proper phone profile when configuring a Phone Call-Out action (CL).
- **Phone Number or SIP Address:** Enter the phone number or SIP address, which the camera should call in case of an alarm. Set the remaining parameters as required (**Dial Attempts** and **Dial Timeout**). Click on the **Add** button to add phone numbers or SIP addresses to this profile.

When executing a phone profile, the camera will call the first number or SIP address at the top of the list. If the recipient of the call cannot be reached using the specified number of dial attempts (or if the proper PIN has not been entered), the camera will try calling the second number or SIP address of this profile, then the third number, etc.

- **Connection type:** This parameter sets the connection type of the phone profile (*SIP* or *ISDN*).
- **Message name:** The camera will play back this prerecorded voice message when the recipient accepts the call. The voice message provides an ideal means for identifying the calling camera (e.g. *"MOBOTIX camera, gate 5; gate has been opened"*).
- **Confirm call with PIN code:** Enter a **PIN** code (**P**ersonal **I**dentification **N**umber), if you would like to prevent unauthorized access to the camera. Upon accepting the call, the MOBOTIX camera will prompt the recipient to enter the PIN code on the phone keys. This will only work if the phone supports touchtones (DTMF tone dialing).

Please note: When using SIP connections, the called phone and the SIP provider will have to support touchtones, as it is otherwise impossible to enter the PIN number of the calling MOBOTIX camera. Make sure that the SIP provider also supports DTMF tone dialing.

- **After the message has been sent:** Select the audio mode of the camera after it has established the connection and played back the selected voice message:
- **Hangup after:** The camera will drop the connection after it has played back the voice message. Note that using this option will prevent remote-controlling the camera. For additional information on this topic, see section 9.6, *Remotely Controlling the Camera Using a Phone*.
- **Listen:** This option will transmit the sound from the camera microphone to the called phone. The transmission of audio data from the phone to the camera is disabled when using this setting.
- **Speak:** This option allows making an announcement from the phone via the camera's built-in speaker. The camera will not transmit the sound of the camera microphone when using this option.

A PIN may only consist of six digits (0 ... 9).

Make sure that your SIP provider also supports DTMF tone dialing when activating the PIN as you will not be able to enter the PIN otherwise!



The **Camera Remote Control** and **Hangup after** parameters are only available if **After the message has been sent** has been set to either *Speak*, *Listen* or *Intercom*

- **Intercom:** This option allows communicating with a person by using the camera microphone and speaker, thus simulating an intercom system.
- **Camera Remote Control:** Set this option to *On* if you would like to allow remote-controlling the camera using touchtone phone keys. For additional information on this topic, see section 9.6, *Remotely Controlling the Camera Using a Phone*.
- **Hangup after:** This option sets the maximum duration of the connection. After this time has passed, the camera will automatically drop the connection.

## 9.5 Phone Call-In: Inbound Phone Calls

Open **Admin Menu > Phone Call-In** to configure the MOBOTIX camera for accepting inbound (voice) phone calls.

The screenshot shows the 'Phone Call-In Settings' page in the MOBOTIX Admin Menu. A dropdown menu is open over the 'Phone Call-In' field, showing the following options: 'Disabled', 'ISDN only', 'VoIP only', and 'ISDN and VoIP' (which is selected). The page contains the following configuration fields:

- Phone Call-In:** A dropdown menu with the selected option 'ISDN and VoIP'. Description: 'Activate or deactivate ISDN and VoIP phone calls into the camera.'
- Camera MSN:** A text input field containing '3033130'. Description: 'The MSN is one of several phone numbers that may be assigned to your camera when using ISDN. This means you can operate e.g. a phone, a PC and the camera on the same ISDN bus, provided that the devices have different MSNs. Depending on the country and the telephone system, it may be difficult to determine the correct MSN. To help you find a valid MSN for your camera, the last called MSN detected on the ISDN bus is shown here: **Unknown**. Simply call the camera from a phone, then close and reopen this page to see the MSN. Enter this MSN.'
- Accepted Phone Numbers or SIP Addresses:** A text area containing '00496313033...', '0049177...', 'mxcam@192.168.0', and '.12'. Description: 'You can enter several phone numbers or SIP addresses, one per line. Only calls *originating from* these numbers or SIP addresses will be answered by the camera. To help you identify the caller, the *last caller's number* is shown here: **Unknown**; the *last calling SIP address* is shown here: **Unknown**. Simply call the camera from a device that you want to be able to access your camera, close and reopen this page and add the phone number or SIP address to the list. If you do not enter anything, all calls will be answered. For security reasons this is not recommended!'
- Welcome Message:** A dropdown menu set to 'Standard'. Description: 'Select the voice message that callers will hear, e.g. to greet them or to identify the camera.'
- PIN Code:** A text input field containing '1357'. Description: 'You can enter a **Personal Identification Number** to restrict access to the camera. If a PIN code is set, the caller has to enter this code using the telephone's keypad.'
- Audio Mode:** A dropdown menu set to 'Intercom'. Description: 'Select the audio mode. The available audio modes depend on your [audio](#) settings and the model of the camera.'
- Intercom Settings:** Two dropdown menus for 'Threshold' and 'Duration', both set to 'Medium'. Description: 'The **Intercom** audio mode simulates an intercom between the camera and a telephone. To minimize distortions, the camera's microphone is muted when you speak into the telephone. For muting to work properly, you can configure the following two parameters: **Threshold** specifies the level when the camera's microphone is muted and the **Duration** is the minimum time during which the microphone is muted.'
- Hangup call after:** A dropdown menu set to '5 minutes'. Description: 'Enter a limit for the maximum duration of a call.'
- E-Mail Profile:** A dropdown menu set to 'MailSystemStatus24'. Description: 'After connecting to the camera successfully, you can send the last event image by pressing 5 on your telephone's keypad. Select the [e-mail profile](#) you would like to use for sending.'
- Dial-out Profile:** A dropdown menu set to 'AWV\_ISDN\_Arcor'. Description: 'Using phone call-in, you can manually initiate an ISDN dial-out connection (e.g. to the Internet). Configure at least one [dial-out profile](#) and select the dial-out profile you would like to use. Start the connection by pressing '2' on your telephone's keypad. It is recommended to close the connection manually by either pressing '2' again on the phone or by using a softbutton.'
- Dial-out Idle Time:** A dropdown menu set to '60 seconds'. Description: 'The camera will close the ISDN dial-out connection after it has been idle for the selected duration. Note: This setting overrides the timeout value configured in [ISDN Dial-Out Connections](#) dialog.'

At the bottom of the page, there are four buttons: 'Set', 'Factory', 'Restore', and 'Close'.

By factory default, MOBOTIX cameras do not accept inbound phone calls

The **VoIP** option only appears in this list, if **VoIP** has been activated in **Admin Menu > VoIP Settings**

### Configuration

- **Phone Call-In:** This parameter serves as a main switch and instructs the MOBOTIX camera how to handle inbound phone calls (*Disable, ISDN only, VoIP only, ISDN and VoIP*).
- **Camera MSN:** The Camera MSN (Multiple Subscriber Number) allows identifying the caller when calling via an ISDN connection. The MSN entered in this field will be shown on the display of the called phone (if this phone supports this feature). Enter the MSN without any prefixes or extra characters (your phone provider should have given you this information).

If the camera is connected directly to an **ISDN NT**, enter one of the MSNs of this phone line. Make sure that this MSN has not yet been assigned to another device within your ISDN network. Otherwise, calls will be accepted by both devices (they will both "ring").

If the camera is connected to an **ISDN phone system**, the MSN may be hard to determine. The camera software can assist you in finding and entering the MSN: Call the camera and then refresh the **Phone Call-In** dialog. The camera recognizes and displays the MSN, allowing you to copy the MSN to the corresponding field.

- **Accepted Phone Numbers or SIP Addresses:** The camera can be configured to either react to all incoming calls (factory default) or only to the phone numbers or SIP addresses entered here.

In order to create a list of accepted telephone numbers, enter the phone numbers and SIP addresses in the text box, one per line.

The camera software can assist you in finding and entering the phone numbers and SIP addresses. Open the **Phone Call-In** dialog after calling the camera. The camera recognizes and displays the phone number or SIP address of the last caller (you may have to reload the page to see this), allowing you to copy this information to the corresponding field by clicking this button:

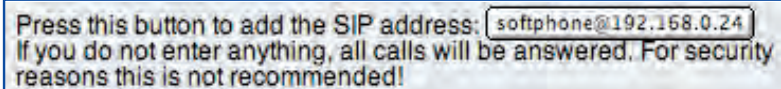

Press this button to add the SIP address:   
If you do not enter anything, all calls will be answered. For security reasons this is not recommended!

**Note:** If this field is empty, the camera will answer every (voice) phone call and may even be remote-controlled, if the settings permit this. For security reasons, entering authorized callers is highly recommended.

- **Welcome Message:** When called, the MOBOTIX camera will play back the selected voice message. You can either use one of the audio files provided in the software or any audio file that you have recorded or uploaded in the **Admin Menu > Manage Voice Messages** dialog.
- **PIN:** Enter a **PIN** code (**P**ersonal **I**dentification **N**umber), if you would like to prevent unauthorized access to the camera. If you have set a PIN, every caller needs to enter this number using the phone keys when prompted ("*Enter PIN*"). This will only work if the phone supports touchtones (**DTMF** tone dialing).

Please note: When using SIP connections, the calling phone and the SIP provider will have to support touchtones (**DTMF**), as it is otherwise impossible to enter the PIN number of the calling MOBOTIX camera. Make sure that the SIP provider also supports DTMF tone dialing.

A PIN may only consist of six digits (0 ... 9).

Make sure that your SIP provider also supports DTMF tone dialing when activating the PIN as you will not be able to enter the PIN otherwise!

- **Audio Mode:** Select the audio mode of the camera after it has established the connection:
  - **No audio:** The audio mode has been disabled. No audio data will be transferred.
  - **Listen only:** This option will transmit the sound from the camera microphone to the phone. The transmission of audio data from the phone to the camera is disabled when using this setting.
  - **Speak only:** This option allows making an announcement from the phone via the camera's built-in speaker. The camera will not transmit the sound of the camera microphone when using this option.
  - **Intercom:** This option allows communicating with a person by using the camera microphone and speaker, thus simulating an intercom system.
    - **Intercom Settings:** To minimize distortions, the camera microphone is muted when you speak on the phone (half duplex). Keep the factory defaults if there is no important reason to change this setting.
      - **Threshold:** The threshold controls the volume of the audio channel from the phone at which the camera microphone is switched off.
      - **Duration:** Sets the minimum duration during which the microphone is switched off.
- **Hangup call after:** This parameter sets a maximum duration for the call, after which the camera will close the connection automatically.
- **E-Mail Profile, Dial-Out Profile, Dial-Out Idle Time:** **The MOBOTIX camera needs these parameters when the camera is remote-controlled using a voice connection. For additional information on this topic, see section 9.6, Remotely Controlling the Camera Using a Phone.**

### Security Recommendations

If you have activated Phone Call-In, you can call the MOBOTIX camera from any phone. To avoid unauthorized access to the camera, it is recommended to restrict the access:

- Enter the phone numbers and SIP addresses, which are allowed to call the camera.
- Set a PIN to be entered over the phone before any caller can remote-control the camera.

Protect the camera from unauthorized access!



## 9.6 Remotely Controlling the Camera Using a Phone

While calling the MOBOTIX camera on the phone, you can execute remote-control functions using the phone's touchtone keys. For example, pressing the corresponding phone key will prompt the camera from any phone to announce certain information, to change its arming status, to trigger an event, to send an e-mail, to change the audio mode or the status of the signal output—regardless of whether you called the camera or the camera called you.

To be able to remote-control the camera, this feature has to be properly configured in the **Admin Menu > Phone Profiles** and **Admin Menu > Phone Call-In** dialogs. By factory default, remote-controlling the camera when using a **phone profile** has been disabled. Set **Camera Remote Control** to *On* to activate the remote-control feature for this profile. By factory default, remote-controlling the camera when using **Phone Call-In** is always enabled, but protected by a PIN.

Camera Remote Control:

Confirm call with PIN code:

Make sure that your SIP provider also supports DTMF tone dialing when activating the PIN as you will not be able to enter the PIN otherwise!

A PIN may only consist of six digits (0 ... 9). For security reasons, you should change the factory default PIN!

Obtain camera information

### Note

In order to use the remote control features of the MOBOTIX camera, the phone has to support touch tones (**DTMF Dial Tone Multi Frequency**). Make sure that the SIP provider also supports DTMF tone dialing.

Once the phone connection has been established successfully, you can execute the camera functions by pressing the appropriate key on the phone. **The MOBOTIX camera will repeat the number you entered and will announce the function. The selected function will only be executed if you press the hash key "#" on the phone after the announcement has finished.** Any command not announced by the camera is either not available or the camera has not recognized it. Note that the camera will not accept any commands while it is still speaking.

- **1 - Announce camera information**

Pressing the "1" key on the phone and confirming with the # key will prompt the camera to announce the time and date of the last event and the status of the Internet connection. Example:

- Announcement of the camera after pressing "1":

*1 ... Camera status*

- Announcement of the camera after pressing "#":

*Last Event: today, 4:56 pm ... Connection status: offline*

- **2 – Control dial-out connection (ISDN)**

Pressing the "2" key on the phone and confirming with the # key will prompt the camera to establish a connection to the Internet using ISDN or to drop an existing ISDN data connection.

If the connection has been established successfully, the MOBOTIX camera announces its IP address. You can then access the camera via Internet by entering this IP address in a browser window. If no data is being transferred, the camera will drop the connection after the duration set for the **Dial-Out Idle Time** parameter. Example:

- Announcement of the camera after pressing "2":  
*2 ... Connect to Internet?*
- Announcement of the camera after pressing "#":  
*Please wait ...* (The camera announces its IP address.)

**Prerequisites for establishing an ISDN dial-out connection:**

- Properly configured Dial-Out Profile (**Admin Menu > ISDN Data Connections > Dial-Out Connections**)
- ISDN connection set as default route (**Admin Menu > Routing**)
- Dial-out profile specified (**Admin Menu > Phone Call-In**)

- **3 - Control camera arming**

Pressing the "3" key on the phone and confirming with the # key will prompt the camera to switch the arming status of the camera (**Setup Menu > General Event Settings**). The camera will announce the arming status that will be valid after pressing the # key. Note that arming can also be controlled by a Time Table profile as this might interfere with this command. Example:

- Announcement of the camera after pressing "3":  
*3 ... Disable arming?*
- Announcement of the camera after pressing "#":  
*OK*

- **4 – Announce the camera's date and time**

Pressing the "4" key on the phone and confirming with the # key will prompt the camera to announce its current date and time. Example:

- Announcement of the camera after pressing "4":  
*4 ... Date and time*
- Announcement of the camera after pressing "#":  
*March 14 ... 9:41 am*

Start the ISDN dial-out connection



Activate/deactivate camera arming

Announce the camera's date and time

Send e-mail with last event image



Trigger **User Click** event

Activate **Listen** audio mode

Activate **Speak** audio mode (announcement using camera speaker)

- **5 - Send an e-mail with the latest event image as attachment**

Pressing the "5" key on the phone and confirming with the # key will prompt the camera to send an e-mail. Note that you have to select an e-mail profile in **Admin Menu > Phone Call-In** before the camera will execute this command.

- Announcement of the camera after pressing "5":  
*5 ... Send e-mail*
- Announcement of the camera after pressing "#":  
*OK*

- **6 - Trigger the User Click (UC) event**

Pressing the "6" key on the phone and confirming with the # key will prompt the camera to trigger the UC (User Click) event.

- Announcement of the camera after pressing "6":  
*6 ... User Click event*
- Announcement of the camera after pressing "#":  
*OK*

- **7 - Switch to Listen audio mode**

Pressing the "7" key on the phone and confirming with the # key will let you hear the sound recorded by the camera microphone. The camera speaker is off to prevent background noise from the phone from being played back on the camera speaker.

- Announcement of the camera after pressing "7":  
*7 ... Listen only*
- Announcement of the camera after pressing "#":  
*OK*

- **8 - Switch to Speak audio mode**

Pressing the "8" key on the phone and confirming with the # key allows making an announcement on the camera speaker. The camera microphone is off to prevent background noise from the camera from being transferred to the phone.

- Announcement of the camera after pressing "8":  
*8 ... Speak only*
- Announcement of the camera after pressing "#":  
*OK*

- **9 - Switch to Intercom audio mode**

Pressing the "9" key on the phone and confirming with the # key will prompt the camera to activate the Intercom audio mode, allowing you to communicate with the person in front of the camera. While the camera speaker is active, the camera microphone will be switched off (half duplex).

- Announcement of the camera after pressing "9":

*9 ... Intercom*

- Announcement of the camera after pressing "#":

*OK*

- **0 - Switches to the Enhanced Signal Out Options menu**

Pressing the "0" key on the phone and confirming with the # key will prompt the camera to switch to the **Signal Output** menu. Pressing the appropriate phone keys will execute the options of the signal output menu.

- Announcement of the camera after pressing "0":

*0 ... Signal out menu*

- Announcement of the camera after pressing "#":

*OK*

For more information on this topic, see the *Signal Output* topic in the camera help and the reference manual.

Activate **Intercom** audio mode

Control the camera's signal output



## 9.7 Sample Configurations for IP Telephony via Internet

### 9.7.1 Overview

Configuring devices for IP telephony (MOBOTIX camera, IP phone, softphone) **means making only a few basic changes** to the devices and in the software (mainly entering network and user settings). Once these parameters have been set, the devices can establish VoIP connections just like regular telephones.

The following examples are based on the assumption that you are running a 192.168.0.x C class network with a 255.255.255.0 network mask, that the gateway is 192.168.0.254, the DNS server is 192.168.0.254 and that you are not using a proxy server. Replace these network addresses with the addresses that are valid on your network.

#### Note

The configuration used to demonstrate IP telephony via Internet in this example requires direct and permanent Internet access, e.g. by using a gateway or a DSL router. On the other hand, the devices can be connected to a LAN or router using WiFi/WLAN.

Direct SIP telephony using static IP addresses

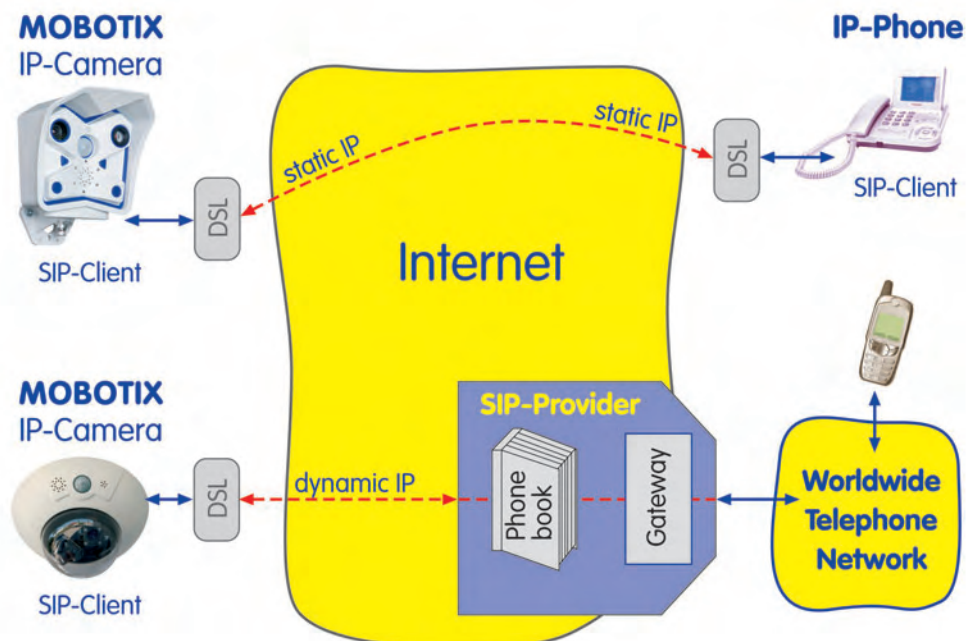

SIP telephony using SIP provider



### Configuring the VoIP Settings

Set the VoIP parameters (**Admin Menu > VoIP Settings**).

- VoIP: *Activated*
- User Name: SIP user name registered with the SIP provider
- SIP Domain: **sipgate.com**, depends on the provider
- Registration Server: e.g. **sip:sipgate.com**, ...
- Registration User Name: (Login name registered with the SIP provider)
- Registration Password: (Login password registered with the SIP provider)

Configure the SIP client of the MOBOTIX camera

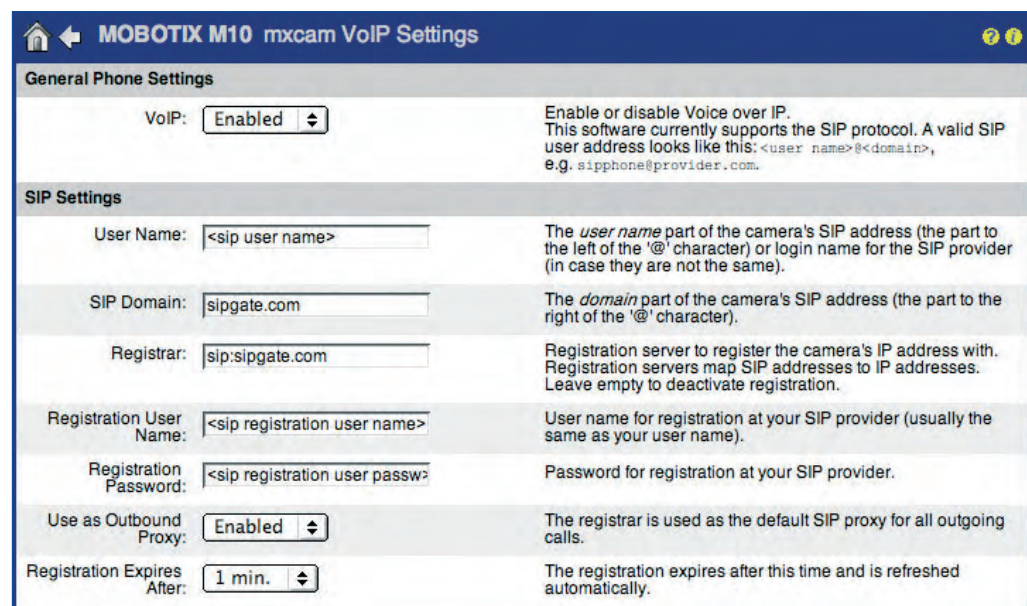

General Phone Settings	
VoIP:	Enabled
Enable or disable Voice over IP. This software currently supports the SIP protocol. A valid SIP user address looks like this: <user name>@<domain>, e.g. sipphone@provider.com.	
SIP Settings	
User Name:	<sip user name>
The <i>user name</i> part of the camera's SIP address (the part to the left of the '@' character) or login name for the SIP provider (in case they are not the same).	
SIP Domain:	sipgate.com
The <i>domain</i> part of the camera's SIP address (the part to the right of the '@' character).	
Registrar:	sip:sipgate.com
Registration server to register the camera's IP address with. Registration servers map SIP addresses to IP addresses. Leave empty to deactivate registration.	
Registration User Name:	<sip registration user name>
User name for registration at your SIP provider (usually the same as your user name).	
Registration Password:	<sip registration user passw>
Password for registration at your SIP provider.	
Use as Outbound Proxy:	Enabled
The registrar is used as the default SIP proxy for all outgoing calls.	
Registration Expires After:	1 min.
The registration expires after this time and is refreshed automatically.	

The MOBOTIX camera can now be reached using the **phone number** or **SIP address** assigned by your SIP provider.

#### Note

Note that only one SIP device should use one specific SIP account. If you would like to use a MOBOTIX camera, an IP phone and a soft-phone on the same network, you should register three different SIP users, i.e. you should create three different SIP accounts. Some SIP providers actually allow using several devices with the same accounts information in parallel (e.g. Sipgate). However, this is not necessarily so with all providers. Contact your SIP provider, if you need more information on this topic.



## Configuring Phone Call-In

Configure the parameters for inbound voice calls (**Admin Menu > Phone Call-In**).

- Phone Call-In: *VoIP only*
- Welcome Message: *Standard* (or another previously recorded voice message)
- Audio Mode: *Intercom*

**Phone Call-In Settings**

Phone Call-In: **VoIP only** Activate or deactivate ISDN and VoIP phone calls **into** the camera.

Accepted Phone Numbers or SIP Addresses:  You can enter several phone numbers or SIP addresses, one per line. Only calls *originating from* these numbers or SIP addresses will be answered by the camera. To help you identify the caller, the *last caller's number* is shown here: **Unknown**; the *last calling SIP address* is shown here: **Unknown**. Simply call the camera from a device that you want to be able to access your camera, close and reopen this page and add the phone number or SIP address to the list.

If you do not enter anything, all calls will be answered. For security reasons this is not recommended!

Welcome Message: **Standard** Select the voice message that callers will hear, e.g. to greet them or to identify the camera.

PIN Code: **1357** You can enter a **Personal Identification Number** to restrict access to the camera. If a PIN code is set, the caller has to enter this code using the telephone's keypad.

Audio Mode: **Intercom** Select the audio mode. The available audio modes depend on your [audio](#) settings and the model of the camera.

Intercom Settings: Threshold: **Medium** Duration: **Medium** The **Intercom** audio mode simulates an intercom between the camera and a telephone. To minimize distortions, the camera's microphone is muted when you speak into the telephone. For muting to work properly, you can configure the following two parameters: **Threshold** specifies the level when the camera's microphone is muted and the **Duration** is the minimum time during which the microphone is muted.

Hangup call after: **5 minutes** Enter a limit for the maximum duration of a call.

E-Mail Profile: **MailSystemStatus24** After connecting to the camera successfully, you can send the last event image by pressing 5 on your telephone's keypad. Select the [e-mail profile](#) you would like to use for sending.

Dial-out Profile: **AWW\_ISDN\_Arcor** Using phone call-in, you can manually initiate an ISDN dial-out connection (e.g. to the Internet). Configure at least one [dial-out profile](#) and select the dial-out profile you would like to use. Start the connection by pressing '2' on your telephone's keypad. It is recommended to close the connection manually by either pressing '2' again on the phone or by using a softbutton.

Dial-out Idle Time: **60 seconds** The camera will close the ISDN dial-out connection after it has been idle for the selected duration. Note: This setting overrides the timeout value configured in [ISDN Dial-Out Connections](#) dialog.

Buttons: Set, Factory, Restore, Close

Configure Phone Call-In (voice) connections to the camera



### Creating the Phone Profiles (Voice Call-Out)

Configure a phone profile (**Admin Menu > Phone Profiles**).

The SIP addresses of this example are also used in the following sections when configuring an IP phone and a softphone. Once the IP phone and the softphone have been set up properly, you can test the phone profile of the MOBOTIX camera using the **Test** button. Next, you can assign this profile to a certain event (**Setup Menu > Messaging**). In case of an alarm, the configured SIP addresses will be called one after another.

- Profile: **AlarmMessage** (name is freely definable)
- Phone number 1: **06313033...**
- Phone number 2: **0177..., mxcam@sipprovider.com, ...**
- Dial Attempts: **1**
- Idle Time: **5 (seconds)**
- Connection type: **SIP**
- Message name: **Standard**
- After the message has been sent: **Intercom**

Set up phone profiles for voice connections from the camera

**MOBOTIX M10 mxcam Phone Profiles**

**Test Profile**

Name:   Note: Set the changes to a profile *before* you test it.

**Profile Configuration**

Profile	Phone Number or SIP Address	Dial Attempts	Dial Timeout	
<input type="checkbox"/> Delete	<input type="text" value="00496313033..."/>	<input type="text" value="1"/>	<input type="text" value="20"/>	<input type="button" value="Remove"/>
	<input type="text" value="0049177..."/>	<input type="text" value="1"/>	<input type="text" value="20"/>	<input type="button" value="Remove"/>
	<input type="text" value="softphone@192.168.0.24"/>	<input type="text" value="1"/>	<input type="text" value="20"/>	<input type="button" value="Remove"/>
				<input type="button" value="Add"/>

Connection type:

Message name:

Confirm call with PIN code:

After the message has been sent:  If you intend to use all audio modes (*Speak, Listen, Intercom*) make sure you have activated all options in the [Loudspeaker and Microphone](#) dialog.

Camera Remote Control:

Hangup after:

**Explanation:** Every profile can store several phone numbers or SIP addresses which will be tried in turns until the call is answered. **Dial Timeout** controls the timeout for each call and **Dial Attempts** limits the number of calls for each phone number or SIP address.

### 9.7.3 Setting up an IP Phone

This example uses a **Snom IP phone** to demonstrate the configuration of an IP phone. For more information on Snom products, go to [www.snom.com](http://www.snom.com).



We recommend using the web interface when configuring the device. Immediately after connecting the power supply to the Snom IP phone, it will display its IP address on the display.

#### Enhanced Settings:

- DHCP: *Off*
- IP Address: **192.168.0.12** (IP address of the IP phone)
- Net mask: **255.255.255.0** (network mask of your network)
- IP Gateway: **192.168.0.254** (gateway of your network)
- DNS Server 1: **194.25.2.129** (or a different DNS server)

**Advanced Settings**

<b>Operation</b> Home Address Book <b>Setup</b> Preferences Speed Dial Function Keys Line 1 Line 2 Line 3 Line 4 Line 5 Line 6 Line 7 Action URL Settings Advanced Trusted Certificates Software Update <b>Status</b> System Information Log SIP Trace UPnP Trace DNS Cache PCAP Trace Memory Settings <b>Manual</b>	<p><b>Network:</b></p> DHCP: <input checked="" type="radio"/> on <input type="radio"/> off IP address: <input type="text" value="192.168.0.32"/> Netmask: <input type="text" value="255.255.255.0"/> Phone name: <input type="text"/> IP Gateway: <input type="text" value="192.168.0.254"/>  <p><b>DNS:</b></p> Domain: <input type="text"/> DNS Server 1: <input type="text" value="194.25.2.129"/> DNS Server 2: <input type="text"/>  <p><b>Time:</b></p> NTP Time Server: <input type="text"/> Timezone: <input type="text" value="-9 United States - Pacific Time"/>  <p><b>HTTP:</b></p> User: <input type="text"/> Password: <input type="text"/> Authentication Scheme: <input type="radio"/> Digest <input checked="" type="radio"/> Basic HTTP Proxy: <input type="text" value="80"/> HTTP port: <input type="text" value="443"/> HTTPS port: <input type="text"/> Register http contact: <input type="radio"/> on <input checked="" type="radio"/> off Webserver connection type: <input type="text" value="http or https"/>
---	--

Set up Snom IP phone

**Line 1:**

- Account Name: (Your login name registered with the SIP provider)
- Password: (Your login password registered with the SIP provider)
- Registrar: **sipgate.com**
- Outbound Proxy: **sipgate.com**

### Configuration Line 1

<b>Operation</b> Home Address Book <b>Setup</b> Preferences Speed Dial Function Keys Line 1 Line 2 Line 3 Line 4 Line 5 Line 6 Line 7 Action URL Settings Advanced Trusted Certificates Software Update <b>Status</b> System Information Log SIP Trace UPnP Trace DNS Cache PCAP Trace Memory Settings <b>Manual</b>	<b>Login Information:</b> Displayname: <input type="text"/> Account: <input type="text" value="&lt;your SIP registration name&gt;"/> Password: <input type="password" value="....."/> Registrar: <input type="text" value="sipgate.de"/> Status: <input type="text"/> Mailbox: <input type="text"/> Ringtone: <input type="text" value="Ringer 1"/> Custom Melody URL: <input type="text"/> <b>Advanced Line Settings:</b> Outbound Proxy: <input type="text"/> Music on hold server: <input type="text"/> Display text for idle screen (max. 8 chars): <input type="text"/> Alert Info URL: <input type="text"/> User picture URL: <input type="text"/> Music on hold Streaming URL: <input type="text"/> Dial-Plan String: <input type="text"/> Q-Value: <input type="text" value="1.0"/> Proposed Expiry: <input type="text" value="1 hour"/> Transport: <input type="text" value="auto"/> Offer ICE: <input type="radio"/> on <input checked="" type="radio"/> off Codec 1: <input type="text" value="G.711u"/>
---	--

**Entry Page:**

- Outgoing Identity: ...@sipgate.com

### Welcome to Your Phone!

<b>Operation</b> Home Address Book <b>Setup</b> Preferences Speed Dial Function Keys Line 1 Line 2 Line 3 Line 4 Line 5 Line 6 Line 7	<p>This web interface makes it easy for you to set your phone up correctly and to access the advanced features.</p> <p>To dial a number, just enter the number in the field below. You can enter a simple telephone number (e.g. 0114930398330) or URI like info@snom.com.</p> <p><b>Dial a Number:</b> <input type="text"/> <input type="button" value="Dial"/> <input type="button" value="Hangup"/></p> <p><b>Outgoing Identity:</b> <input type="text" value="001..."/> <input type="button" value="Set"/></p> <p><a href="#">Dialed</a>, <a href="#">Missed</a>, <a href="#">Received</a></p>
--	--

The IP phone can now be reached using the **phone number** or **SIP address** assigned by your SIP provider.

### 9.7.4 Setting up a Softphone

In this example, we are using **X-Lite** to demonstrate how to configure an IP phone. X-Lite is a free softphone for Windows, Linux/UNIX and Mac OS X. For more information, the manual and other software, go to [www.counterpath.com](http://www.counterpath.com).



Setting up X-Lite 2.x

#### Preferences > System Settings > SIP Proxy > Default:

- Enabled: Yes
- Display Name: 001(country code)-... (your SIP phone #)
- Username: (your SIP user name)
- Authorizat. User: (your SIP login name)
- Password: (your SIP login password)
- Domain/Realm: sipgate.com
- SIP Proxy: sipgate.com
- Outbound Proxy: sipgate.com

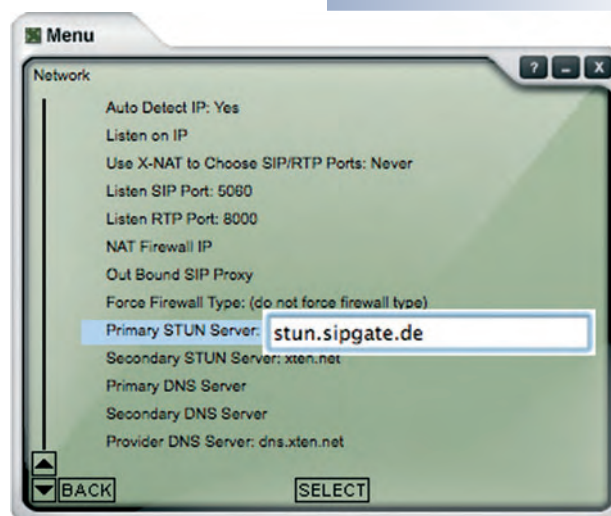
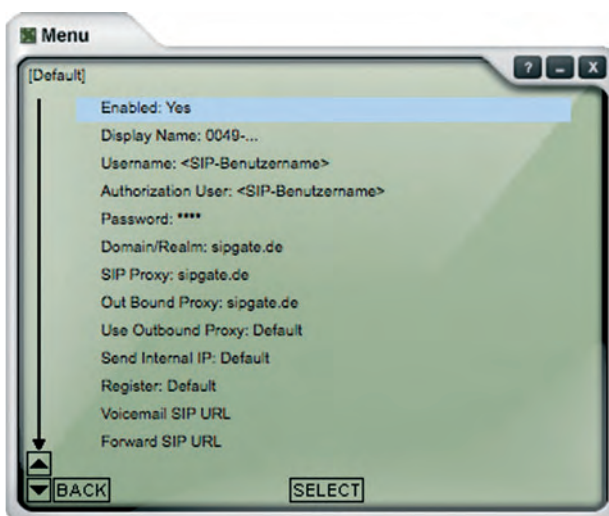

#### Preferences > System Settings > Network:

- Primary STUN Server: e.g. **stun.sipgate.com**

The softphone can now be reached using the **phone number** or **SIP address** assigned by your SIP provider.



## 9.8 Sample Configurations for IP Telephony via LAN

### 9.8.1 Overview

Configuring devices for IP telephony on the LAN (MOBOTIX camera, IP phone, softphone) **means making only a few basic changes** to the devices and in the software (mainly entering network and user settings). Once these parameters have been set, the devices can establish phone connections using their SIP addresses.

The full SIP address of a device could be **sip:username@<IP\_address>** (e.g. **sip:mxcam@10.1.0.99**). This is not a "must", however—VoIP devices are usually smart enough to add the "sip:" prefix if it is missing.

For testing a small IP phone network, for example, all VoIP devices can be connected to one switch. In this case, entering information on the gateway or making DNS entries is not required. This kind of scenario is ideal for getting started with IP telephony and to understand the basic functionality.

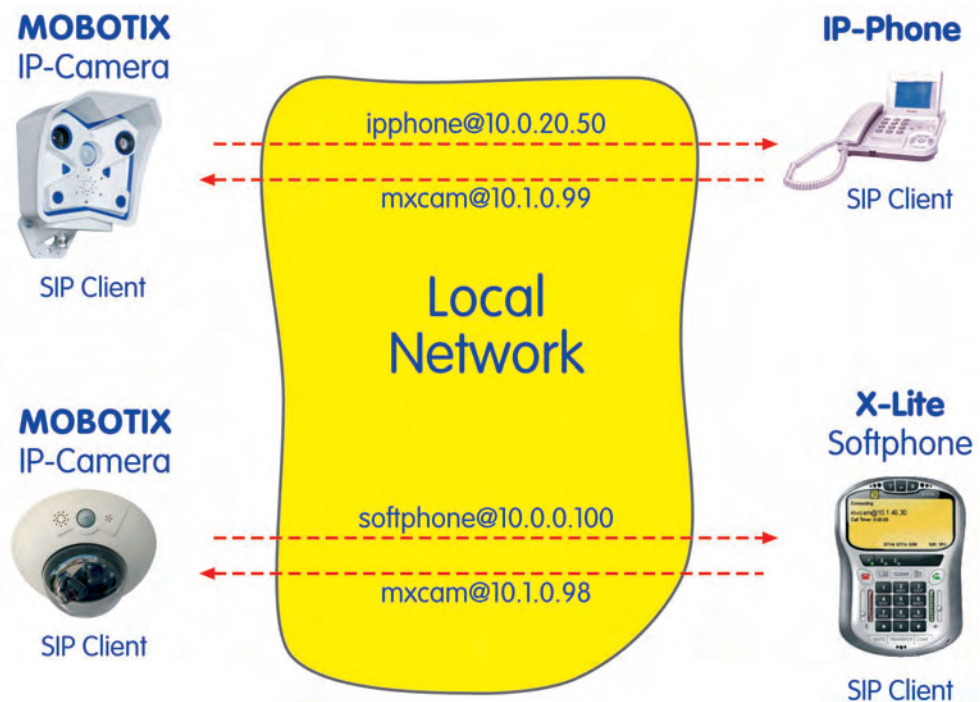

## 9.8.2 Configuring a MOBOTIX Camera

### General Procedure for Setting up the MOBOTIX Camera:

- 1) Configure the **network parameters**.
- 2) Configure the **VoIP settings**.
- 3) Configure the **Phone Call-In parameters**.
- 4) Create the required **Phone Profiles**.
- 5) Link the phone profile to an **event (Messaging)**.

### Configuring the Network Parameters

Set the network parameters (**Admin Menu > Ethernet Interface**).

- Network: *Activated*
- BOOTP/DHCP: *Off*
- Camera Name: **mxcam** (freely definable)
- IP Address: **10.1.0.99** (IP address of your MOBOTIX camera)
- Network Mask: **255.0.0.0**
- Gateway: **10.0.0.1** (optional)

**MOBOTIX M10 mxcam Ethernet Interface**

**General Interface Setup**

Ethernet  Enable/disable the Ethernet interface. Usually, there is no reason to disable the Ethernet interface. If you would like to have a running camera announce its network settings over camera speaker, simply press the **R** button at the front of the camera. This audio feature can be disabled in the [Loudspeaker and Microphone](#) dialog.

Additional IP Address  Configures a second network interface using the factory defaults (IP address: 10.1.9.169, network mask: 255.0.0.0). This allows accessing the camera using two different IP addresses.

BOOTP/DHCP  On. Use BOOTP/DHCP to set network configuration *automatically*. Select **On** to configure the Ethernet interface automatically with values provided by a BOOTP/DHCP server on your local network. Ask your network administrator if BOOTP/DHCP is available! BOOTP/DHCP will be tried first and, if successful, will overwrite previous settings. If it fails, the given or factory default values are used. **Note:** using BOOTP/DHCP, the Default Route always uses the Ethernet interface and the Default Gateway will be set automatically. If ISDN Dial-Out is configured, the camera will dial-out autonomously only with appropriate IP addresses according to the network routes in the [Routing](#) dialog.

Off. Set network configuration *manually*.

Camera Name  Set the computer name of the camera. **Note:** This does not mean that you can address the camera by this name without a DNS/WINS server present. Factory camera name: mx10-1-9-169.

**Ethernet Parameters**

IP Address  Set the address which identifies the camera on the Ethernet. In a non-private (public) network, this address is assigned by the network administrator or the ISP. Factory IP address: 10.1.9.169.

Network Mask  Set the network mask. It specifies the part of the IP address that belongs to the local subnet. Ask your network administrator for the correct network mask. Factory network mask: 255.0.0.0.

**Routing**

Default Route and Gateway IP Address  Default gateway:  Enter the default gateway IP address. Network data packets can use different connections. For a given IP address, network routes define which connection to use. Configure those routes in the [Routing](#) dialog. The **default route** will be used if no other route matches. Currently the default route is set to [this interface](#) using gateway IP address: 10.0.0.1

Delete default route.

### Configuring the VoIP Settings

Set the VoIP parameters (**Admin Menu > VoIP Settings**).

- VoIP: *Activated*
- User Name: **mxcam** (freely definable)
- SIP Domain: **10.1.0.99** (IP address of your MOBOTIX camera)

MOBOTIX M10 mxcam VoIP Settings	
<b>General Phone Settings</b>	
VoIP: <input type="button" value="Enabled"/>	Enable or disable Voice over IP. This software currently supports the SIP protocol. A valid SIP user address looks like this: <user name>@<domain>, e.g. sipphone@provider.com.
<b>SIP Settings</b>	
User Name: <input type="text" value="mxcam"/>	The <i>user name</i> part of the camera's SIP address (the part to the left of the '@' character) or login name for the SIP provider (in case they are not the same).
SIP Domain: <input type="text" value="10.1.0.99"/>	The <i>domain</i> part of the camera's SIP address (the part to the right of the '@' character).
Registrar: <input type="text"/>	Registration server to register the camera's IP address with. Registration servers map SIP addresses to IP addresses. Leave empty to deactivate registration.
Registration User Name: <input type="text"/>	User name for registration at your SIP provider (usually the same as your user name).
Registration Password: <input type="text"/>	Password for registration at your SIP provider.
Use as Outbound Proxy: <input type="button" value="Enabled"/>	The registrar is used as the default SIP proxy for all outgoing calls.
Registration Expires After: <input type="button" value="1 min."/>	The registration expires after this time and is refreshed automatically.
<b>Network Settings</b>	
Use Router Address: <input type="button" value="Disabled"/>	Enable or disable using the IP address of a router with NAT (Network Address Translation) instead of the camera's IP address.
Router Address: <input type="text"/>	The IP address of the router using NAT.
SIP Port: <input type="text" value="5060"/>	Port to use for the SIP protocol.
Audio RTP Port: <input type="text" value="7078"/>	Port to use for the RTP protocol.
<b>Codec Settings</b>	
Use PCMA Codec: <input checked="" type="checkbox"/>	Activate or deactivate the use of the PCMA codec.
Use GSM Codec: <input type="checkbox"/>	Activate or deactivate the use of the GSM codec.
Use PCMU Codec: <input checked="" type="checkbox"/>	Activate or deactivate the use of the PCMU codec.
You can view the current status and detailed messages of the VoIP system in the <a href="#">VoIP Messages and Call Log</a> dialog.	
<input type="button" value="Set"/> <input type="button" value="Factory"/> <input type="button" value="Restore"/> <input type="button" value="Close"/>	

The **MOBOTIX** camera can now be reached using the SIP address **mxcam@10.1.0.99**.



### Configuring Phone Call-In

Configure Phone Call-In so you can call the camera (**Admin Menu > Phone Call-In**).

- Phone Call-In: *VoIP only*
- Welcome Message: *Standard* (or another previously recorded voice message)
- Audio Mode: *Intercom*

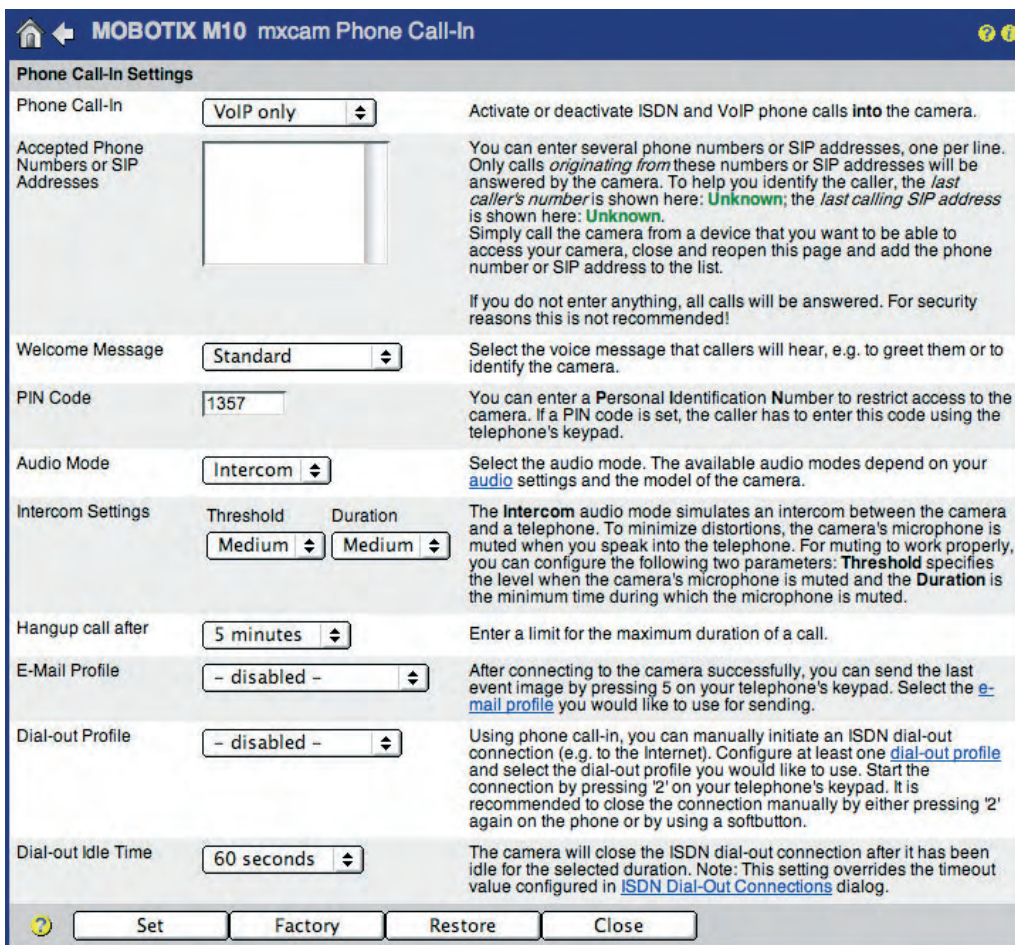



### Creating the Phone Profiles (Voice Call-Out)

Configure a phone profile (**Admin Menu > Phone Profiles**).

The SIP addresses of this example are also used in the following sections when configuring an IP phone and a softphone. Once the IP phone and the softphone have been set up properly, you can test the phone profile of the MOBOTIX camera using the **Test** button. Next, you can assign this profile to a certain event (**Setup Menu > Messaging**). In case of an alarm, the configured SIP addresses will be called one after another.

- Profile: **SIP\_alarm\_ip50\_ip100** (freely definable)
- SIP address 1: **ipphone@10.0.20.50**
- SIP address 2: **softphone@10.0.0.100**
- Dial Attempts: **1**
- Idle Time: **5** (seconds)
- Connection type: **SIP**
- Message name: **Standard**
- After the message has been sent: **Intercom**

**MOBOTIX M10 mxcam Phone Profiles**

**Test Profile**

Name:   Note: Set the changes to a profile *before* you test it.

**Profile Configuration**

Profile	Phone Number or SIP Address	Dial Attempts	Dial Timeout	
<input type="checkbox"/> Delete	<input type="text" value="ipphone@10.0.20.50"/>	<input type="text" value="1"/>	<input type="text" value="5"/>	<input type="button" value="Remove"/>
	<input type="text" value="softphone@10.0.0.100"/>	<input type="text" value="1"/>	<input type="text" value="5"/>	<input type="button" value="Remove"/>
				<input type="button" value="Add"/>

Connection type:

Message name:

Confirm call with PIN code:

After the message has been sent:

Camera Remote Control:

Hangup after:

**Explanation:** Every profile can store several phone numbers or SIP addresses which will be tried in turns until the call is answered. **Dial Timeout** controls the timeout for each call and **Dial Attempts** limits the number of calls for each phone number or SIP address.

### 9.8.3 Setting up an IP Phone

This example uses a **Snom IP phone** to demonstrate the configuration of an IP phone. For more information on Snom products, go to [www.snom.com](http://www.snom.com).



We recommend using the web interface when configuring the device. Immediately after connecting the power supply to the Snom IP phone, it will display its IP address on the display.

#### Enhanced Settings:

- DHCP: *Off*
- IP Address: **10.0.20.50**
- Net mask: **255.0.0.0**
- IP Gateway: **10.0.0.1** (optional)

Not all SIP phones support direct LAN connections!

## Advanced Settings

<p><b>Operation</b></p> <ul style="list-style-type: none"> <li>Home</li> <li>Address Book</li> </ul> <p><b>Setup</b></p> <ul style="list-style-type: none"> <li>Preferences</li> <li>Speed Dial</li> <li>Function Keys</li> <li>Line 1</li> <li>Line 2</li> <li>Line 3</li> <li>Line 4</li> <li>Line 5</li> <li>Line 6</li> <li>Line 7</li> <li>Action URL Settings</li> <li>Advanced</li> <li>Trusted Certificates</li> <li>Software Update</li> </ul> <p><b>Status</b></p> <ul style="list-style-type: none"> <li>System Information</li> <li>Log</li> <li>SIP Trace</li> <li>UPnP Trace</li> <li>DNS Cache</li> <li>PCAP Trace</li> <li>Memory</li> <li>Settings</li> </ul> <p><b>Manual</b></p>	<div style="border: 1px solid #ccc; padding: 10px;"> <p><b>Network:</b></p> <p>DHCP: <input type="radio"/> on <input checked="" type="radio"/> off</p> <p>IP address: <input type="text" value="10.0.20.50"/></p> <p>Netmask: <input type="text" value="255.0.0.0"/></p> <p>Phone name: <input type="text"/></p> <p>IP Gateway: <input type="text" value="10.0.0.1"/></p> <p><b>DNS:</b></p> <p>Domain: <input type="text"/></p> <p>DNS Server 1: <input type="text"/></p> <p>DNS Server 2: <input type="text"/></p> <p><b>Time:</b></p> <p>NTP Time Server: <input type="text"/></p> <p>Timezone: <input type="text" value="-9 United States - Pacific Time"/></p> <p><b>HTTP:</b></p> <p>User: <input type="text"/></p> <p>Password: <input type="text"/></p> <p>Authentication Scheme: <input type="radio"/> Digest <input checked="" type="radio"/> Basic</p> <p>HTTP Proxy: <input type="text"/></p> <p>HTTP port: <input type="text" value="80"/></p> <p>HTTPS port: <input type="text" value="443"/></p> <p>Register http contact <input type="radio"/> on <input checked="" type="radio"/> off</p> <p>Webserver connection type: <input type="text" value="http or https"/></p> </div>
---	--

**Line 1:**

- Account Name: **iphone**
- Registrar: **10.0.20.50**

### Configuration Line 1

<b>Operation</b> Home Address Book <b>Setup</b> Preferences Speed Dial Function Keys Line 1 Line 2 Line 3 Line 4 Line 5 Line 6 Line 7 Action URL Settings Advanced Trusted Certificates Software Update <b>Status</b> System Information Log SIP Trace UPnP Trace DNS Cache PCAP Trace Memory Settings <b>Manual</b>	<b>Login Information:</b> Displayname: <input type="text"/> Account: <input type="text" value="iphone"/> Password: <input type="password"/> Registrar: <input type="text" value="10.0.20.50"/> Status: <input type="text"/> Mailbox: <input type="text"/> Ringtone: <input type="text" value="Ringer 1"/> <input type="button" value="v"/> Custom Melody URL: <input type="text"/> <b>Advanced Line Settings:</b> Outbound Proxy: <input type="text"/> Music on hold server: <input type="text"/> Display text for idle screen (max. 8 chars): <input type="text"/> Alert Info URL: <input type="text"/> User picture URL: <input type="text"/> Music on hold Streaming URL: <input type="text"/> Dial-Plan String: <input type="text"/> Q-Value: <input type="text" value="1.0"/> <input type="button" value="v"/> Proposed Expiry: <input type="text" value="1 hour"/> <input type="button" value="v"/> Transport: <input type="text" value="auto"/> <input type="button" value="v"/> Offer ICE: <input type="radio"/> on <input checked="" type="radio"/> off Codec 1: <input type="text" value="G.711u"/> <input type="button" value="v"/>
---	---

**Entry Page:**

- Outgoing Identity: **iphone@10.0.20.50**

### Welcome to Your Phone!

<b>Operation</b> Home Address Book <b>Setup</b> Preferences Speed Dial Function Keys Line 1 Line 2 Line 3 Line 4 Line 5 Line 6 Line 7	<p>This web interface makes it easy for you to set your phone up correctly and to access the advanced features.</p> <p>To dial a number, just enter the number in the field below. You can enter a simple telephone number (e.g. 0114930398330) or URI like info@snom.com.</p> <div style="border: 1px solid #ccc; padding: 5px;"> <p><b>Dial a Number:</b> <input type="text"/> <input type="button" value="Dial"/> <input type="button" value="Hangup"/></p> <p><b>Outgoing Identity:</b> <input type="text" value="001..."/> <input type="button" value="Set"/></p> </div> <p><a href="#">Dialed</a>, <a href="#">Missed</a>, <a href="#">Received</a></p>
--	---

The IP phone can now be reached on the LAN using the SIP address **iphone@10.0.20.50**.

### 9.8.4 Setting up a Softphone

In this example, we are using **X-Lite** to demonstrate how to configure an IP phone. X-Lite is a free softphone for Windows, Linux/UNIX and Mac OS X.

For more information, the manual and other software, go to [www.counterpath.com](http://www.counterpath.com).



#### Preferences > System Settings > SIP Proxy > Default:

- Enabled: Yes
- Display Name: **softphone@10.0.0.100**
- Username: **softphone**
- Domain/Realm **10.0.0.100**

The IP address and network mask **have to match the settings on your PC**. If you are specifying a gateway and a DNS server, these addresses **should also match the settings on your PC**.

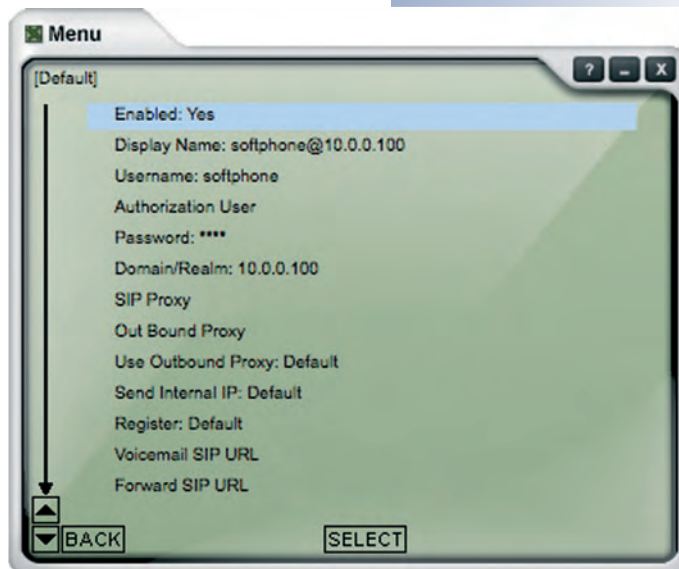

The softphone can now be reached using the SIP address **softphone@10.0.0.100**.



## 9.9 Video Telephony

### 9.9.1 Overview

IP telephony using the SIP protocol can do more than "just" transmit the data for voice connections, it can also transmit video data using a local network or the Internet. Several softphones currently use the SIP protocol for voice and video phone connections. To be able to do this, the voice and video data needs to be compressed so that the application can display smooth live video even when the bandwidth is low (e.g. 126 kbps upstream).

With the current production software, the MOBOTIX M22, M12 and D12 cameras (IT and Secure models) support video telephony. Older cameras of these models will support video telephony when loading the free software update. The video telephony feature expands the range of application scenarios for MOBOTIX cameras:

- **Video telephony via Internet**
- **Video telephony on the LAN**
- **Access control and intercom systems (door communication)**

**eyebeam** softphone with video SIP connection, camera image and displayed legend

The camera is remote-controlled using the softphone keys



The requirements and the configuration for SIP video telephony are mostly identical to those of SIP voice telephony (see section 9.2, *VoIP Settings for IP Telephony*). The only difference is the **Video** parameter in **Admin Menu > VoIP Settings**, which has to be set to *Enabled*.









Besides the MOBOTIX camera, a video-capable softphone is essential to use the video telephony features (e.g. Counterpath **eyebeam**). Softphones are available for a number of operating systems, such as Windows, Macintosh, Linux/UNIX and an array of PDAs and mobile (cell) phones.

### 9.9.2 Remotely Controlling the Camera Using a Softphone

**In addition to the regular telephony features, you can use the softphone keys for remote-controlling the MOBOTIX camera.** If you click on any key of the softphone, the camera automatically displays a legend in the live image, which illustrates the camera commands that are currently available (see below).

For example, you can zoom into the camera image, move the zoomed image area or display the camera's event list. You could also use one (or two) of the camera's signal output lines to switch external appliances (e.g. open doors, switch on lights; this feature is model-dependent).

**The legend shows the commands and the corresponding keys:**

-  Hide legend (#)
-  Activate 2x zoom of the camera (1)
-  Deactivate the zoom (7)
-  Center image area (5)
-  Move zoomed image area in the corresponding direction (2, 4, 6, 7)
-  Show event list (\*)
-  Switch signal output e.g. door opener (0)
-  Switch signal output 2 on (3), e.g. to switch on the lights
-  Switch signal output 2 off (9), e.g. to switch off the lights



**In order to use the Signal Output 2, a MOBOTIX M22 or M12 (IT or Secure model) is required**

Displayed legend for remote-controlling the camera using the softphone keys

Cost-efficient: Intercom system using Video SIP

### 9.9.3 Video Telephony Example: Intercom System

The video telephony features allow using the MOBOTIX cameras as reasonably priced video intercom systems, for example.

- When pressing the door bell, which is connected to the camera's **signal input**, the MOBOTIX camera will trigger an event.
- Upon this event, the MOBOTIX camera will establish a **video intercom connection** (using a phone profile) via network or Internet to a softphone that runs on a computer, PDA or mobile (cell) phone.
- After the recipient of the videophone call has identified the person, he/she can use the softphone keys to activate the door opener, which is connected to the **signal output** of the camera.

#### Advantages of Using MOBOTIX Cameras as Intercom System

- Very cost-efficient.
- Low installation requirements.
- Low maintenance cost.
- Ethernet/CAT5 cables can be used (existing two-wire systems require converters).
- Open standard (Ethernet protocol).
- Easy to set up.
- Flexible: The call can be sent simultaneously to several recipients or by automatically forwarding the call if no one answers: 1) computer at the receptionist's desk, 2) mobile phone of the receptionist, 3) PDA of the security staff ...
- Independent of the location: Using the Internet, the connection can be established to a softphone anywhere in the world.

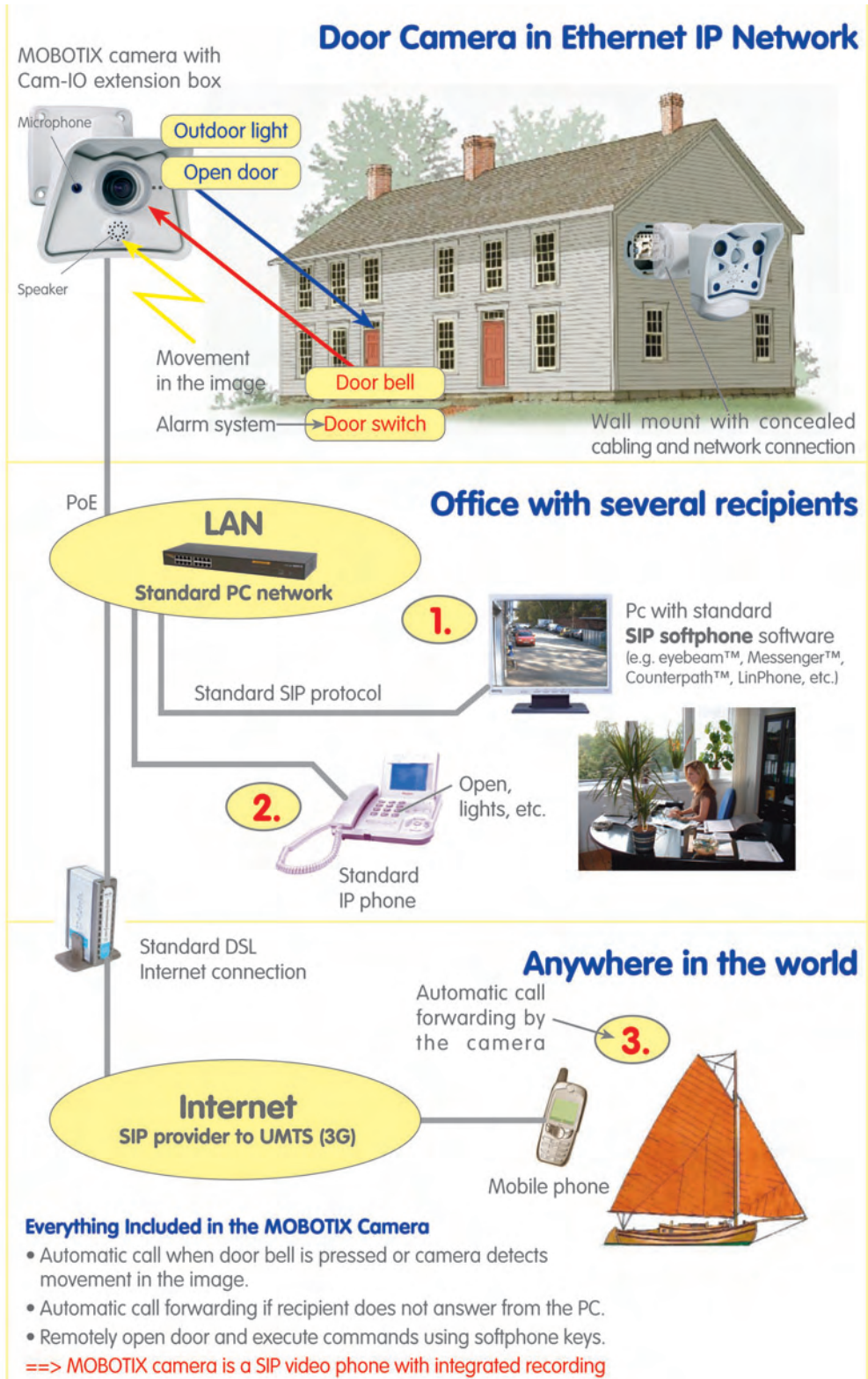



### 9.9.4 Configuring a MOBOTIX Camera for SIP Video Telephony

In addition to the settings for SIP (voice) telephony, (see sections 9.7.2 and 9.8.2), you only need to set a few extra parameters before you can use SIP video.

- **Video Settings:** Make sure that the transmission of video signals has been activated (**Admin Menu > VoIP Settings**).

Video Settings	
Video:	Enabled <input type="button" value="v"/> Enable or disable H.263 video.
Video Size:	QCIF <input type="button" value="v"/> The video resolution.
Video Quality:	50% <input type="button" value="v"/> Sets the quality of the video image. The lower the quality, the lower the required bit rate.

- Deactivate the PIN in **Admin Menu > Phone Call-In**, if the MOBOTIX camera should automatically accept the inbound call from the softphone. The camera will thus start sending the video stream to the softphone once the connection has been established.

Welcome Message	<input type="button" value="none -"/> <input type="button" value="v"/>	Select the voice message that callers will hear, e.g. to greet them or to identify the camera.
PIN Code	<input type="text"/>	You can enter a Personal Identification Number to restrict access to the camera. If a PIN code is set, the caller has to enter this code using the telephone's keypad.
Audio Mode	Intercom <input type="button" value="v"/>	Select the audio mode. The available audio modes depend on your <a href="#">audio</a> settings and the model of the camera.
Intercom Settings	Threshold: <input type="button" value="Medium"/> <input type="button" value="v"/> Duration: <input type="button" value="Medium"/> <input type="button" value="v"/>	The <b>Intercom</b> audio mode simulates an intercom between the camera and a telephone. To minimize distortions, the camera's microphone is muted when you speak into the telephone. For muting to work properly, you can configure the following two parameters: <b>Threshold</b> specifies the level when the camera's microphone is muted and the <b>Duration</b> is the minimum time during which the microphone is muted.
Hangup call after	Never <input type="button" value="v"/>	Enter a limit for the maximum duration of a call.

In addition, you can disable the **Welcome Message** (set to *- none -*) and you could also prevent the camera from hanging up automatically by setting **Hangup call after** to *Never*. Making these settings allows keeping a permanent connection between the softphone and the MOBOTIX camera.

### 9.9.5 Configuring a Softphone for SIP Video Telephone

The softphone applications **eyebeam** and **x-lite 3.x for Windows** support SIP video telephony in connection with MOBOTIX cameras. When a phone connection has been established from or to the MOBOTIX camera, the softphone can automatically display the live video stream of the camera in its upper video window. The live image of a web cam (if attached to the computer) will be displayed in the softphone's lower video window.

You should not have to make additional settings in the softphone options if the SIP audio settings have already been set (see sections 9.7.4 and 9.8.4). You should, however, verify that the following (default) settings of the softphone have been set:

- **Audio Codecs:** Make sure that the audio codecs supported by the MOBOTIX camera have been enabled: **G711 aLaw**, **G711 uLaw** and **GSM**.

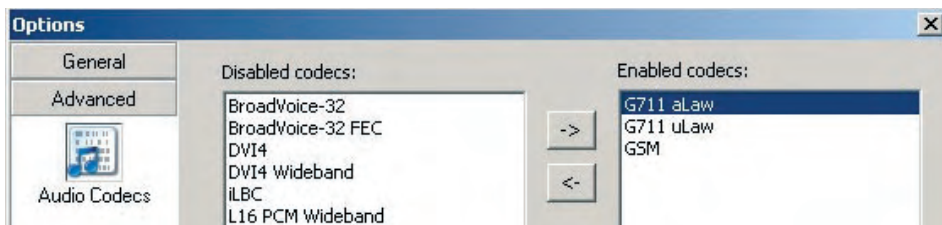

- **Video Codecs:** Make sure that the video codec supported by the MOBOTIX camera has been enabled: **H.263**.

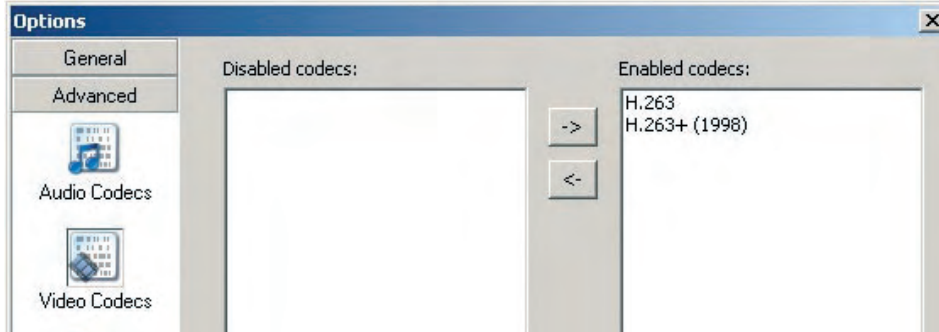

- **Register with domain and receive incoming calls (SIP Account Settings > Properties > Account):** Make sure that this option has been activated in the account properties. If this is not the case, the softphone will not accept incoming phone calls.

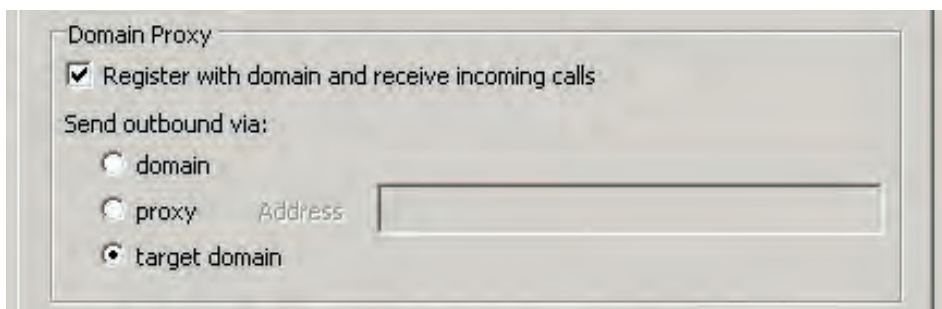

## INDEX

<b>A</b>		Audio and MxPEG, JPEG	26
Accessing		Audio in the browser	27
administration menu	8	Audio on, softbutton	17
cameras	8	Automatic	
PDA screen	42	day/night switching	131
Action		exposure	122, 125
symbols	16	exposure settings	124
Action softbuttons	18	Automatically finding cameras	
Actions		in MxViewer	12
actions, messaging, profiles	169	in the browser	38
display in live image	144	<b>B</b>	
file transfer (FT) action	173	Background information	
general procedure	143	Audio and MxPEG	28
overview, conceptional	140	JPEG	28
overview, functional	142	Motion JPEG	28
signal out (SO) action	172	MPEG	28
visual alarm (VA) action	174	MxPEG	28
Actions, Messaging, Profiles		Backlight correction	123
overview	169	Backlight, Quick Control	23
Activating		Basic Models	7
Supervisor mode	82	Brightness, Quick Control	23
ActiveX plug-in		Browser	
for Internet Explorer	24	ActiveX plug-in	52
installing	25	audio	27
MxPEG	52	cache problems	46
Adding		camera screens	10
cameras in MxViewer	12	frame rate, dropdown	21
cameras in the browser	38	frame rate, setting	22
user groups	82	getting the first image	8
users	82	operating mode	24
Admin Menu	61	PDA screen	10
Admin Menu, softbutton	16	popup blocker problems	46
Administration menu, accessing	8	problems	46
Alerting	19	proxy server problems	46
Archiving		Quick Controls	21
Event Download, softbutton	36	setting the operating mode	24
Archiving events	36	settings for fast video streaming	52
Arm & Record, softbutton	17	softbuttons	8, 16
Arming		Browser, Quick Control	23
by manual control	146	Buttons	
by master camera	147	colored	47
by signal input	147	<b>C</b>	
by time table	146	Calling	
using custom signals	148	camera	245
using slave mode	148	Camera	
Audio and MxPEG		configuration file	133
background information	28	configuration overview	60
		configuring	60

configuring for IP telephony via Internet	253, 261	Compression format and image quality	112
configuring for SIP video telephony	272	Concept	
factory IP address	8	recording	204
help	9	Configuration files	
inbound phone calls	245	copying to other cameras	135
managing camera settings	133	loading	135
phone modes (Listen, Speak, Intercom)	241	overview	133
remote-controlling using a phone	248	Configuring	
status	9	camera	60
Camera buttons (BT) event		camera for IP telephony via Internet	253
explained	152	camera for IP telephony via LAN	261
user events	152	camera for SIP video telephony	272
Camera Help, icon	9	camera, using Quick Installation	64
Camera images		configuration file	133
logos	22	date and time of the camera	92
Camera Information, PDA screen	43	day/night switching	132
Camera Manual Part 1	6	image areas	39
Camera screens		IP phone: Internet	257
Guest	44	IP phone: LAN	265
in the browser	10	LEDs	96
Live	15	sample configuration: IP telephony	
MultiView	37	via Internet	252
PDA	42	sample configuration: IP telephony	
Camera selection	22	via LAN	260
Camera settings		softbuttons	48
for fast video streaming	51	softphone for SIP video telephone	273
Camera settings for high image rates	58	softphone: Internet	259
Camera software		softphone: LAN	267
updating	137	time server of the camera	92
Camera Status, icon	9	time zones	92
Camera user interface	8	Connections	
Cameras		testing	80
accessing	8	Continuous recording	
adding in MxViewer	12	camera settings	214
adding in the browser	38	recording modes	205
day/night cameras	131	Continuous recording	36
defining (browser)	38	Controls	
defining in MxViewer	12	image settings	104
manually defining (MxViewer)	14	Live screen	15
operating multiple	56	MultiView screen	37
Center Pan, softbutton	20	PDA Event List	42
CIF resolution	27	PDA screen	42
Color Saturation, Quick Control	23	Playback screen	30
Color settings	114	Copying	
Colored softbuttons	47	configuration files to other cameras	135
COM In / RS232 (CI) event		Creating	
explained	157	customized screens	41
signal and exposure events	157	passwords	82
		user groups	82
		users	82



Custom signals		Entry page	
arming using custom signals	148	configuring	100
example: with master/slave arming	148	Event	
example: with one key switch	149	recording	35
Customized screens, creating	41	softbuttons	18
Customizing		symbols	16
exposure windows	128	Event Download, softbutton	19
<b>D</b>		Event filter (EC) event	
Date and time	92	explained	166
Day/night		Event list	
cameras	131	button on the PDA screen	43
configuration hints	132	PDA	10
Deactivating		softbutton	19
Quick Controls	21	Event logic (EL) event	
Defining		explained	167
cameras in the browser	38	Event recording	
video sources in MxViewer	12	camera settings	212
Detecting movements	22	Event Watcher	19
Dialogs		Event-controlled	
Exposure Settings	122	e-mail, FTP, storage	32
General Image Settings	104	recording modes	205
Language and Entry Page	100	Events	
Phone Call-In	245	and storage options	32
Phone Profiles	242	archiving	36
Quick Installation	64	camera button (BT) event	152
Text & Display Settings, dialog	108	COM in / RS232 (CI) event	157
VoIP Settings	238	display in live image	144
Display Mode		event filter (EC) event	166
Quick Control	23	event logic (EL) event	167
Displaying		event selection	151
dynamic texts	110	general procedure	143
logos	116	hardware sensor events	154
text in the camera images	108	history recording (RH) event	158
text in the image	15	illumination (IL) event	154
Displaying several cameras		IP receive (RC) event	156
simultaneously	57	IR remote control (IR) event	152
Download Images, link	36	microphone (MI) event	154
Download: Services > Manuals	6	Multiview screen	37
Dropdown		overview, conceptual	140
Browser frame rate	21	overview, functional	142
<b>E</b>		passive infrared sensor (PI) event	154
E-mail		PDA event list	10
event-controlled	32	periodic (PE) event	157
time-controlled	32	random (RD) event	158
E-mail (EM) message		recording begin (RB) event	158
explained	175	recording end (RE) event	158
E-mail (EM) profiles		recording events	158
explained	180	recording terminate (RT) event	158
Elements displayed in the Live image	22	RS232 / COM in (CI) event	157
Enhanced events		searching	36
EC, event filter, event counter	166	signal and exposure events	156
EL, event logic	167	signal input (SI) event	156
		temperature (TP) event	155
		time task (TT) event	157
		time tasks in detail	198

time-related events	157	Focus, MultiView screen	37
user click (UC) event	152	FTP	
user events	152	event-controlled	32
video motion (VM) event	153	time-controlled	32
video motion (VM2) event, second set	165	FTP Profiles	
video motion event, creating		explained	177
windows with the mouse	160	<b>G</b>	
video motion event, in detail	159	General Image Settings, dialog	104
Examples		Guest screen	10, 44
arming with master/slave	148	<b>H</b>	
arming with one key switch	149	Hardware requirements for high image rates	57
configurations for IP telephony:		Hardware sensor events	
Internet	252	IL, illumination	154
configurations for IP telephony: LAN	260	MI, microphone	154
placeholders and variables	111	overview	154
setting up a softphone: Internet	259	PI, passive infrared	154
setting up a softphone: LAN	267	TP, temperature	155
setting up an IP phone: Internet	257	Help	
setting up an IP phone: LAN	265	camera help	9
video intercom system	270	High image rates	
Exclusion windows	129	camera settings	58
Expanded Softbuttons	17	hardware requirements	57
Exposure		multiple cameras	57
automatic	122	History Recording	34
customizing exposure windows	128	History recording	
exclusion windows	129	camera settings	216
exposure windows	125	History recording (RH) event	
options	124	explained	158
Exposure settings	122	recording events	158
Exposure Settings, dialog	122	<b>I</b>	
Exposure windows	23	Icons	
Exposure windows setting	126	Camera Help	9
<b>F</b>		Camera Status	9
Factory IP address of the camera	8	Live screen	10, 15
Fast Mode (30 fps), softbutton	17	MultiView screen	10
Fast video streaming		Playback screen	10
browser settings	52	Illumination (IL) event	
camera settings	51	explained	154
overview	51	hardware sensor events	154
using MxViewer	53	Image areas	
Windows processes	55	configuring	39
Features		Image controls	104
telephony	236	Image files	
Features, Model	6	managing	116
Features, Software	7	Image profiles	
File transfer (FT) action		explained	192
explained	173	Image quality and compression format	
First image		112	
in MxViewer	11	Image search	36
in the browser	8	Image size	
		CIF	27

MEGA	27	LED signals	96
PDA	27	LEDs	
VGA	27	configuring	96
Images		LEDs Blink, softbutton	18
backlight correction	123	Lens	
downloading	36	selecting	22
reducing image noise	132	Limitations, Model	7
searching	36	Listen	
Inbound phone calls	245	camera phone mode	241
Installing		Live button, PDA screen	43
ActiveX plug-in	25	Live image	
and starting MxViewer	12	elements displayed	22
Intercom		logos	22
camera phone mode	241	Live screen	
Intercom system		browser frame rate	22
using the camera as	270	controls	15
Internet Explorer, ActiveX plug-in	24, 52	icon	10
Introduction	6	icons	15
IP notify (IP) message		overview	15
explained	175	Load Default View, softbutton	20
IP notify (IP) profiles		Loading	
explained	186	configuration files	135
IP receive (RC) event		Logo profiles	
explained	156	explained	195
signal and exposure events	156	Logos	
IP telephony		displaying	22, 116
inbound phone calls	245	managing image files	116
sample configuration: Internet	252	overview	116
sample configuration: LAN	260	profiles for displaying logos	118
VoIP settings	238		
IR remote control (IR) event		<b>M</b>	
explained	152	Manage Settings	21
user events	152	Manage Settings, Quick Control	23
ISDN		Managing	
inbound phone calls	245	camera settings	133
IT Models	7	image files	116
<b>J</b>		settings	21
Java, operating mode	24	softbutton functions	49
JPEG		Manual Part 1 (Camera Manual)	6
background information	28	Manual Part 2 (Software Manual)	6
MxPEG and audio	26	Manually defining cameras (MxViewer)	14
recording formats	206	Manuals	6
JPEG Quality		Master camera	
and image sizes	27	controlling arming status using a	
JPEG Quality, softbutton	23	master camera	147
JPEG, MxPEG and audio	26	Master/Slave	
JScript, operating mode	24	example: with master/slave arming	
<b>L</b>		148	
Language		example: with one key switch	149
configuring	100	MEGA resolution	27
Language and Entry Page		Menus	
dialog	100	Admin Menu	61
		Setup Menu	62

Messages			
actions, messaging, profiles	169		
display in live image	144		
e-mail (EM) message	175		
general procedure	143		
IP notify (IP) message	175		
overview, conceptional	140		
overview, functional	142		
phone call-out (CL) message	175		
Microphone (MI) event			
explained	154		
hardware sensor events	154		
MOBOTIX MxViewer	11		
Model Features	6		
Model Limitations	7		
Models, Basic	7		
Models, IT	7		
Models, Secure	7		
Models, Web	7		
Modifying			
user groups	82		
users	82		
Motion JPEG			
background information	28		
MPEG			
background information	28		
Multi-channel capability	29		
Multiple cameras			
high image rates	57		
operating	56		
Multiple MOBOTIX cameras	11		
MultiView screens			
controls	37		
Events	37		
Focus	37		
icon	10		
in the browser	37		
Quad	37		
MXNFS Server CD			
recording	205		
MxPEG			
background information	28		
recording formats	206		
video clips with audio	14		
MxPEG ActiveX plug-in	52		
MxPEG and audio			
background information	28		
MxPEG and audio, JPEG	26		
MxPEG off, softbutton	17		
MxPEG on, softbutton	17		
MxPEG video clips	14		
MxViewer			
defining video sources	12		
for fast video streaming	53		
getting the first image	11		
installing and starting	12		
searching MOBOTIX cameras	13		
settings for fast video streaming	58		
starting	54		
<b>N</b>			
Network			
testing connections	80		
<b>O</b>			
Online help	9		
Operating mode			
browser settings	24		
Java	24		
JScript	24		
overview	24		
Server Push	24		
Operating multiple cameras			
overview	56		
Options			
events and storage	32		
exposure settings	124		
Outbound phone calls	242		
Overview			
Admin Menu	61		
camera configuration	60		
configuration file	133		
exposure settings	122		
logos	116		
operating multiple cameras	56		
Quick Installation	64		
sample configuration: IP telephony via Internet	252		
sample configuration: IP telephony via LAN	260		
Setup Menu	62		
telephony features	236		
<b>P</b>			
Pack event story			
Snap Shot recording	211		
Parameters			
automatic exposure	124		
Part 1 (Camera Manual)	6		
Part 2 (Software Manual)	6		
Passive infrared sensor (PI) event			
explained	154		
hardware sensor events	154		
PDA resolution	27		
PDA screen			
accessing	42		
Camera Information	43		
controls	42		
Event List button	43		
Live button	43		



Player button	43	Proxy server problems	46
Query button	43	<b>Q</b>	
Size button	43	Quad, MultiView screen	37
PDA screen	42	Quality Mode, softbutton	18
softbuttons	43	Query button, PDA screen	43
Switch Lens button	43	Quick Controls	15, 21
User Click button	43	Quick Controls	
PDA screen in the browser	10	Backlight	23
Periodic (PE) event		Brightness	23
explained	157	browser	23
time-related events	157	Color Saturation	23
Phone (CL) profiles		deactivating	21
explained	183	Display Mode	23
Phone Call-In, dialog	245	Manage Settings	23
Phone call-out (CL) message		Resolution	23
explained	175	Sharpness	23
Phone profiles		Zoom Control	23
outbound phone calls	242	Quick Installation	
Phone Profiles, dialog	242	configuring the camera	64
Placeholders		Overview	64
examples	111	Quick Installation Pages	66
for displaying dynamic texts	110	<b>R</b>	
Play Last Event, softbutton	18	Random (RD) event	
Play Sound, softbutton	18	explained	158
Playback screen		time-related events	158
controls	30	Recording	
icon	10	concept	204
softbuttons	31	configuring modes	208
Player button, PDA screen	43	events	35
Player controls	30	location: in the MOBOTIX camera	218
Plug-in, ActiveX	52	location: on external file servers	219
Popup blocker problems	46	MXNFS Server CD	205
Problems		overview	204
browser cache	46	storage folder structure	234
browser popup blocker	46	storage location	204
browser security settings	47	Recording begin (RB) event	
browser settings	46	explained	158
proxy server	46	recording events	158
Profiles		Recording end (RE) event	
color	114	explained	158
e-mail (EM) profiles	180	recording events	158
FTP profiles	177	Recording events	
image profiles	192	overview	158
IP notify (IP) profiles	186	RB, recording begin	158
logo profiles	195	RE, recording end	158
logos	118	RH, history recording	158
outbound phone calls	242	RT, recording terminate	158
overview	176	Recording formats	
phone (CL) profiles	183	JPEG	206
time tables	189	MJPEG	206
		Recording mode	
		Continuous	36

History Recording	34	<b>S</b>	
Snap Shot	34	Saving the Settings	25
Recording Modes	34	Screens	
Recording Modes		Guest	44
configuring	208	Live	15
continuous recording	214	MultiView	37
event recording	212	PDA	42
history recording	216	Playback	30
snap shot recording	210	Searching	
Recording off, softbutton	31	for cameras in MxViewer	12
Recording on a Linux/UNIX computer		for cameras in the browser	38
recording types	226	Searching MOBOTIX cameras	
settings: camera	226	(MxViewer)	13
settings: server	229	Secure Models	7
storage folder structure	234	Security	
Recording on a Mac OS X computer		setting up passwords	82
recording types	230	Security setting problems	47
settings: camera	230	Selecting	
settings: server	230	camera	22
SharePoints	231	lens	22
storage folder structure	234	Server Push, operating mode	24
Recording on a Windows computer		Services > Manuals	6
recording types	220	Set Default View, softbutton	20
settings: camera	220	Setting	
settings: server	223	browser frame rate	22
storage folder structure	234	Settings	
Recording on, softbuttons	31	automatic exposure	124
Recording terminate (RT) event		backlight correction	123
explained	158	basic, of the camera	82
recording events	158	browser operating mode	24
Recording types		color profiles	114
location: in the MOBOTIX camera	218	date and time of the camera	92
location: on external file servers	219	exclusion windows	129
on a Linux/UNIX Computer	226	exposure	122
on a Mac OS X Computer	230	exposure windows	126
on a Windows computer	220	for fast video streaming	51
Reducing		language of the camera	100
image noise in dark images	132	logos	116
Reference windows		managing	21
creating video motion reference		managing camera settings	133
windows	164	MxViewer	58
Remote-controlling		passwords	82
camera using a phone	248	recording mode: continuous	
Resolution		recording	214
CIF	27	recording mode: event recording	212
MEGA	27	recording mode: history recording	216
PDA	27	recording mode: snap shot	
VGA	27	recording	210
Resolution, Quick Control	23	recording on Linux/UNIX, camera	
RS232 / COM In (CI) event		settings	226
explained	157	recording on Linux/UNIX, server	
signal and exposure events	157	settings	229
		recording on Mac OS X, camera	
		settings	230

recording on Mac OS X, server settings	230	configuring	48
recording on Windows, camera settings	220	Event Download	19, 36
recording on Windows, server settings	223	Event List	19
saving permanently	25	event softbuttons	18
setting up a softphone: Internet	259	expanded softbuttons	17
setting up a softphone: LAN	267	Fast Mode (30 fps)	17
setting up an IP phone: Internet	257	in the browser	8
setting up an IP phone: LAN	265	JPEG Quality	23
start page of the camera	100	LEDs Blink	18
Supervisor mode	82	Load Default View	20
users, user groups, passwords	82	managing softbutton functions	49
VoIP settings for IP telephony	238	MxPEG off	17
web applications	27	MxPEG on	17
Setup Menu	62	PDA screen	43
Setup Menu, softbutton	16	Play Last Event	18
Several cameras, displaying simultaneously	57	Play Sound	18
SharePoints		Playback screen	31
Recording on a Mac OS X Computer	231	Quality Mode	18
Sharpness, Quick Control	23	Recording off	31
Signal and exposure events		Recording on	31
CI, COM In / RS232	157	Set Default View	20
overview	156	Setup Menu	16
RC, IP receive	156	UC Event	18
SI, signal input (SI2, SI3, SI4)	156	zoom softbuttons	20
Signal input		Softbuttons in the browser	16
arming controlled by signal input	147	Softphone	
Signal input (SI) event		configuring for SIP video telephone	273
explained	156	Software Features	7
signal and exposure events	156	Software Manual Part 2	6
Signal Out (SO) action		Software updates	
explained	172	overview	136
Signals		preparatory steps	136
LEDs of the camera	96	update checklist	139
Simultaneously displaying several cameras	57	updating the camera software	137
SIP telephony		Speak	
video features	268	camera phone mode	241
Size button, PDA screen	43	Start page	
Slave mode		configuring	100
arming control in slave mode	148	Starting	
Snap Shot recording		MxViewer	12, 54
Snap Shot recording	34	Status	
camera settings	210	camera	9
pack event story	211	Status Bar	16
Softbuttons		Storage	
Admin Menu	16	and event options	32
Arm & Record	17	event-controlled	32
Audio on	17	time-controlled	32
Center Pan	20	Storage location	
colored	47	recording, internal and external	204
		Supervisor	
		activating	82
		Switch Lens button, PDA screen	43
		Symbols	
		action	16

event	16	UC, user click	152
<b>T</b>		User groups	
Telephony		adding	82
features	236	creating	82
inbound phone calls	245	modifying	82
overview	236	User interface, camera	8
settings for IP telephony	238	Users	
video telephony	268	adding	82
Temperature (TP) event		creating	82
explained	155	modifying	82
hardware sensor events	155	<b>V</b>	
Testing		Variables	
network connections	80	examples	111
Text		Variables	110
displaying in the camera images	108	for displaying dynamic texts	110
Text & Display Settings, dialog	108	VGA resolution	27
Text display	15	Video motion (VM) event	
Time server		creating video motion windows	153
of the camera, configuring	92	creating video motion windows,	
specifying for the camera	92	with the mouse	160
Time table		explained	159
arming controlled by time table	146	reference windows	164
Time tables		second set (VM2) of video motion	
explained	189	windows	165
Time task (TT) event		video motion events	153
explained	198	Video Motion detection	22
time-related events	157	Video streaming, fast	51
Time zones		Video telephony	
of the camera, configuring	92	example: video intercom system	270
Time-controlled		features	268
e-mail, FTP, storage	32	Visual alarm (VA) action	
Time-related events		explained	174
overview	157	VoIP	
PE, periodic event	157	inbound phone calls	245
RD, random event	158	settings for IP telephony	238
TT, time task event	157	video telephony	268
Typographic Conventions	6	VoIP Settings, dialog	238
<b>U</b>		<b>W</b>	
UC Event, softbutton	18	Web applications	27
Update checklist	139	Web Models	7
Updates		Windows	
checklist	139	exposure windows	23, 125
overview	136	Video Motion detection	22
preparatory steps	136	Windows client (MxViewer)	11
Updating the camera software	137	Windows processes, fast video	
User click (UC) event		streaming	55
explained	152	Working with Profiles	
user events	152	explained	176
User Click button, PDA screen	43	<b>Z</b>	
User events		Zoom buttons	
BT, camera buttons	152	1x Zoom	20
IR, remote control	152	2x Zoom	20
overview	152		



4x Zoom	20
Zoom Control, Quick Control	23
Zoom softbuttons	20

**NUMBERS**

1x Zoom	20
2x Zoom	20
4x Zoom	20











**MOBOTIX ... the new face of IP video**



**All pictures in this manual are genuine MOBOTIX camera images.  
Enjoy the image quality!**

**Manufacturer:**

MOBOTIX AG  
Luxemburger Str. 6  
67657 Kaiserslautern  
Germany

Phone: +49 (631) 3033-103  
Fax: +49 (631) 3033-190

<http://www.mobotix.com>  
[sales@mobotix.com](mailto:sales@mobotix.com)

**CEO:**

Dr. Ralf Hinkel

Court of Registration:  
Amtsgericht Kaiserslautern  
Registration Number: HRB 3724

Tax Code: 19/650/0812/1  
Tax Office: Kaiserslautern

VAT ID: DE 202203501

Download the newest version of this document from:  
[www.mobotix.com](http://www.mobotix.com), **Services** section.



Technical information subject to change without notice!

**Megapixel**

1280 x 960  
software zoom

**30 Frames/s**

VGA (640 x 480)  
10 F/s Mega

-22°F ... +140°F

**Weatherproof**

-30°C to +60°C, IP65  
no heating necessary

IEEE 802.3af

**PoE**

Power over Ethernet  
even in the Winter

Microphone & speaker

**Audio**

bi-directional via IP  
variable framerates

Video SIP Client

**IP Telephony**

alarm notify,  
cam remote control

**Video motion**

multiple windows  
precision pixel-based

Realtime audio

**Recording**

event-ringbuffer  
30 cams each 25 fps

**Live viewing**

30 cams at 25 fps  
all on one screen

**Backlight**

safe using CMOS  
without mechanical iris

Concealed cabling

**Wall bracket**

with cable cover  
for RJ45 wall outlet

**Robust**

no moving parts  
fiber glass housing

# Software Camera Manual

## Part 2

Security-Vision-Systems

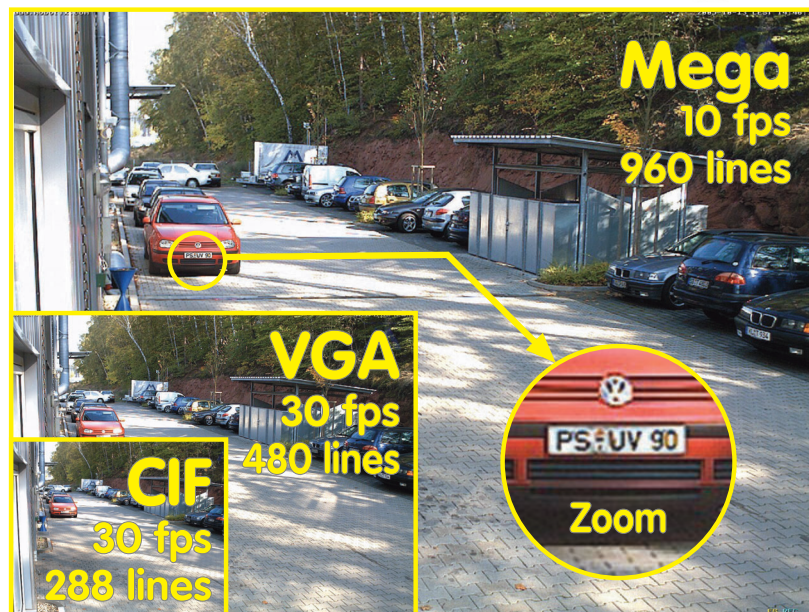

**Complete Integration for Web and Security**

Current PDF File:

[www.mobotix.com](http://www.mobotix.com) > Services > Manuals

MOBOTIX AG • Security-Vision-Systems • Made in Germany

[www.mobotix.com](http://www.mobotix.com) • [sales@mobotix.com](mailto:sales@mobotix.com) • 10.10.2006

**MOBOTIX ... the new face of IP video**